



OPTONICA

LED Lighting for Everyone

Catalogue
2024

OPTONICA LED

Who we are:

OPTONICA is a dynamically evolving trade mark, registered in 2011 on the Bulgarian market and a leader in the technologies of the future: LED LIGHTING! We are a team of highly qualified specialists, always perfecting our knowledge and exploring the world of the rapidly developing LED technologies.

Mission:

Our main goal is to serve and cater for the needs of our potential clients and partners with a large variety and quantity of LED products.. We are sure of the quality of our products and guarantee that our services do not have an alternative, thus making us an indicator and an absolute priority in the precision and execution of our work.

Scope of work:

Our company is a main importer and provider of the richest and most versatile range of LED products. We work with established manufacturers, leaders in the field of the industrial LED revolution.

What we offer:

- New generation of LED lighting with a wide range of application: homes, offices, stores, restaurants, hotels, public and administrative buildings, hospitals, schools, gas stations, trade and industrial building, parks, sport halls and stadiums, lawns, garages and parking lots, billboards and commercial constructions.
- Uncompromising quality and up to 5 year warranty.
- Ecological products and 100% recycling.
- Wide range of products and optimum stock.
- Attractive and reliable terms for partners and distributors.
- Professional attitude and responsibility towards every engagement.

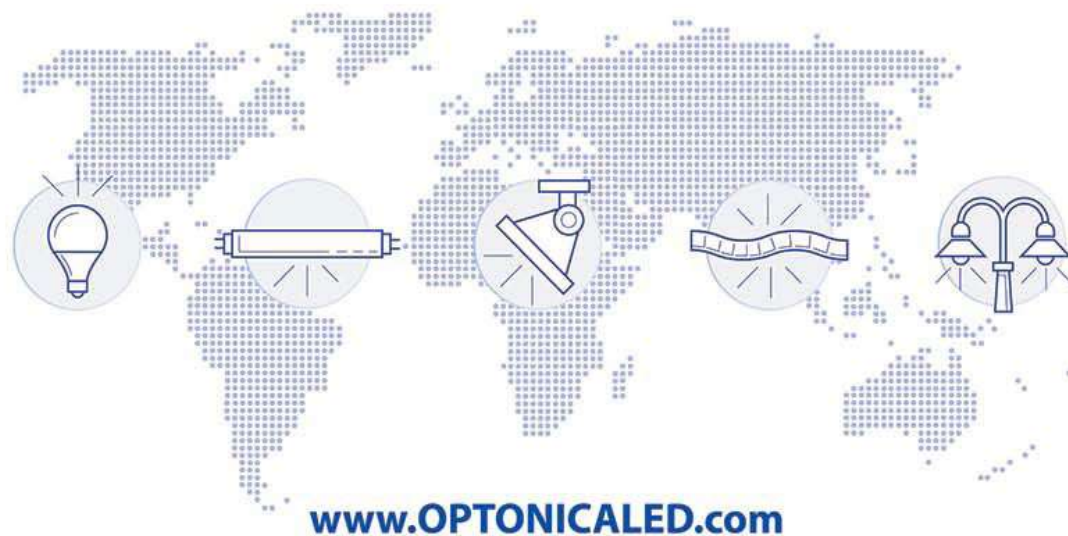

Solar Systems

06-29

LED Spots and
Bulbs

30-68

Fixtures for
Spotlights

68-95

LED Tubes
T5, T8

96-105

LED Fixtures &
Batten Lights

106-113

LED Emergency
Lights

114-119

LED Surface
Panels

120-127



LED Ceiling & Pendants

128-159



LED Panels & Mini Panels

160-191



LED Downlights

192-201



LED Strips
LED Flex Neon
SMD Modules

202-241



LED Power Supplies

242-255



LED Controllers & Accessories

256-279



LED Linear & Track Lights

280-309



LED Floodlights

310-343



LED Industrial & Street Lights

344-369



LED Wall & Step Lights

370-389



LED Outdoor & Garden lights

390-421



LED Motion Sensors

422-433

































































LED Displays & Stage Effects

434-483



OPTONICA Comfort Products

484-499

 E27	E27 Socket Base	8W	Wattage in W	 45°	Tilt angle		Impact Protection		RGB Colors		UV Protection
 E14	E14 Socket Base	810	Total luminous flux Lumens		Motion sensor Sensor		Recyclable plastic		Higher CRI		Fast charging
 GU10	GU10 Socket Base	HIGH	High luminous flux Lumens		ON/OFF switch Switch		Fan included With FAN		Voice assistant alexa		Power surges protection
 GU5.3	MR16 Socket Base	160	Flux per Wattage Lumen/W		DC Current Output DC:12V/24V		Improved Driver EMC Driver		Voice assistant Google Assistant		Plug type EU Plug
 G4	G4 Socket Base		Dimmable		GU10 Holder included GU10 Holder		E27 Socket Base Slim Line		APP control tuya		USB included 2xUSB
 G9	G9 Socket Base		Non-dimmable		E27 Holder included E27 Holder		Magnetic attachment Magnetic		Certificate passed TÜVRheinland		Wireless charger
 B22	B22 Socket Base		Nonwaterproof IP20		Solar Panel included Solar Power		Open cable, in length 1m		German standard		Operating current DC 5V
 B15	B15 Socket Base		Waterproof IP65		Battery included Battery		Linkable products Linkable		Fire-resistance rating 90 Minutes		Flame Machine
 G5.3	G5.3 Socket Base		Pcs per box/set 3 PCS PACK		Rechargeable battery Rechargeable		Eye care LED LED		Emergency light		Confetti Machine Confetti
 GX53	GX53 Socket Base		Beam angle in degrees 180°		Roll length in m. 5m-Roll		Music control Music		MAX operating power 300W LED Power		Fog Machine CO2-FOG
 5 Years Warranty	Warranty Period		Cutout size 150x150mm		SMD diodes per m. 120 pcs		Track Base width M35 TRACK		Rechargeable cycles >1500 Cycles		Haze Machine HAZE



OPTONICA

SOLAR POWER SYSTEM

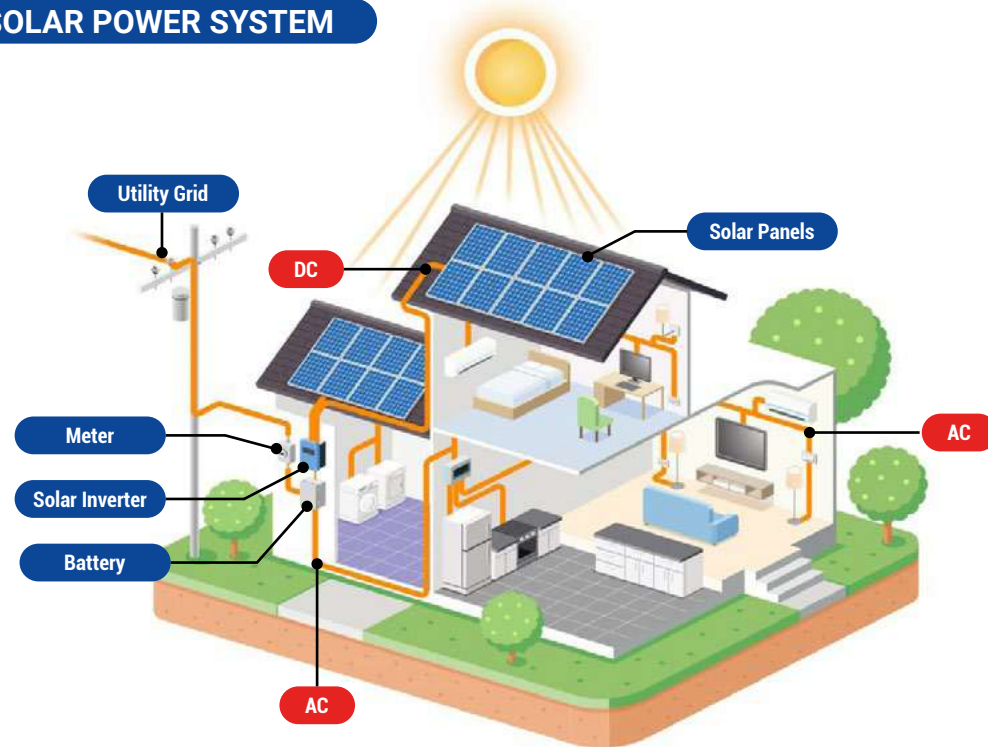

What components make up a solar panel system?

Solar panel installations are very straightforward systems. There are only four main components to any solar panel system, and no moving parts, making them very efficient to install and maintain. The four components of a solar panel system are:

Solar photovoltaic panels—to convert solar energy into electricity

Battery—to store DC electricity

Inverters—to convert DC electricity into AC electricity

Racking and mounting systems—to affix your solar panels to your roof (or to the ground, depending upon your installation type)

Performance monitoring systems—to track and monitor the output and health of your solar panels and inverters

OPTONICA

SOLAR POWER PRODUCTS



How does solar power work?

Solar power works by converting energy from the sun into power. There are two forms of energy generated from the sun for our use – electricity and heat.

Both are generated through the use of solar panels, which range in size from residential rooftops to 'solar farms' stretching over acres of rural land.

Is solar power a clean energy source?

Yes, solar power is a renewable and infinite energy source that creates no harmful greenhouse gas emissions – as long as the sun continues to shine, energy will be released.

The carbon footprint of solar panels is already quite small, as they last for 25 years plus with no loss in efficiency. And the materials used in the panels are increasingly recycled, so the carbon footprint will continue to shrink.

When was solar power discovered?

Solar energy was used by humans as early as the 7th century B.C., when humans used sunlight to light fires by reflecting the sun's rays onto shiny objects. Later, in 3rd century B.C., the Greeks and Romans harnessed solar power with mirrors to light torches for religious ceremonies.

In 1839 and at the age of just 19, French physicist Edmond Becquerel discovered the photovoltaic (PV) effect while experimenting with a cell made of metal electrodes in a conducting solution. He noted that the cell produced more electricity when it was exposed to light – it was a photovoltaic cell.

In 1954 PV technology was born when Daryl Chapin, Calvin Fuller and Gerald Pearson developed the silicon PV cell at Bell Labs in 1954 – the first solar cell capable of absorbing and converting enough of the sun's energy into power to run everyday electrical equipment.

Today satellites, spacecraft orbiting Earth, are powered by solar energy.

How exactly is electricity from solar energy produced?

Solar panels are usually made from silicon installed in a metal panel frame with a glass casing. When photons, or particles of light, hit the thin layer of silicon on the top of a solar panel, they knock electrons off the silicon atoms.

This PV charge creates an electric current (specifically, direct current or DC), which is captured by the wiring in solar panels. This DC electricity is then converted to alternating current (AC) by an inverter. AC is the type of electrical current used when you plug appliances into normal wall sockets.

PORTABLE POWER STATION

PURE SINE WAVE AC OUTPUT

IDEAL FOR OUTDOOR & RECREATION



400W

Cell Capacity: 400W/320Wh
 DC Input: 12V-24V/0-10A (120W Max)
 AC Output: 230Vac 400W
 DC Output: 12V/0-10A
 Cigar Socket Output: 13.3V/10A
 USB-A Output: 5V/2.4A
 USB-C Output: 20V/3A max
 LED Flashlight: 3W

SKU: 9418

600W

Cell Capacity: 600W/512Wh
 DC Input: 12V-24V/0-10A (120W Max)
 AC Output: 230Vac 600W
 DC Output: 12V/0-10A
 Cigar Socket Output: 13.3V/10A
 USB-A Output: 5V/2.4A
 USB-C Output: 20V/5A max
 LED Flashlight: 3W

SKU: 9419

1000W

Cell Capacity: 1000W/1036.8Wh
 DC Input: 12V-24V/0-10A (200W Max)
 AC Output: 230Vac 1000W
 DC Output: 12V/0-10A
 Cigar Socket Output: 13.3V/10A
 USB-A Output: 5V/2.4A
 USB-C Output: 20V/5A max
 LED Flashlight: 3W

SKU: 9420

2000W

Cell Capacity: 2000W/2096Wh
 DC Input: 12V-65V/0-10A (650W Max)
 AC Output: 230Vac 2000W
 DC Output: 12V-65V/0-10A
 Cigar Socket Output: 13V/10A
 USB-A Output: 5V/2.4A
 USB-C Output: 20V/5A max
 LED Flashlight: 3W
 Wireless Charge: (20W Max)

SKU: 9421

Bags for Portable Station

For 400W - SKU: 9429
 For 600W - SKU: 9428
 For 1000W - SKU: 9422
 For 2000W - SKU: 9423



MONOCRYSTALLINE PORTABLE SOLAR PANEL 120W

Convert Efficiency: up to 21%
 ETFE high Light Transmittance Film
 Output: 1. MC4 18V/6.6A Max
 2. USB-A QC 3.0 24W Max
 3. Type-C: PD45W Max
 Material: PET Monocrystalline solar panel
 Intelligent charging chip

SKU: 9400

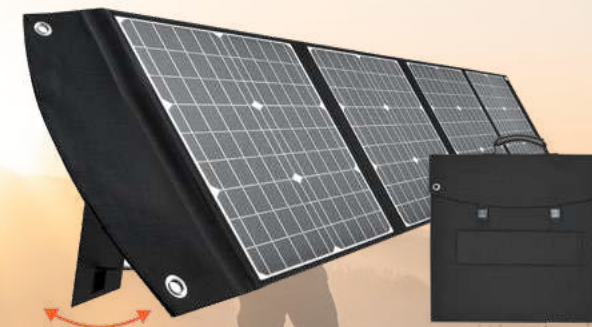

MONOCRYSTALLINE PORTABLE SOLAR PANEL 200W

Convert Efficiency: up to 21%
 ETFE high Light Transmittance Film
 Output: 1. MC4 18V/11.1A Max
 2. USB-A QC 3.0 24W Max
 3. Type-C: PD45W Max
 Material: PET Monocrystalline solar panel
 Intelligent charging chip

SKU: 9401



MONOCRYSTALLINE PORTABLE SOLAR PANEL 400W

Convert Efficiency: up to 21%
 ETFE high Light Transmittance Film
 Output: MC4 36V/6.6A Max
 Material: PET Monocrystalline solar panel
 Intelligent charging chip

SKU: 9402

PV SOLAR PANELS

OPTONICA
SOLAR

PV SOLAR PANELS

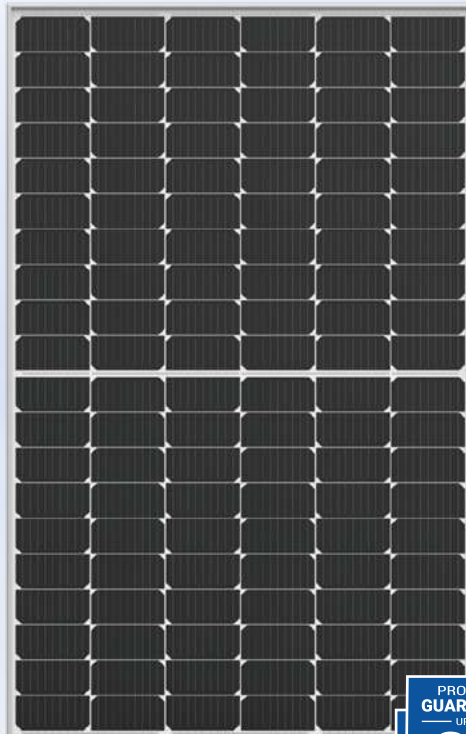
OPTONICA
SOLAR

MONOCRYSTALLINE SOLAR PV MODULE

410W

PV Model	FV410-A1	SKU:9404
Rated Maximum Power (Pmax)		410W
Power Sorting		0~+5W
Voltage at Pmax (Vmp)		31.40V
Current at Pmx (IMP)		13.06A
Open-Circuit Current (Voc)		37.30V
Short-Circuit Current (Isc)		13.93A
Pv Module Classification		CLASS II
Maximum System Voltage		1500V
Maximum Series Fuse Rating		25A
Operating Temperature		-40~85° C
Dimensions (mm)		1722x1134x30mm
Pmax /Voc / Isc Tolerance		± 3%

Tested at STC:1000W/m ; AM1.5; Cell temperature 25C°

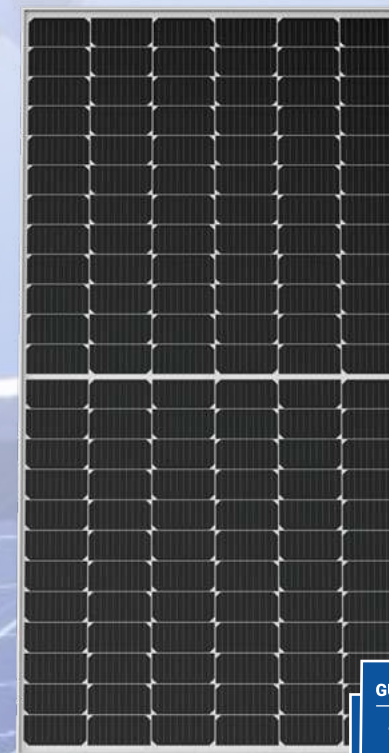

MONOCRYSTALLINE SOLAR PV MODULE

450W

PV Model	FV450-A1	SKU:9403
Rated Maximum Power (Pmax)		450W
Power Sorting		0~+5W
Voltage at Pmax (Vmp)		42.10V
Current at Pmx (IMP)		10.69A
Open-Circuit Current (Voc)		49.84V
Short-Circuit Current (Isc)		11.20A
Pv Module Classification		CLASS II
Maximum System Voltage		1500V
Maximum Series Fuse Rating		15A
Operating Temperature		-40~85° C
Dimensions (mm)		2094x1038x35mm
Pmax /Voc / Isc Tolerance		± 3%

Tested at STC:1000W/m ; AM1.5; Cell temperature 25C°



Micro Inverter

1. Input: 2*MC4 / PV 2*210-400W
2. Output: 230Vac 600W
3. MPPT 25-55V 2*13A
4. Unit: 212*230*40mm 3.15kg
5. IP67

SKU: 9431
SKU: 9424

SKU: 9425

SKU: 9426

SKU: 9427

PV SOLAR PANELS

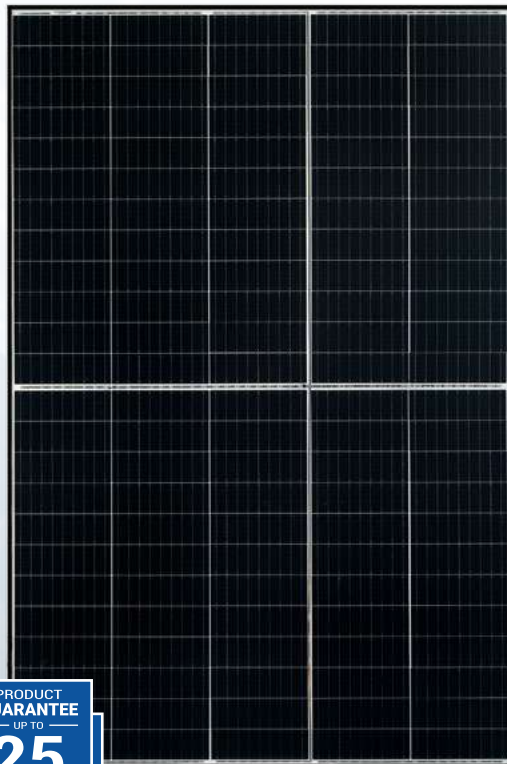

MONOCRYSTALLINE SOLAR PV MODULE

410W

PV Model	FV410-A1	SKU:9406
Rated Maximum Power (Pmax)		410W
Power Sorting		0~+5W
Voltage at Pmax (Vmp)		34.89V
Current at Pmx (IMP)		11.76A
Open-Circuit Current (Voc)		41.90V
Short-Circuit Current (Isc)		12.47A
Pv Module Clasification		CLASS II
Maximum System Voltage		1500V
Maximum Series Fuse Rating		20A
Operating Temperature		-40~85° C
Dimensions (mm)		1754x1096x30mm
Pmax /Voc / Isc Tolerance		± 3%

Tested at STC:1000W/m ; AM1.5; Cell temperature 25C°



SKU: 9451,9453



4 mm² ; 6 mm²

SKU: 9452,9454



4 mm² ; 6 mm²

SKU: 9457



SKU: 9458



PV SOLAR PANELS



MONOCRYSTALLINE SOLAR PV MODULE

450W

PV Model	FV450-A1	SKU:9407
Rated Maximum Power (Pmax)		450W
Power Sorting		0~+5W
Voltage at Pmax (Vmp)		41.30V
Current at Pmx (IMP)		10.90A
Open-Circuit Current (Voc)		49.70V
Short-Circuit Current (Isc)		11.50A
Pv Module Clasification		CLASS II
Maximum System Voltage		1500V
Maximum Series Fuse Rating		20A
Operating Temperature		-40~85° C
Dimensions (mm)		2108x1048x35mm
Pmax /Voc / Isc Tolerance		± 3%

Tested at STC:1000W/m ; AM1.5; Cell temperature 25C°



SKU: 9455 ; 9456



SKU: 9434



PV POWER OPTIMIZER



SKU: 9464

PV SOLAR PANELS

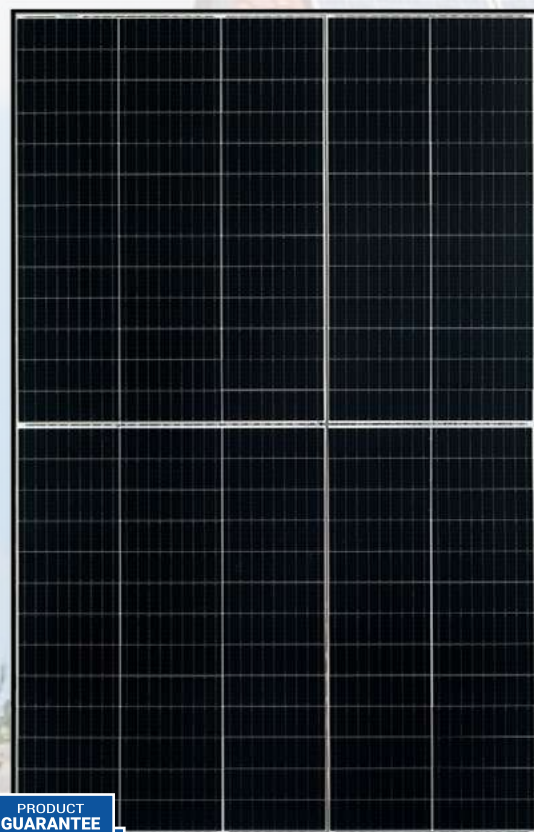
PV SOLAR PANELS

**MONOCRYSTALLINE
SOLAR PV MODULE**
445W

PV Model	FV445-A1	SKU:9408
Rated Maximum Power (Pmax)		445W
Power Sorting		0~+5W
Voltage at Pmax (Vmp)		45.09V
Current at Pmx (IMP)		12.57A
Open-Circuit Current (Voc)		37.54V
Short-Circuit Current (Isc)		11.86A
Pv Module Clasification		CLASS I
Maximum System Voltage		1500V
Maximum Series Fuse Rating		20A
Operating Temperature		-40~85° C
Dimensions (mm)		1894x1096x30mm
Pmax /Voc / Isc Tolerance		± 3%

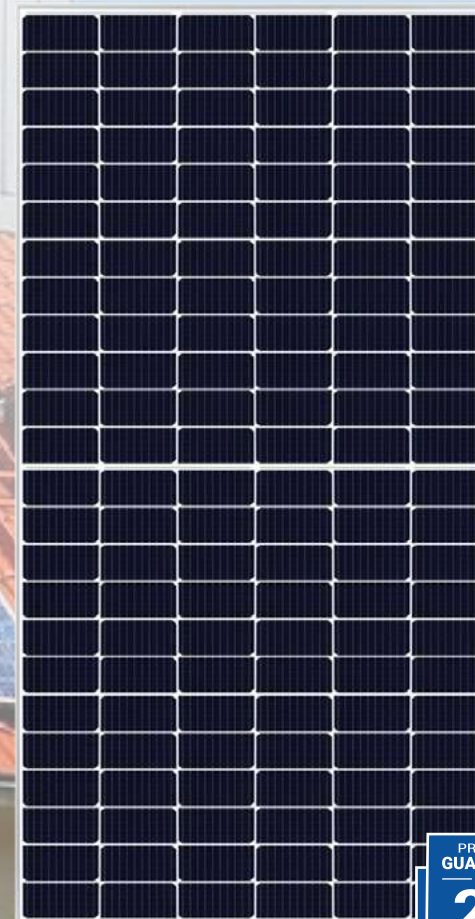
Tested at STC:1000W/m ; AM1.5; Cell temperature 25C°

**MONOCRYSTALLINE
SOLAR PV MODULE**
550W

PV Model	FV550-A1	SKU:9405
Rated Maximum Power (Pmax)		550W
Power Sorting		0~+5W
Voltage at Pmax (Vmp)		42.20V
Current at Pmx (IMP)		13.04A
Open-Circuit Current (Voc)		49.80V
Short-Circuit Current (Isc)		13.94A
Pv Module Clasification		CLASS II
Maximum System Voltage		1500V
Maximum Series Fuse Rating		25A
Operating Temperature		-40~85° C
Dimensions (mm)		2279x1134x35mm
Pmax /Voc / Isc Tolerance		± 3%

Tested at STC:1000W/m ; AM1.5; Cell temperature 25C°



PV SOLAR PANELS



PV SOLAR PANELS

**MONO HALF-CUT MODULE
BLACK FRAME**
405W

UL-405-108HV

MBB 182mm Cell

PV Model	SKU:9411
Rated Maximum Power (Pmax)	405W
Power Sorting	0~+5W
Voltage at Pmax (Vmp)	31.3V
Current at Pmx (IMP)	12.94A
Open-Circuit Current (Voc)	37.3V
Short-Circuit Current (Isc)	13.69A
Module Efficiency STC	20.74
Maximum System Voltage	1500V
Maximum Series Fuse Rating	25A
Operating Temperature	-40~85° C
Dimensions (mm)	2279/1134/35mm
Pmax /Voc / Isc Tolerance	± 3%

Tested at STC:1000W/m ; AM1.5; Cell temperature 25C°



Lower LCOE
 Lower shading and resistive loss
 Lower temperature coefficient



Anti-PID (potential induced degradation)
 Passed anti-PID test under 85% damp heat,
 85% relative humidity for 96 hours

**MONO HALF-CUT MODULE
SILVER FRAME**
455W

UL-455M-144HV

MBB 166mm Cell

PV Model	SKU:9410
Rated Maximum Power (Pmax)	455W
Power Sorting	0~+5W
Voltage at Pmax (Vmp)	41.1V
Current at Pmx (IMP)	11.07A
Open-Circuit Current (Voc)	49.9V
Short-Circuit Current (Isc)	11.64A
Module Efficiency STC	20.93
Maximum System Voltage	1500V
Maximum Series Fuse Rating	20A
Operating Temperature	-40~85° C
Dimensions (mm)	2094x1038x35mm
Pmax /Voc / Isc Tolerance	± 3%

Tested at STC:1000W/m ; AM1.5; Cell temperature 25C°



Lower LCOE
 Lower shading and resistive loss
 Lower temperature coefficient



Anti-PID (potential induced degradation)
 Passed anti-PID test under 85% damp heat,
 85% relative humidity for 96 hours

PV SOLAR PANELS



PV SOLAR PANELS

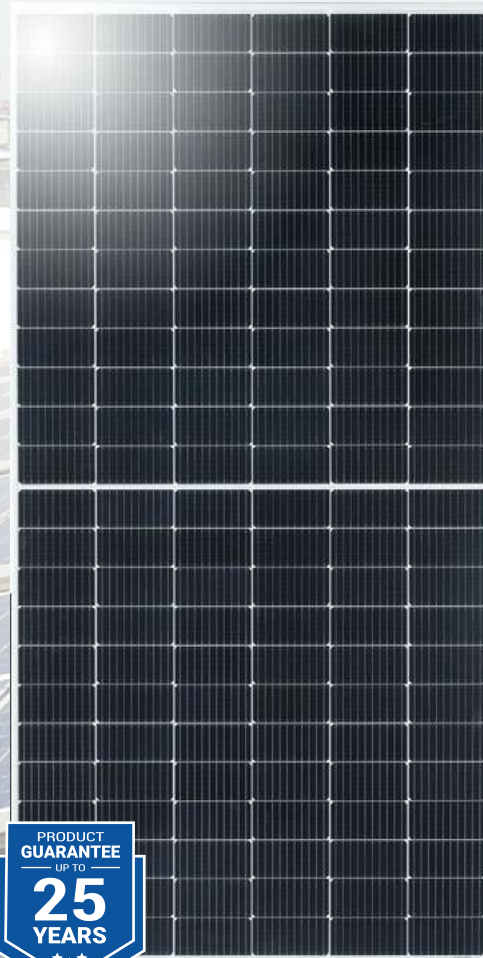

BIFACIAL MONO PERC MODULE

UL-550M-144HV

550W

MBB 182mm Cell

PV Model	SKU:9412
Rated Maximum Power (Pmax)	550W
Power Sorting	0~+5W
Voltage at Pmax (Vmp)	41.9V
Current at Pmx (IMP)	13.13A
Open-Circuit Current (Voc)	50V
Short-Circuit Current (Isc)	13.75A
Module Efficiency STC	21.28
Maximum System Voltage	1500V
Maximum Series Fuse Rating	30A
Operating Temperature	-40~85° C
Dimensions (mm)	2279/1134/35mm
Pmax /Voc / Isc Tolerance	± 3%

Tested at STC:1000W/m ; AM1.5; Cell temperature 25C°



Lower LCOE
Lower shading and resistive loss
Lower temperature coefficient



Anti-PID (potential induced degradation)
Passed anti-PID test under 85% damp heat,
85% relative humidity for 96 hours

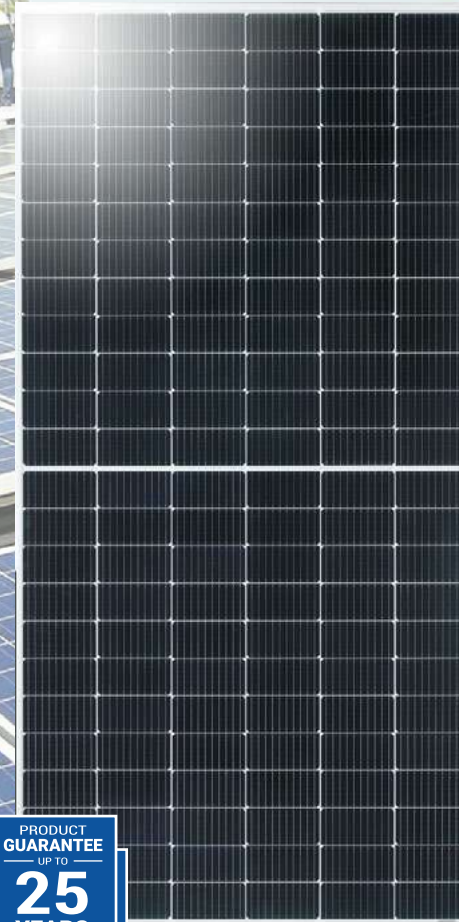

DOUBLE-GLASS BIFACIAL MODULE

UL-570M-144DG

**N-TYPE 570
TOPCON**

MBB 182mm Cell

PV Model	SKU:9413
Rated Maximum Power (Pmax)	570W
Power Sorting	0~+5W
Voltage at Pmax (Vmp)	42.2/
Current at Pmx (IMP)	13.51
Open-Circuit Current (Voc)	50.7
Short-Circuit Current (Isc)	14.23
Module Efficiency STC	22.07%
Maximum System Voltage	1500V
Maximum Series Fuse Rating	30A
Operating Temperature	-40~85° C
Dimensions (mm)	2278/1134/35mm
Pmax /Voc / Isc Tolerance	± 3%

Tested at STC:1000W/m ; AM1.5; Cell temperature 25C°



Lower LCOE
Lower shading and resistive loss
Lower temperature coefficient



Anti-PID (potential induced degradation)
Passed anti-PID test under 85% damp heat,
85% relative humidity for 96 hours



OPTONICA
SOLAR 
**Double Headed Electric Photovoltaic Brush
 5.5M Glass Fiber Handle AC220 or 110V AC**

Applicable Voltage	110-240V	Material	Alu/Carbon fiber
Utilization Voltage	24V	Wall thickness	1-1.2mm
Power	52.8W*2	Diameter	43mm
Speed	128rpm	Length	5.5m
Torsion	1.2 N.m	Brush Size	280mm

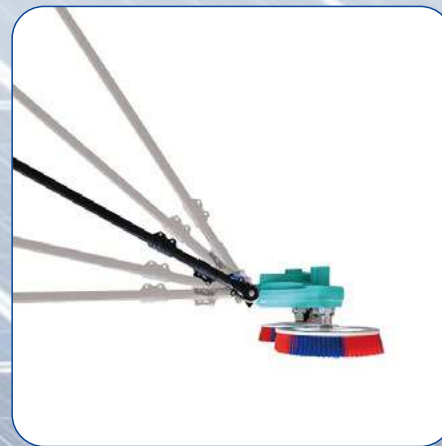
SKU: 9656

Accessories

- Battery*1
- Adapter*1
- Water pipe and accessories*1
- Backpack*1
- Push button switch spring wire*1
- Telescopic rod*1
- Brush head assembly*1 set
(including 1 pcs brush discs)

OPTONICA
SOLAR 
Solar Panel Cleaning Robot - Watering

**SINGLE SOLAR PANEL CLEANING ROBOT
 2384mm 150W 24V10Ah**
SKU: 9658

PV Module Range	2384mm Single PV Panel
Traveling Speed	15-20 m/min
Generator Power	150W
Water Used Per Hour	330L/H
Solar Panel(W)	27W
Battery Capacity(Ah)	24V/10Ah
Cleaning Mode	Dry/Watering Cleaning
Other Functions	Speed Adjust/Direction Adjust

**DOUBLE SOLAR PANEL CLEANING ROBOT
 2384mm 200W 24V20Ah**
SKU: 9659

PV Module Range	2384mm Double PV Panel
Traveling Speed	15-20 m/min
Generator Power	200W
Water Used Per Hour	330L/H
Solar Panel(W)	27W
Battery Capacity(Ah)	24V/10Ah
Cleaning Mode	Dry/Watering Cleaning
Other Functions	Speed Adjust/Direction Adjust

RECHARGEABLE LITHIUM BATTERY SYSTEM



BATTERY LiFePo4

	10.94kWh	10.24kWh	5.12kWh
Model	SKU:9471	SKU:9472	SKU:9473
Nominal Capacity	228Ah	200Ah	100Ah
Nominal Energy	10.94kWh	10.24kWh	5.12kWh
Nominal Voltage	48Vdc	51.2Vdc	51.2Vdc
Discharge Current	150A	150A	100A
Cell	BYD	EVE	EVE
Ingress Protection	IP65	IP65	IP65
Weight	90kg	90kg	42.2kg

MULTI-FUNCTION ELECTRICAL ENERGY METERS



Single-phase Multi-Function electrical energy meter

230V/100A/RS485/MID Certification
SKU: 9461



Three-phase Multi-Function electrical energy meter

3x230V/100A/RS485/MID certification
SKU: 9462

CT Three-phase Multi-Function electrical energy meter

3x230V/1A or 5A/RS485/MID certification
SKU: 9463



ONE-PHASE HYBRID INVERTERS

5kW

6kW



PRODUCT
GUARANTEE
UP TO
10
YEARS

Model	SKU: 9437	SKU:9438
Battery Input Data		
Battery Type	Lead-acid or Li-Ion	
Battery Voltage Range (V)	40~60	
Max. Charging Current (A)	120	135
Max. Discharging Current (A)	120	135
External Temperature Sensor	Yes	
Charging Curve	3 Stages / Equalization	
Charging Strategy for Li-Ion Battery	Self-adaption to BMS	
PV String Input Data		
Max. DC Input Power (W)	6500	7800
Rated PV Input Voltage (V)	370 (125~500)	
Start-up Voltage (V)	125	
MPPT Voltage Range (V)	150-425	
Full Load DC Voltage Range (V)	300-425	
PV Input Current (A)	13+13	
Max. PV I _{sc} (A)	17+17	
No.of MPP Trackers	2	
No.of Strings per MPP Tracker	1	
AC Output Data		
Rated AC Output and UPS Power (W)	5000	6000
Max. AC Output Power (W)	5500	6600
AC Output Rated Current (A)	22.7/217	27.3/261
Max. AC Current (A)	25/239	30/287
Max. Continuous AC Passthrough (A)	40	
Peak Power (off grid)	2 time of rated power, 10S	
Power Factor	0.8 leading to 0.8 lagging	
Output Frequency and Voltage	50/60Hz; L/N/PE 220/230Vac (single phase)	
Grid Type	Single Phase	
Total Harmonic Distortion (THD)	<3% (of nominal power)	
DC current injection	<0.5% I _n	



THREE-PHASE HYBRID INVERTERS

8kW

10kW



PRODUCT
GUARANTEE
UP TO
10
YEARS

Model	SKU: 9436	SKU:9435
Battery Input Data		
Battery Type	Lead-acid or Li-Ion	
Battery Voltage Range (V)	40~60	
Max. Charging Current (A)	190	210
Max. Discharging Current (A)	190	210
External Temperature Sensor	Yes	
Charging Curve	3 Stages / Equalization	
Charging Strategy for Li-Ion Battery	Self-adaption to BMS	
PV String Input Data		
Max. DC Input Power (W)	10400	13000
Rated PV Input Voltage (V)	550 (160~800)	
Start-up Voltage (V)	160	
MPPT Voltage Range (V)	200-650	
Full Load DC Voltage Range (V)	350-650	
PV Input Current (A)	13+13	26+13
Max. PV I _{sc} (A)	17+17	34+17
No.of MPP Trackers	2	
No.of Strings per MPP Tracker	1	2+1
AC Output Data		
Rated AC Output and UPS Power (W)	8000	10000
Max. AC Output Power (W)	8800	11000
AC Output Rated Current (A)	12.1/11.6	15.2/14.5
Max. AC Current (A)	18.2/17.4	22.7/21.7
Max. Continuous AC Passthrough (A)	45	
Peak Power (off grid)	2 time of rated power, 10 S	
Power Factor	0.8 leading to 0.8 lagging	
Output Frequency and Voltage	50/60Hz; 3L/N/PE 220/380, 230/400Vac	
Grid Type	Three Phase	
Total Harmonic Distortion (THD)	<3% (of nominal power)	
DC current injection	<0.5% I _n	



Three Phase On-Grid Solar Inverter



MODEL	SKU:9481	SKU:9482	SKU:9483	SKU:9484	SKU:9485
Input(DC)	Max 12.8KW	Max 16KW	Max 48KW	Max 80KW	Max 150kW
Max. DC Voltage	1100V	1100V	1100V	1100V	1100V
Nominal Voltage	600V	600V	600V	600V	620V
Start Voltage	160V	160V	250V	250V	250V
MPPT Voltage Range	180V-1000V	180V-1000V	200V-1000V	200V-1000V	180V-1000V
Number of MPPT Tracker	2	2	3	4	9
Strings Per MPPT Tracker	1	1	2	3/2/3/2	2
Max. Input Current Per MPPT	14A/14A	14A/14A	26A	39A/26A/39A/26A	26A
Max. Short-circuit Current Per MPPT	18A/18A	18A/18A	32A	48A/32A/48A/32A	40A
Output(AC)					
Nominal AC Output Power	8kW	10kW	30kW	50kW	100kW
Maximum AC Output Power	8.8kVA	11kVA	33kVA	55kVA	110kVa
Nominal AC Voltage	400Vac 3L/N/PE	400Vac 3L/N/PE	400Vac 3L/N/PE	230Vac/400Vac	400Vac 3L/N/PE
AC Grid Frequency Range	50/60Hz	50/60Hz	50/60Hz	50/60Hz	50/60Hz
Maximum Output Current	12.8A	15.9A	48.3A	79.7A	158.8A
Power Factor(Φ)	0.8leading-0.8lagging	0.8leading-0.8lagging	0.8leading-0.8lagging	0.8leading-0.8lagging	0.8leading-0.8lagging
THDi	<3%	<3%	<3%	<3%	<3%
Efficiency					
Max. Efficiency	98.7%	98.7%	98.6%	98.7%	98.7%
General Specifications					
Dimensions W x H x D	481x395x195mm	481x395x195mm	600x430x230mm	650x450x260mm	1050x660x330mm
Operating Temperature Range	-30°C~+60°C	-25°C~+60°C	-25°C~+60°C	-25°C~+60°C	-25°C~+60°C
Cooling Type	Natural cooling	Natural cooling	Smart Cooling	Smart Cooling	Smart Cooling
IP Class	IP66	IP66	IP66	IP66	IP66



Three Phase On-Grid Solar Inverter



MODEL	SKU:9491	SKU:9492	SKU:9493	SKU:9494
Input(DC)	10KW	30KW	40KW	120KW
Max. DC Voltage	1100V	1100V	1100V	1100V
Nominal Voltage	620V	600V	600V	620V
Start Voltage	180V	180V	180V	250V
MPPT Voltage Range	140V-1000V	200V-1000V	200V-1000V	200V-1000V
Number of MPPT Tracker	2	3	2	10
Strings Per MPPT Tracker	1	2	1	2
Max. Input Current Per MPPT	15A	30A	30A	30A
Max. Short-circuit Current Per MPPT	20A	50A	50A	50A
Output(AC)				
Nominal AC Output Power	10000W	30000W	40000W	120kW
Maximum AC Output Power	11000Va	33000Va	44000Va	121kVa
Nominal AC Voltage	400V 3L+N	400V 3L+N	400V 3L+N	480V 3W+PE
AC Grid Frequency Range	50/60Hz	50/60Hz	50/60Hz	50/60Hz
Maximum Output Current	16.0A	47.7A	63.6A	174.6A
Power Factor(Φ)	0.8leading-0.8lagging	0.8leading-0.8lagging	0.8leading-0.8lagging	0.8leading-0.8lagging
THDi	<3%	<3%	<3%	<3%
Efficiency				
Max. Efficiency	98.6%	98.7%	98.7%	98.7%
General Specifications				
Dimensions W x H x D	380x483x161mm	380x483x227mm	380x483x227mm	1055x700x336mm
Operating Temperature Range	-25°C~+60°C	-25°C~+60°C	-25°C~+60°C	-25°C~+60°C
Cooling Type	Natural cooling	Fan cooling	Fan cooling	Fan cooling
IP Class	IP66	IP66	IP66	IP66

Deye



RECHARGEABLE LITHIUM BATTERY SYSTEM

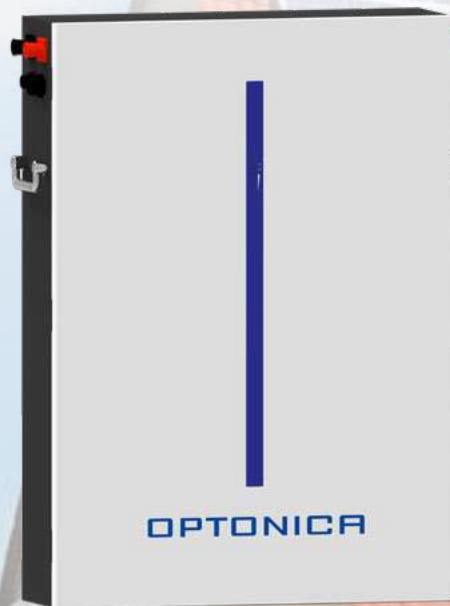

BATTERY LiFePo4 6.14kWh

Model	SKU:9439
Nominal Capacity	120Ah
Nominal Energy	6.14kWh
Nominal Voltage	51.2Vdc
Operating Voltage Range	43.2~57.6Vdc
Nominal Charge/Discharge Current	60A
Ingress Protection	IP65
Operating Temperature(Charge)	0~+55 C°
Operating Temperature(Discharge)	-20~+55 C°
Storage Temperature	-20~+35 C°
DimmensionS	475x720x145mm
Weight Approximate	58 Kg

SKU: 9603 END CLAMP



SKU: 9604 MIDDLE CLAMP



SKU: 9609 L Foot Group



SKU: 9606 T-Fixture Bolt



SKU: 9607 Self-Tapping Screw



SKU: 9608 Self-Tapping Screw for Wood



SKU: 9605 Tile Hook



SKU: 9611 Hanger Bolt with L Foot



SKU: 9615 Grounding Plate



SKU: 9601-2.2m Rail

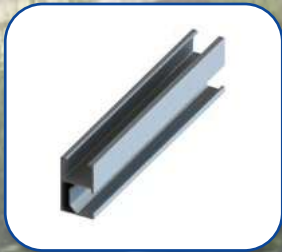

SKU: 9602-1.2m Rail

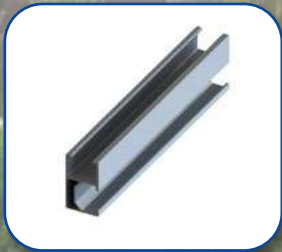

SKU: 9610-Rail Joiner 200mm



SKU: 9616 Tilt Mount-Adjustable



SKU: 9613-9614 Rear Leg



SKU: 9612 Front Leg





LED BULBS GOLDEN GLASS



Innovative line of half-glass covered bulbs combine the classic retro appearance with modern power-saving technology and creating a cosy ambience in both homes, villa or restaurants and bars.

Features:

- Up to 80% power saving impact
- 2500K warm white light
- Half silver or half golden cover
- E27 socket
- Stylish retro look
- Standard bulb head – A60 or G95

Application:

- Home use on standard sockets
- Outdoor use in enclosed fixtures
- Discrete or additional lighting





LED Bulbs PS160 Filament

8W E27

GOLDEN GLASS

Watts	8W	CRI	Ra>80
Input Voltage	AC : 175-265V	IP Rating	IP20
Flux	810lm	Dimension	ø160x315 mm
Beam Angle	270°	Body Type	PS160

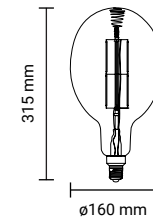
 SKU: 1790
 1800K

LED Bulbs BD200 Filament

8W E27

GOLDEN GLASS

Watts	8W	CRI	Ra>80
Input Voltage	AC : 175-265V	IP Rating	IP20
Flux	810lm	Dimension	ø200x410 mm
Beam Angle	270°	Body Type	BD200
Socket	E27	Dimmable	YES

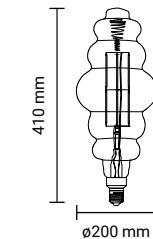
 SKU: 1791
 1800K

LED Bulbs G200 Filament

8W E27

GOLDEN GLASS

Watts	8W	CRI	Ra>80
Input Voltage	AC : 175-265V	IP Rating	IP20
Flux	810lm	Dimension	ø200x300 mm
Beam Angle	270°	Body Type	G200
Socket	E27	Dimmable	YES

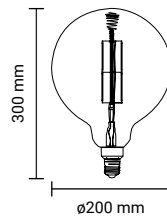
 SKU: 1792
 1800K

LED Bulbs MS200 Filament

8W E27

GOLDEN GLASS

Watts	8W	CRI	Ra>80
Input Voltage	AC : 175-265V	IP Rating	IP20
Flux	810lm	Dimension	ø200x210 mm
Beam Angle	270°	Body Type	MS200
Socket	E27	Dimmable	YES

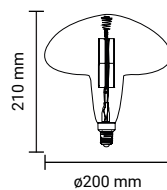
 SKU: 1793
 1800K

LED Bulbs Filament

4W E27

HALF GOLDEN GLASS

Watts	4W	CRI	Ra>80
Input Voltage	AC : 175-265V	IP Rating	IP20
Flux	400lm	Dimension	ø95x135 mm
Beam Angle	180°	Body Type	G95
Socket	E27	Dimmable	NO

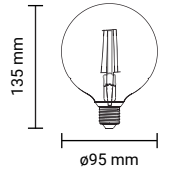
 SKU: 1889
 1800K

LED Bulbs Filament

4W E27

HALF SILVER GLASS

Watts	4W	CRI	Ra>80
Input Voltage	AC : 175-265V	IP Rating	IP20
Flux	400lm	Dimension	ø95x135 mm
Beam Angle	180°	Body Type	G95
Socket	E27	Dimmable	NO

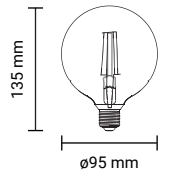
 SKU: 1887
 1800K

LED Bulbs Filament

7W E27

HALF GOLDEN GLASS

Watts	7W	CRI	Ra>80
Input Voltage	AC : 175-265V	IP Rating	IP20
Flux	800lm	Dimension	ø95x135 mm
Beam Angle	180°	Body Type	G95
Socket	E27	Dimmable	NO

SKU: 1890 Warm White 2700K 3800156618909

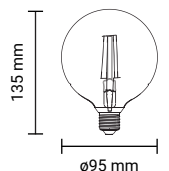

LED Bulbs Filament

7W E27

HALF SILVER GLASS

Watts	7W	CRI	Ra>80
Input Voltage	AC : 175-265V	IP Rating	IP20
Flux	800lm	Dimension	ø95x135 mm
Beam Angle	180°	Body Type	G95
Socket	E27	Dimmable	NO

 SKU: 1888
 1800K

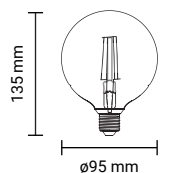
 SKU: 1890
 1800K



LED Bulbs Filament

4W E27

HALF GOLDEN GLASS

Watts 4W
 Input Voltage AC : 175-265V
 Flux 400lm
 Beam Angle 180°
 Socket E27

SKU: 1893
 ■ 2700K

CRI Ra>80
 IP Rating IP20
 Dimension ø60x105 mm
 Body Type A60
 Dimmable NO

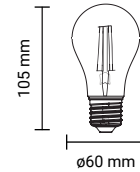

LED ST64 Bulbs Filament

4W E27

GOLDEN GLASS

Watts 4W
 Input Voltage AC : 220-240V
 Flux 400lm
 Beam Angle 270°
 Socket E27

SKU: 1795
 ■ 2500K

CRI Ra>80
 IP Rating IP20
 Dimension ø64x140 mm
 Body Type ST64
 Dimmable NO

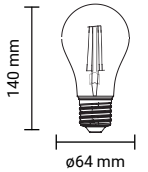

LED Bulbs Filament

4W E27

HALF SILVER GLASS

Watts 4W
 Input Voltage AC : 175-265V
 Flux 400lm
 Beam Angle 180°
 Socket E27

SKU: 1879
 ■ 2700K

CRI Ra>80
 IP Rating IP20
 Dimension ø60x105 mm
 Body Type A60
 Dimmable NO

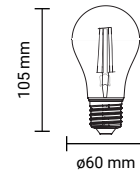

LED ST64 Bulbs Filament

6W E27

GOLDEN GLASS

Watts 6W
 Input Voltage AC : 220-240V
 Flux 540lm
 Beam Angle 270°
 Socket E27

SKU: 1306
 ■ 2500K

CRI Ra>80
 IP Rating IP20
 Dimension ø64x140 mm
 Body Type ST64
 Dimmable NO

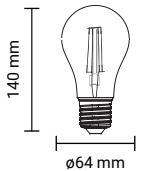

LED Bulbs Filament

7W E27

HALF GOLDEN GLASS

Watts 7W
 Input Voltage AC : 175-265V
 Flux 800lm
 Beam Angle 180°
 Socket E27

SKU: 1896
 ■ 2700K

CRI Ra>80
 IP Rating IP20
 Dimension ø60x105 mm
 Body Type A60
 Dimmable NO

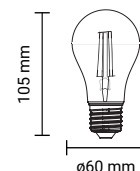

LED ST64 Bulbs Filament

8W E27

GOLDEN GLASS

Watts 8W
 Input Voltage AC : 220-240V
 Flux 700lm
 Beam Angle 270°
 Socket E27

SKU: 1305
 ■ 2500K

CRI Ra>80
 IP Rating IP20
 Dimension ø64x140 mm
 Body Type ST64
 Dimmable NO

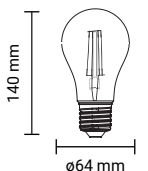

LED Bulbs Filament

7W E27

HALF SILVER GLASS

Watts 7W
 Input Voltage AC : 175-265V
 Flux 800lm
 Beam Angle 180°
 Socket E27

SKU: 1880
 ■ 2700K

CRI Ra>80
 IP Rating IP20
 Dimension ø60x105 mm
 Body Type A60
 Dimmable NO

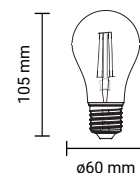

LED ST64 Bulbs Filament

8W E27

GOLDEN GLASS

Watts 8W
 Input Voltage AC : 220-240V
 Flux 700lm
 Beam Angle 270°
 Socket E27

SKU: 1322
 ■ 2500K

CRI Ra>80
 IP Rating IP20
 Dimension ø64x140 mm
 Body Type ST64
 Dimmable YES

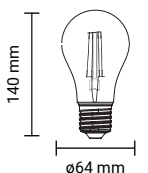



LED A60 Bulbs Filament
4W E27

Watts 4W
 Input Voltage AC : 175-265V
 Flux 470lm
 Beam Angle 300°
 Socket E27

SKU: 1857 6000K
 SKU: 1858 4500K
 SKU: 1859 2700K

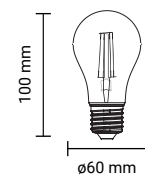
CRI Ra>80
 IP Rating IP20
 Dimension ø60x100 mm
 Body Type A60
 Dimmable NO

LED A60 Bulbs Filament
8W E27

Watts 8W
 Input Voltage AC : 220-240V
 Flux 810lm
 Beam Angle 300°
 Socket E27

SKU: 1310 6000K
 SKU: 1311 4500K
 SKU: 1312 2700K

CRI Ra>80
 IP Rating IP20
 Dimension ø60x110 mm
 Body Type A60
 Dimmable NO

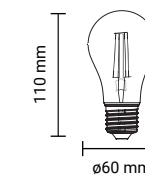
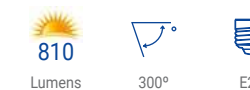
LED A60 Bulbs Filament
4W E27

Watts 4W
 Input Voltage AC : 175-265V
 Flux 400lm
 Beam Angle 300°
 Socket E27

SKU: 1899
 2700K

CRI Ra>80
 IP Rating IP20
 Dimension ø60x106 mm
 Body Type A60
 Dimmable YES

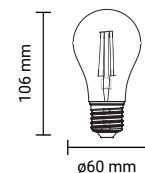
LED A60 Bulbs Filament
8W E27

Watts 8W
 Input Voltage AC : 220-240V
 Flux 810lm
 Beam Angle 300°
 Socket E27

SKU: 1323
 2700K

CRI Ra>80
 IP Rating IP20
 Dimension ø60x110 mm
 Body Type A60
 Dimmable YES

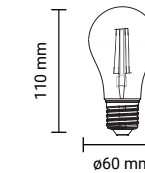
LED A60 Bulbs Filament
5W E27

Watts 5W
 Input Voltage AC : 175-265V
 Flux 600lm
 Beam Angle 300°
 Socket E27

SKU: 1854 6000K
 SKU: 1855 4500K
 SKU: 1856 2700K

CRI Ra>80
 IP Rating IP20
 Dimension ø60x106 mm
 Body Type A60
 Dimmable NO

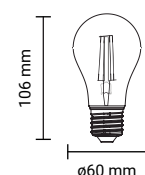
LED A60 Bulbs Filament
8W E27
GOLDEN GLASS

Watts 8W
 Input Voltage AC : 220-240V
 Flux 700lm
 Beam Angle 300°
 Socket E27

SKU: 1796
 2700K

CRI Ra>80
 IP Rating IP20
 Dimension ø60x105 mm
 Body Type A60
 Dimmable NO

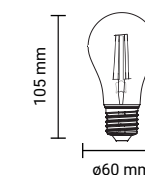
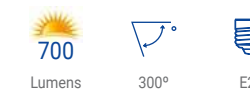
LED A60 Bulbs Filament
6W E27

Watts 6W
 Input Voltage AC : 220-240V
 Flux 630lm
 Beam Angle 300°
 Socket E27

SKU: 1308 4000K
 SKU: 1309 2700K

CRI Ra>80
 IP Rating IP20
 Dimension ø60x105 mm
 Body Type A60
 Dimmable NO

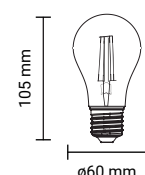
LED A60 Bulbs Filament
8W E27
GOLDEN GLASS

Watts 8W
 Input Voltage AC : 220-240V
 Flux 720lm
 Beam Angle 300°
 Socket E27

SKU: 1324
 2700K

CRI Ra>80
 IP Rating IP20
 Dimension ø60x105 mm
 Body Type A60
 Dimmable YES

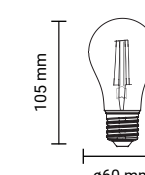

LED A60 Bulbs Filament
10W E27

Watts	10W	CRI	Ra>80
Input Voltage	AC : 220-240V	IP Rating	IP20
Flux	1350lm	Dimension	ø60x110 mm
Beam Angle	300°	Body Type	A60
Socket	E27	Dimmable	NO

SKU: 1313 SKU: 1314 SKU: 1315
 6000K 4500K 2700K

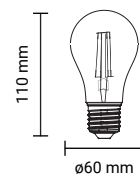
LED G45 Bulbs Filament
4W E27

Watts	4W	CRI	Ra>80
Input Voltage	AC : 175-265V	IP Rating	IP20
Flux	400lm	Dimension	ø45x78 mm
Beam Angle	300°	Body Type	G45
Socket	E27	Dimmable	NO

SKU: 1867 SKU: 1868 SKU: 1869
 6000K 4500K 2700K

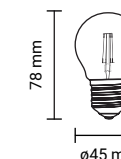
LED A65 Bulbs Filament
12W E27

Watts	12W	CRI	Ra>80
Input Voltage	AC : 220-240V	IP Rating	IP20
Flux	1500lm	Dimension	ø65x126 mm
Beam Angle	300°	Body Type	A60
Socket	E27	Dimmable	NO

SKU: 1316 SKU: 1317 SKU: 1318
 6000K 4500K 2700K

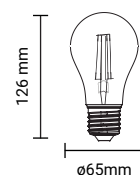
LED G45 Bulbs Filament
4W E27

Watts	4W	CRI	Ra>80
Input Voltage	AC : 175-265V	IP Rating	IP20
Flux	400lm	Dimension	ø45x78 mm
Beam Angle	300°	Body Type	G45
Socket	E27	Dimmable	NO

SKU: 1325
 2700K

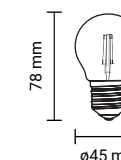
LED A65 Bulbs Filament
14W E27

Watts	14W	CRI	Ra>80
Input Voltage	AC : 220-240V	IP Rating	IP20
Flux	2000lm	Dimension	ø65x126 mm
Beam Angle	300°	Body Type	A60
Socket	E27	Dimmable	NO

SKU: 1319 SKU: 1320 SKU: 1321
 6000K 4500K 2700K

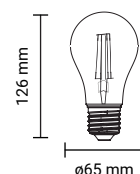
LED G45 Bulbs Filament
4W E27
GOLDEN GLASS

Watts	4W	CRI	Ra>80
Input Voltage	AC : 175-265V	IP Rating	IP20
Flux	320lm	Dimension	ø45x78 mm
Beam Angle	300°	Body Type	G45
Socket	E27	Dimmable	YES

SKU: 1326
 2700K

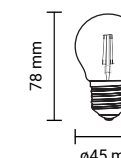
LED G45 Bulbs Filament
2W E27

Watts	2W	CRI	Ra>80
Input Voltage	AC : 175-265V	IP Rating	IP20
Flux	200lm	Dimension	ø45x78 mm
Beam Angle	300°	Body Type	G45
Socket	E27	Dimmable	NO

SKU: 1864 SKU: 1865 SKU: 1866
 6000K 4500K 2700K

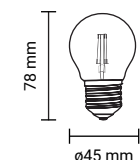
LED G125 Bulbs Filament
4W E27
GOLDEN GLASS

Watts	4W	CRI	Ra>80
Input Voltage	AC : 220-240V	IP Rating	IP20
Flux	400lm	Dimension	ø95x135 mm
Beam Angle	270°	Body Type	G95
Socket	E27	Dimmable	NO

SKU: 1794
 2700K

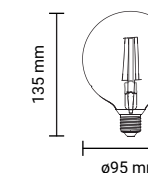



**LED G125 Bulbs Filament
4W E27**

Watts 4W
Input Voltage AC : 175-265V
Flux 400lm
Beam Angle 300°
Socket E27

SKU: 1863 SKU: 1862
■ 4500K ■ 2700K

CRI Ra>80
IP Rating IP20
Dimension ø125x165 mm
Body Type G125
Dimmable NO

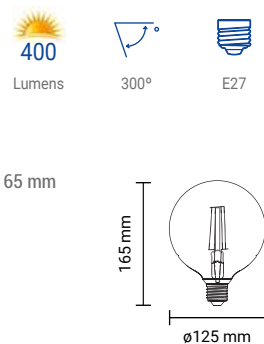

**LED G45 Bulbs Filament
4W E14**

Watts 4W
Input Voltage AC : 175-265V
Flux 400lm
Beam Angle 300°
Socket E14

SKU: 1417
■ 2700K

CRI Ra>80
IP Rating IP20
Dimension ø45x78 mm
Body Type G45
Dimmable YES



**LED G125 Bulbs Filament
6.5W E27**

Watts 6.5W
Input Voltage AC : 175-265V
Flux 810lm
Beam Angle 300°
Socket E27

SKU: 1861 SKU: 1860
■ 4500K ■ 2700K

CRI Ra>80
IP Rating IP20
Dimension ø125x165 mm
Body Type G125
Dimmable NO

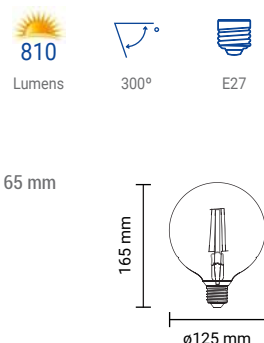

**LED G45 Bulbs Filament
4W E14
GOLDEN GLASS**

Watts 4W
Input Voltage AC : 175-265V
Flux 400lm
Beam Angle 300°
Socket E14

SKU: 1492
■ 2500K

CRI Ra>80
IP Rating IP20
Dimension ø45x78 mm
Body Type G45
Dimmable NO



**LED G45 Bulbs Filament
2W E14**

Watts 2W
Input Voltage AC : 175-265V
Flux 200lm
Beam Angle 300°
Socket E14

SKU: 1474 SKU: 1475 SKU: 1476
■ 6000K ■ 4500K ■ 2700K

CRI Ra>80
IP Rating IP20
Dimension ø45x78 mm
Body Type G45
Dimmable NO

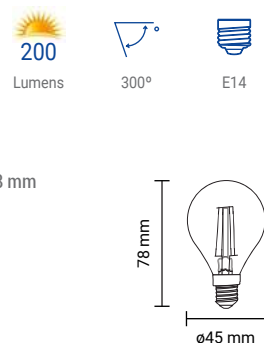

**LED G45 Bulbs Filament
4W E14
GOLDEN GLASS**

Watts 4W
Input Voltage AC : 175-265V
Flux 350lm
Beam Angle 300°
Socket E14

SKU: 1418
■ 2500K

CRI Ra>80
IP Rating IP20
Dimension ø45x78 mm
Body Type G45
Dimmable YES



**LED G45 Bulbs Filament
4W E14**

Watts 4W
Input Voltage AC : 175-265V
Flux 400lm
Beam Angle 300°
Socket E14

SKU: 1477 SKU: 1478 SKU: 1479
■ 6000K ■ 4500K ■ 2700K

CRI Ra>80
IP Rating IP20
Dimension ø45x78 mm
Body Type G45
Dimmable NO

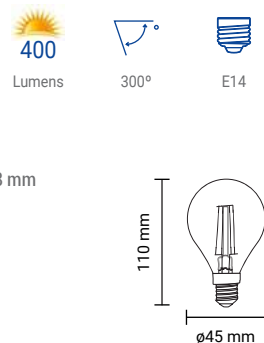

**LED R50 Bulbs Filament
5W E14**

Watts 5W
Input Voltage AC : 175-265V
Flux 600lm
Beam Angle 70°
Socket E14

SKU: 1872
■ 2700K

CRI Ra>80
IP Rating IP20
Dimension ø50x86 mm
Body Type R50
Dimmable NO



**LED C35 Candle Filament
4W E14**

Watts	4W	CRI	Ra>80
Input Voltage	AC : 175-265V	IP Rating	IP20
Flux	400lm	Dimension	ø35x98 mm
Beam Angle	300°	Body Type	C35
Socket	E14	Dimmable	NO

SKU: 1470 SKU: 1471 SKU: 1472
 6000K 4500K 2700K

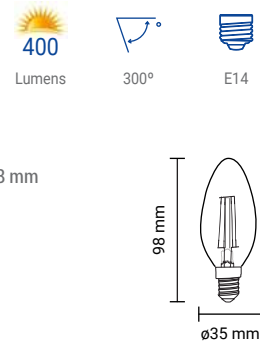
**LED C35 Candle Filament
4W E14**

Watts	4W	CRI	Ra>80
Input Voltage	AC : 175-265V	IP Rating	IP20
Flux	400lm	Dimension	ø35x98 mm
Beam Angle	300°	Body Type	C35
Socket	E14	Dimmable	YES

SKU: 1469 SKU: 1473
 4500K 2700K

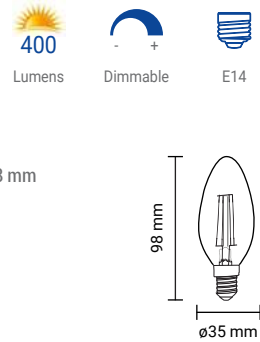
**LED C35 Candle Filament
4W E14
GOLDEN GLASS**

Watts	4W	CRI	Ra>80
Input Voltage	AC : 175-265V	IP Rating	IP20
Flux	400lm	Dimension	ø35x98 mm
Beam Angle	300°	Body Type	C35
Socket	E14	Dimmable	NO

SKU: 1490
 2500K

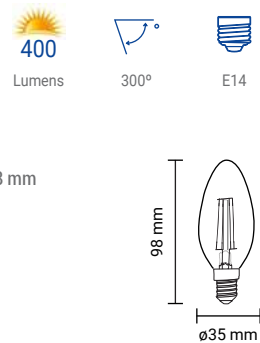
**LED C35 Twist Candle Filament
4W E14**

Watts	4W	CRI	Ra>80
Input Voltage	AC : 175-265V	IP Rating	IP20
Flux	400lm	Dimension	ø35x98 mm
Beam Angle	300°	Body Type	C35 Twist
Socket	E14	Dimmable	NO

SKU: 1413
 2700K

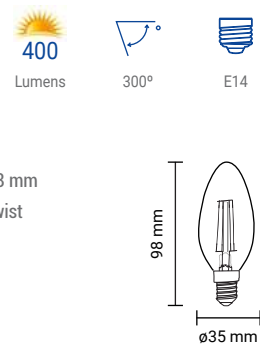
**LED C35 Tip Candle Filament
4W E14**

Watts	4W	CRI	Ra>80
Input Voltage	AC : 175-265V	IP Rating	IP20
Flux	400lm	Dimension	ø35x115 mm
Beam Angle	300°	Body Type	C35 Tip
Socket	E14	Dimmable	NO

SKU: 1480 SKU: 1481 SKU: 1482
 6000K 4500K 2700K

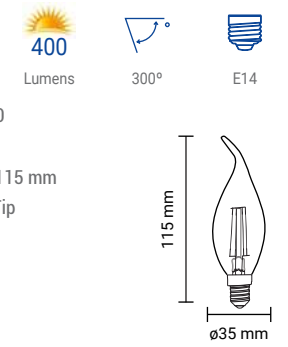
**LED C35 Tip Candle Filament
4W E14**

Watts	4W	CRI	Ra>80
Input Voltage	AC : 175-265V	IP Rating	IP20
Flux	400lm	Dimension	ø35x115 mm
Beam Angle	300°	Body Type	C35 Tip
Socket	E14	Dimmable	YES

SKU: 1415
 2700K

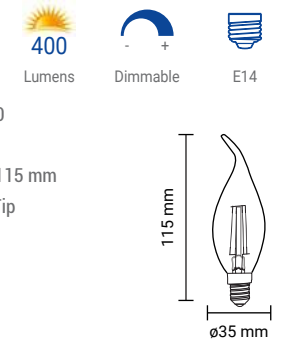
**LED C35 Tip Candle Filament
4W E14
GOLDEN GLASS**

Watts	4W	CRI	Ra>80
Input Voltage	AC : 175-265V	IP Rating	IP20
Flux	400lm	Dimension	ø35x120 mm
Beam Angle	300°	Body Type	C35 Tip
Socket	E14	Dimmable	YES

SKU: 1416
 2500K

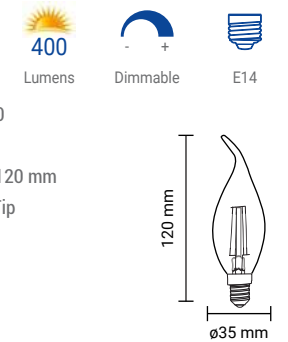
**LED C35 Tip Candle Filament
4W E14
GOLDEN GLASS**

Watts	4W	CRI	Ra>80
Input Voltage	AC : 175-265V	IP Rating	IP20
Flux	400lm	Dimension	ø35x120 mm
Beam Angle	300°	Body Type	C35 Tip
Socket	E14	Dimmable	NO

SKU: 1491
 2500K

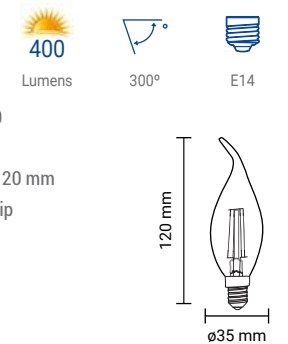



LED C35 Candle Twist Bulbs Filament

4W E14

Watts	4W	CRI	Ra>80
Input Voltage	AC : 175-265V	IP Rating	IP20
Flux	400lm	Dimension	ø35x115 mm
Beam Angle	300°	Body Type	C35T Twist
Socket	E14	Dimmable	NO

SKU: 1414
2700K

400 Lumens 300° E14

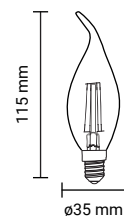

LED C35 Candle Filament

6W E14

Watts	6W	CRI	Ra>80
Input Voltage	AC : 175-265V	IP Rating	IP20
Flux	730lm	Dimension	ø35x98 mm
Beam Angle	300°	Body Type	C35
Socket	E14	Dimmable	NO

SKU: 1410 6000K
SKU: 1411 4500K
SKU: 1412 2700K

730 Lumens 300° E14

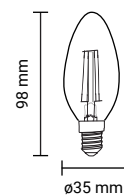

LED Bulb A60 Motion Sensor

7W E27

Watts	7W	CRI	Ra>80
Input Voltage	AC : 220-240V	IP Rating	IP20
Flux	560lm	Dimension	ø60x123 mm
Beam Angle	270°	Body Type	A60
Socket	E27	Dimmable	NO

SKU: 1710 6000K
SKU: 1711 4500K

560 Lumens 270° E27

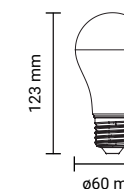

LED Bulb A60

8.5W E27

Watts	8.5W	CRI	Ra>80
Input Voltage	AC : 220-240V	IP Rating	IP20
Flux	806lm	Dimension	ø60x108 mm
Beam Angle	270°	Body Type	A60
Socket	E27	Dimmable	NO

SKU: 1351 6000K
SKU: 1352 4500K
SKU: 1353 2700K

806 Lumens 270° E27

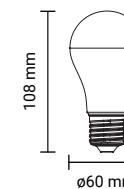



**LED Bulb A60
8.5W E27**

Watts 8.5W
Input Voltage AC : 220-240V
Flux 806lm
Beam Angle 270°
Socket E27

SKU: 1341 6000K
SKU: 1342 4500K
SKU: 1343 2700K

CRI Ra>80
IP Rating IP20
Dimension ø60x108 mm
Body Type A60
Dimmable NO

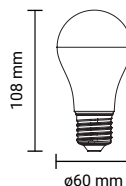

**LED Bulb A60
11W E27**

Watts 11W
Input Voltage AC : 220-240V
Flux 1055lm
Beam Angle 270°
Socket E27

SKU: 1704 6000K
SKU: 1705 4500K
SKU: 1706 2700K

CRI Ra>80
IP Rating IP20
Dimension ø60x110 mm
Body Type A60
Dimmable YES

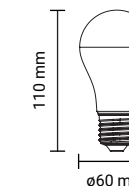

**LED Bulb A60
9W E27**

Watts 9W
Input Voltage AC : 220-240V
Flux 806lm
Beam Angle 270°
Socket E27

SKU: 1701 6000K
SKU: 1702 4500K
SKU: 1703 2700K

CRI Ra>80
IP Rating IP20
Dimension ø60x108 mm
Body Type A60
Dimmable YES

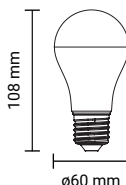

**LED Bulb A60
12W E27**

Watts 12W
Input Voltage AC : 175-265V
Flux 1055lm
Beam Angle 270°
Socket E27

SKU: 1851 6000K

CRI Ra>80
IP Rating IP20
Dimension ø60x120 mm
Body Type A60
Dimmable YES

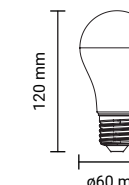

**LED Bulb A60
10W E27**

Watts 10W
Input Voltage AC : 220-240V
Flux 806lm
Beam Angle 270°
Socket E27

SKU: 1849 6000K

CRI Ra>80
IP Rating IP20
Dimension ø60x110 mm
Body Type A60
Dimmable YES

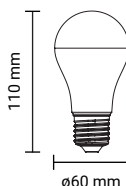

**LED Bulb A60
14W E27**

Watts 14W
Input Voltage AC : 220-240V
Flux 1380lm
Beam Angle 270°
Socket E27

SKU: 1357 6000K
SKU: 1358 4500K
SKU: 1359 2700K

CRI Ra>80
IP Rating IP20
Dimension ø60x108 mm
Body Type A60
Dimmable NO

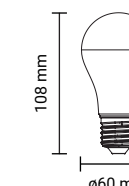

**LED Bulb A60
10.5W E27**

Watts 10.5W
Input Voltage AC : 220-240V
Flux 1055lm
Beam Angle 270°
Socket E27

SKU: 1354 6000K
SKU: 1355 4500K
SKU: 1356 2700K

CRI Ra>80
IP Rating IP20
Dimension ø60x108 mm
Body Type A60
Dimmable NO

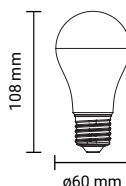

**LED Bulb A65
17W E27**

Watts 17W
Input Voltage AC : 220-240V
Flux 1710lm
Beam Angle 270°
Socket E27

SKU: 1360 6000K
SKU: 1361 4500K
SKU: 1362 2700K

CRI Ra>80
IP Rating IP20
Dimension ø65x134 mm
Body Type A65
Dimmable NO

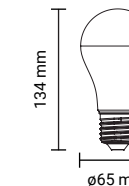

LED Bulb A65
19W E27

Watts	19W	CRI	Ra>80
Input Voltage	AC : 220-240V	IP Rating	IP20
Flux	1950lm	Dimension	ø65x138 mm
Beam Angle	270°	Body Type	A65
Socket	E27	Dimmable	NO

SKU: 1363 SKU: 1364 SKU: 1365
 ■ 6000K ■ 4500K ■ 2700K

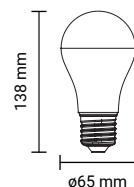
LED Bulb G45
3.5W E27

Watts	3.5W	CRI	Ra>80
Input Voltage	AC : 175-265V	IP Rating	IP20
Flux	300lm	Dimension	ø45x75 mm
Beam Angle	180°	Body Type	G45
Socket	E27	Dimmable	NO

SKU: 1344 SKU: 1345 SKU: 1346
 ■ 6000K ■ 4500K ■ 2700K

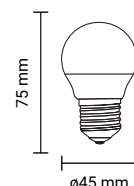
LED Bulb G45
4W E27

Watts	4W	CRI	Ra>80
Input Voltage	AC : 175-265V	IP Rating	IP20
Flux	320lm	Dimension	ø45x75 mm
Beam Angle	180°	Body Type	G45
Socket	E27	Dimmable	NO

SKU: 1838 SKU: 1839 SKU: 1840
 ■ 6000K ■ 4500K ■ 2700K

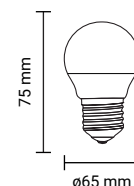
LED Bulb G45
5.5W E27

Watts	5.5W	CRI	Ra>80
Input Voltage	AC : 175-265V	IP Rating	IP20
Flux	450lm	Dimension	ø45x75 mm
Beam Angle	180°	Body Type	G45
Socket	E27	Dimmable	NO

SKU: 1327 SKU: 1328 SKU: 1329
 ■ 6000K ■ 4500K ■ 2700K

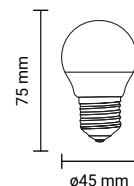
LED Bulb G45
8W E27

Watts	8W	CRI	Ra>80
Input Voltage	AC : 175-265V	IP Rating	IP20
Flux	710lm	Dimension	ø45x75 mm
Beam Angle	180°	Body Type	G45
Socket	E27	Dimmable	NO

SKU: 1336 SKU: 1337 SKU: 1338
 ■ 6000K ■ 4500K ■ 2700K

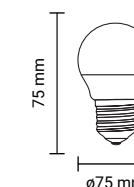
LED Bulb G95
12W E27

Watts	12W	CRI	Ra>80
Input Voltage	AC : 175-265V	IP Rating	IP20
Flux	1155lm	Dimension	ø95x138 mm
Beam Angle	270°	Body Type	A60
Socket	E27	Dimmable	NO

SKU: 1841 SKU: 1842 SKU: 1843
 ■ 6000K ■ 4500K ■ 2700K

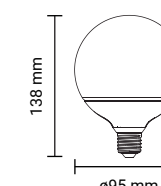
LED Bulb G120
15W E27

Watts	15W	CRI	Ra>80
Input Voltage	AC : 175-265V	IP Rating	IP20
Flux	1500lm	Dimension	ø120x155 mm
Beam Angle	270°	Body Type	G120
Socket	E27	Dimmable	NO

SKU: 1845 SKU: 1846 SKU: 1847
 ■ 6000K ■ 4500K ■ 2700K

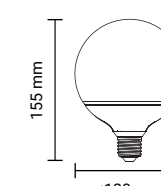
LED Bulb G120
18W E27

Watts	18W	CRI	Ra>80
Input Voltage	AC : 175-265V	IP Rating	IP20
Flux	1820lm	Dimension	ø125x172 mm
Beam Angle	270°	Body Type	120
Socket	E27	Dimmable	NO

SKU: 1884 SKU: 1885 SKU: 1886
 ■ 6000K ■ 4500K ■ 2700K

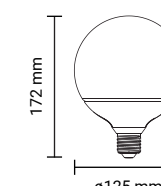

LED Bulb G63
6W E27

Watts 6W
 Input Voltage AC : 220-240V
 Flux 480lm
 Beam Angle 200°
 Socket E27

SKU: 1876 6000K
 SKU: 1877 4500K
 SKU: 1878 2700K

CRI Ra>80
 IP Rating IP20
 Dimension ø63x100 mm
 Body Type A60
 Dimmable NO

480
Lumens

200°

E27

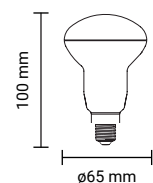
LED Spot PAR30
30W E27

Watts 30W
 Input Voltage AC : 220-240V
 Flux 2400lm
 Beam Angle 30°
 Socket E27

SKU: 1528 6000K
 SKU: 1529 4500K
 SKU: 1530 2700K

CRI Ra>80
 IP Rating IP20
 Dimension ø95x130 mm
 Body Type PAR30
 Dimmable NO

2400
Lumens

30°

E27

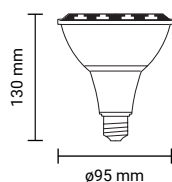
LED Bulb Mosquito Zapper
8W+2W E27

Watts 8W+2W Zapper
 Input Voltage AC : 100-265V
 Flux 640lm
 Beam Angle 180°
 Socket E27

SKU: 1819
 4500K

CRI Ra>80
 IP Rating IP20
 Dimension ø95x172 mm
 Body Type G95
 Dimmable NO

640
Lumens

270°

E27

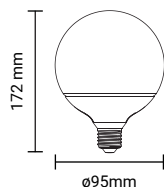

LED Candle C37
3.5W E14

Watts 3.5W
 Input Voltage AC : 175-265V
 Flux 300lm
 Beam Angle 180°
 Socket E14

SKU: 1407 6000K
 SKU: 1408 4500K
 SKU: 1409 2700K

CRI Ra>80
 IP Rating IP20
 Dimension ø37x100 mm
 Body Type C37
 Dimmable NO

300
Lumens

180°

E14

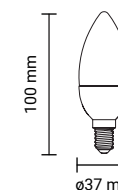

LED Candle C37
3.7W E14

Watts 3.7W
 Input Voltage AC : 175-265V
 Flux 320lm
 Beam Angle 180°
 Socket E14

SKU: 1422 6000K
 SKU: 1423 4500K
 SKU: 1424 2700K

CRI Ra>80
 IP Rating IP20
 Dimension ø37x100 mm
 Body Type C37
 Dimmable NO

320
Lumens

180°

E14

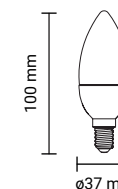

LED Candle C37
5.5W E14

Watts 5.5W
 Input Voltage AC : 175-265V
 Flux 450lm
 Beam Angle 180°
 Socket E14

SKU: 1425 6000K
 SKU: 1426 4500K
 SKU: 1427 2700K

CRI Ra>80
 IP Rating IP20
 Dimension ø37x100 mm
 Body Type C37
 Dimmable NO

450
Lumens

180°

E14

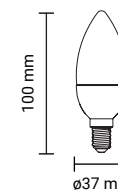

Dimmable

LED Candle C37
6W E14

Watts 6W
 Input Voltage AC : 175-265V
 Flux 480lm
 Beam Angle 180°
 Socket E14

SKU: 1464 6000K
 SKU: 1465 4500K
 SKU: 1463 2700K

CRI Ra>80
 IP Rating IP20
 Dimension ø37x100 mm
 Body Type C37
 Dimmable YES

480
Lumens

180°

E14

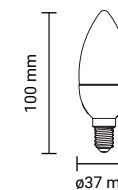



**LED Candle C37
8W E14**

Watts	8W	CRI	Ra>80
Input Voltage	AC : 175-265V	IP Rating	IP20
Flux	710lm	Dimension	ø37x112 mm
Beam Angle	180°	Body Type	C37
Socket	E14	Dimmable	NO

SKU: 1428 6000K SKU: 1429 4500K SKU: 1430 2700K



**LED Candle C37
5.5W E14**

Watts	5.5W	CRI	Ra>80
Input Voltage	AC : 175-265V	IP Rating	IP20
Flux	450lm	Dimension	ø37x125 mm
Beam Angle	180°	Body Type	C37
Socket	E14	Dimmable	NO

SKU: 1435 6000K SKU: 1436 4500K SKU: 1437 2700K

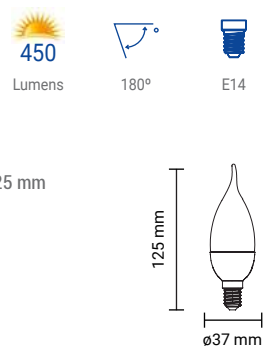

**LED Bulb P45
5.5W E14**

Watts	5.5W	CRI	Ra>80
Input Voltage	AC : 220-240V	IP Rating	IP20
Flux	450lm	Dimension	ø45x78 mm
Beam Angle	240°	Body Type	P45
Socket	E14	Dimmable	NO

SKU: 1401 6000K SKU: 1402 4500K SKU: 1403 2700K



**LED Bulb P45
8W E14**

Watts	8W	CRI	Ra>80
Input Voltage	AC : 220-240V	IP Rating	IP20
Flux	710lm	Dimension	ø45x78 mm
Beam Angle	240°	Body Type	P45
Socket	E14	Dimmable	NO

SKU: 1404 6000K SKU: 1405 4500K SKU: 1406 2700K



**LED Bulb P45
8.5W E14**

Watts	8.5W	CRI	Ra>80
Input Voltage	AC : 175-265V	IP Rating	IP20
Flux	800lm	Dimension	ø45x78 mm
Beam Angle	240°	Body Type	P45
Socket	E14	Dimmable	NO

SKU: 1493 6000K SKU: 1494 4500K SKU: 1495 2700K

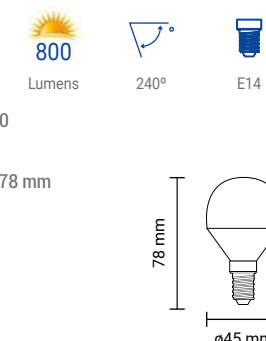

**LED Bulb R50
6W E14**

Watts	6W	CRI	Ra>80
Input Voltage	AC : 175-265V	IP Rating	IP20
Flux	450lm	Dimension	ø50x85 mm
Beam Angle	200°	Body Type	R50
Socket	E14	Dimmable	NO

SKU: 1438 6000K SKU: 1439 4500K SKU: 1440 2700K

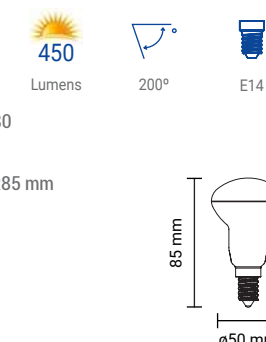



**LED Bulb A60 High Lumen
9W B22**

Watts 9W
 Input Voltage AC : 220-240V
 Flux 820lm
 Beam Angle 270°
 Socket B22

SKU: 1918 6000K
 SKU: 1919 4500K
 SKU: 1920 2700K

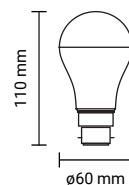
CRI Ra>80
 IP Rating IP20
 Dimension ϕ 60x110 mm
 Body Type A60
 Dimmable NO

**LED Bulb A60
10W B22**

Watts 10W
 Input Voltage AC : 220-240V
 Flux 800lm
 Beam Angle 270°
 Socket B22

SKU: 1910
 2700K

CRI Ra>80
 IP Rating IP20
 Dimension ϕ 60x110 mm
 Body Type A60
 Dimmable YES

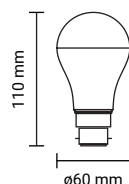
**LED Bulb A60 High Lumen
11W B22**

Watts 11W
 Input Voltage AC : 220-240V
 Flux 1055lm
 Beam Angle 270°
 Socket B22

SKU: 1921 6000K
 SKU: 1922 4500K
 SKU: 1923 2700K

CRI Ra>80
 IP Rating IP20
 Dimension ϕ 60x110 mm
 Body Type A60
 Dimmable NO

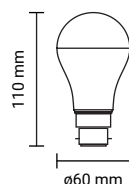
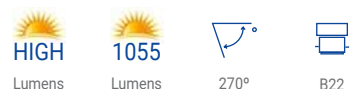
**LED Bulb A65
12W B22**

Watts 12W
 Input Voltage AC : 220-240V
 Flux 960lm
 Beam Angle 270°
 Socket B22

SKU: 1914
 2700K

CRI Ra>80
 IP Rating IP20
 Dimension ϕ 65x110 mm
 Body Type A65
 Dimmable YES

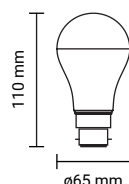
**LED Bulb A65
15W B22**

Watts 15W
 Input Voltage AC : 220-240V
 Flux 1200lm
 Beam Angle 270°
 Socket B22

SKU: 1915 6000K
 SKU: 1916 4500K
 SKU: 1917 2700K

CRI Ra>80
 IP Rating IP20
 Dimension ϕ 65x110 mm
 Body Type A65
 Dimmable NO

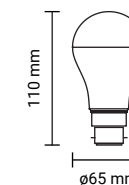
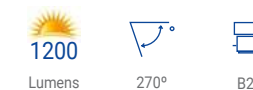
**LED Candle C37
6W B22**

Watts 6W
 Input Voltage AC : 220-240V
 Flux 480lm
 Beam Angle 180°
 Socket B22

SKU: 1950 6000K
 SKU: 1951 4500K
 SKU: 1952 2700K

CRI Ra>80
 IP Rating IP20
 Dimension ϕ 37x90 mm
 Body Type C37
 Dimmable NO

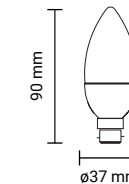
**LED Candle C37
6W B22**

Watts 6W
 Input Voltage AC : 220-240V
 Flux 480lm
 Beam Angle 180°
 Socket B22

SKU: 1953
 2700K

CRI Ra>80
 IP Rating IP20
 Dimension ϕ 37x90 mm
 Body Type C37
 Dimmable YES

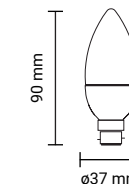
**LED Candle C37
6W B15**

Watts 6W
 Input Voltage AC : 220-240V
 Flux 480lm
 Beam Angle 180°
 Socket B15

SKU: 1954 6000K
 SKU: 1955 4500K
 SKU: 1956 2700K

CRI Ra>80
 IP Rating IP20
 Dimension ϕ 37x90 mm
 Body Type C37
 Dimmable NO

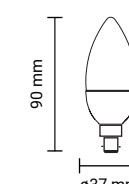
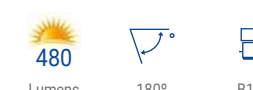



5 PCS
BLISTER



LED Spotlight G4
2W SMD

Watts 2W
Input Voltage AC;DC 12V
Flux 170lm
Beam Angle 360°
Socket G4

SKU: 1615 6000K
SKU: 1616 4500K
SKU: 1617 2700K

CRI Ra>80
IP Rating IP20
Dimension ø10x30 mm
Material Plastic
Dimmable NO

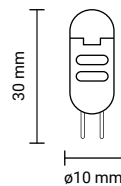

5 PCS
BLISTER



LED Spotlight G9
3.5W SMD

Watts 3.5W
Input Voltage AC:220-240V
Flux 400lm
Beam Angle 360°
Socket G9

SKU: 1651 6000K
SKU: 1652 4500K
SKU: 1653 2700K

CRI Ra>80
IP Rating IP20
Dimension ø16x50 mm
Material Ceramic
Dimmable NO

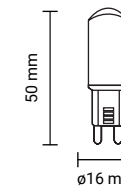

LED Spotlight G4/MR11
3W SMD

Watts 3W
Input Voltage AC;DC 12V
Flux 210lm
Beam Angle 38°
Socket G4

SKU: 1066 6000K
SKU: 1067 4500K
SKU: 1068 2700K

CRI Ra>80
IP Rating IP20
Dimension ø35x45 mm
Material Plastic
Dimmable NO

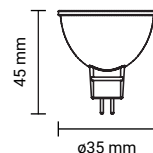

5 PCS
BLISTER



LED Spotlight G9
4W SMD

Watts 4W
Input Voltage AC:220-240V
Flux 400lm
Beam Angle 360°
Socket G9

SKU: 1654 6000K
SKU: 1655 4500K
SKU: 1656 2700K

CRI Ra>80
IP Rating IP20
Dimension ø16x50 mm
Material Ceramic
Dimmable YES

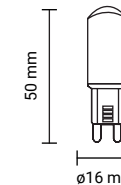

5 PCS
BLISTER



LED Spotlight G9
3W SMD

Watts 3W
Input Voltage AC:170-265V
Flux 220lm
Beam Angle 360°
Socket G9

SKU: 1638 6000K
SKU: 1639 4500K
SKU: 1640 2700K

CRI Ra>80
IP Rating IP20
Dimension ø16x48 mm
Material Plastic
Dimmable NO

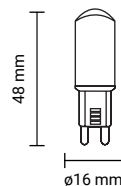

EPISTAR
Chips



LED Spotlight G5.3
15W AR11

Watts 15W
Input Voltage AC ; DC 12V
Flux 1050lm
Beam Angle 30°
Socket G5.3

SKU: 1517 4500K
SKU: 1516 2700K

CRI Ra>80
IP Rating IP20
Dimension ø111x58 mm
Material Plastic
Dimmable NO

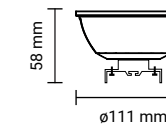

5 PCS
BLISTER



LED Spotlight G9
6W SMD

Watts 6W
Input Voltage AC:170-265V
Flux 550lm
Beam Angle 360°
Socket G9

SKU: 1644 6000K
SKU: 1645 4500K
SKU: 1646 2700K

CRI Ra>80
IP Rating IP20
Dimension ø18x64 mm
Material Plastic
Dimmable YES

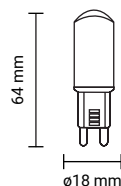

EPISTAR
Chips



LED Spotlight G5.3
15W AR11

Watts 15W
Input Voltage AC ; DC 12V
Flux 1050lm
Beam Angle 120°
Socket G5.3

SKU: 1519 4500K
SKU: 1518 2700K

CRI Ra>80
IP Rating IP20
Dimension ø111x58 mm
Material Plastic
Dimmable NO

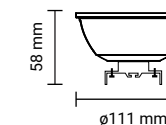
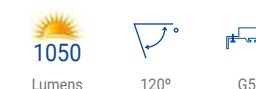

**LED Spotlight GU10
9W AR111**

Watts 9W
 Input Voltage AC: 170-265V
 Flux 820lm
 Beam Angle 120°
 Socket GU10

SKU: 1531 SKU: 1532
 4500K 2700K

CRI Ra>80
 IP Rating IP20
 Dimension ϕ 111x58 mm
 Material Plastic
 Dimmable NO

820
 Lumens

120°

GU10

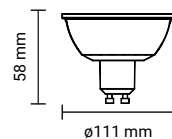
**LED Spotlight GU10
15W AR111**

Watts 15W
 Input Voltage AC: 170-265V
 Flux 1200lm
 Beam Angle 30°
 Socket GU10

SKU: 1533 SKU: 1534
 4500K 2700K

CRI Ra>80
 IP Rating IP20
 Dimension ϕ 111x58 mm
 Material Aluminium
 Dimmable NO

1200
 Lumens

30°

GU10

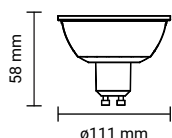
**LED Spotlight GU10
15W AR111**

Watts 15W
 Input Voltage AC: 170-265V
 Flux 1100lm
 Beam Angle 30°
 Socket GU10

SKU: 1535 SKU: 1536
 4500K 2700K

CRI Ra>80
 IP Rating IP20
 Dimension ϕ 111x58 mm
 Material Aluminium
 Dimmable YES

1100
 Lumens

Dimmable

GU10

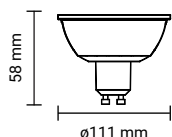
**LED Spotlight GX53
7W Recessed**

Watts 7W
 Input Voltage AC:220-240V
 Flux 560lm
 Beam Angle 180°
 Socket GX53

SKU: 1541 SKU:1542 SKU: 1543
 6000K 4500K 2700K

CRI Ra>80
 IP Rating IP20
 Dimension ϕ 74x25 mm
 Material Plastic
 Dimmable NO

560
 Lumens

180°

GX53

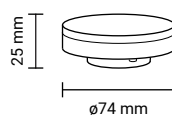
**LED Spotlight GU5.3/MR16
5W SMD**

Watts 5W
 Input Voltage DC : 12V
 Flux 400lm
 Beam Angle 110°
 Socket GU5.3

SKU: 1191 SKU:1192 SKU: 1193
 6000K 4500K 2700K

CRI Ra>80
 IP Rating IP20
 Dimension ϕ 50x47 mm
 Material Plastic
 Dimmable NO

400
 Lumens

110°

GU5.3

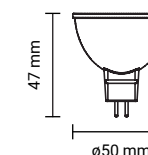
**LED Spotlight GU5.3/MR16
7W SMD**

Watts 7W
 Input Voltage DC : 12V
 Flux 600lm
 Beam Angle 110°
 Socket GU5.3

SKU: 1194 SKU:1195 SKU: 1196
 6000K 4500K 2700K

CRI Ra>80
 IP Rating IP20
 Dimension ϕ 50x47 mm
 Material Plastic
 Dimmable NO

600
 Lumens

110°

GU5.3

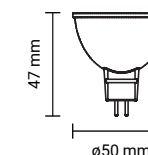
**LED Spotlight GU5.3/MR16
4W COB**

Watts 4W
 Input Voltage AC;DC 12V
 Flux 320lm
 Beam Angle 50°
 Socket GU5.3

SKU: 1163 SKU:1167 SKU: 1164
 6000K 4500K 2700K

CRI Ra>80
 IP Rating IP20
 Dimension ϕ 50x55 mm
 Material Plastic
 Dimmable NO

320
 Lumens

50°

GU5.3

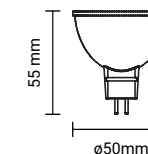
**LED Spotlight GU5.3/MR16
6W COB**

Watts 6W
 Input Voltage AC;DC 12V
 Flux 400lm
 Beam Angle 50°
 Socket GU5.3

SKU: 1168 SKU:1169 SKU: 1170
 6000K 4500K 2700K

CRI Ra>80
 IP Rating IP20
 Dimension ϕ 50x55 mm
 Material Plastic
 Dimmable NO

400
 Lumens

50°

GU5.3

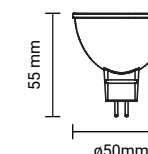

**LED Spotlight GU10
4W COB**

Watts	4W	CRI	Ra>80
Input Voltage	AC : 220-240V	IP Rating	IP20
Flux	320lm	Dimension	ø50x55 mm
Beam Angle	50°	Body Color	White
Socket	GU10	Dimmable	NO

SKU: 1957 SKU:1958 SKU: 1959
 6000K 4500K 2700K

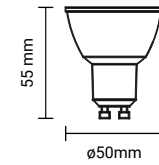
**LED Spotlight GU10
4W COB**

Watts	4W	CRI	Ra>80
Input Voltage	AC : 220-240V	IP Rating	IP20
Flux	320lm	Dimension	ø50x60 mm
Beam Angle	50°	Body Color	Gray
Socket	GU10	Dimmable	NO

SKU: 1263 SKU:1264 SKU: 1265
 6000K 4500K 2700K

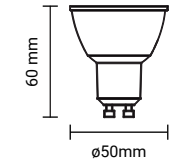
**LED Spotlight GU10
6W COB**

Watts	6W	CRI	Ra>80
Input Voltage	AC : 220-240V	IP Rating	IP20
Flux	480lm	Dimension	ø50x55 mm
Beam Angle	50°	Body Color	White
Socket	GU10	Dimmable	NO

SKU: 1960 SKU:1961 SKU: 1962
 6000K 4500K 2700K

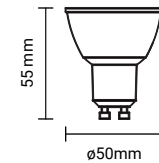
**LED Spotlight GU10
4W COB**

Watts	4W	CRI	Ra>80
Input Voltage	AC : 220-240V	IP Rating	IP20
Flux	320lm	Dimension	ø50x60 mm
Beam Angle	50°	Body Color	Gray
Socket	GU10	Dimmable	YES

SKU: 1266 SKU:1267 SKU: 1268
 6000K 4500K 2700K

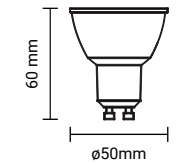
**LED Spotlight GU10
6W COB**

Watts	6W	CRI	Ra>80
Input Voltage	AC : 220-240V	IP Rating	IP20
Flux	480lm	Dimension	ø50x55 mm
Beam Angle	50°	Body Color	White
Socket	GU10	Dimmable	YES

SKU: 1963 SKU:1964 SKU: 1965
 6000K 4500K 2700K

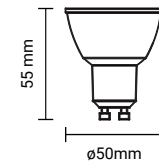
**LED Spotlight GU10
6W COB**

Watts	6W	CRI	Ra>80
Input Voltage	AC : 220-240V	IP Rating	IP20
Flux	480lm	Dimension	ø50x60 mm
Beam Angle	50°	Body Color	Gray
Socket	GU10	Dimmable	NO

SKU: 1269 SKU:1270 SKU: 1271
 6000K 4500K 2700K

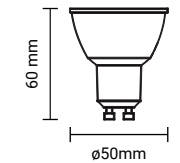
**LED Spotlight GU10
6W COB**

Watts	6W	CRI	Ra>80
Input Voltage	AC : 220-240V	IP Rating	IP20
Flux	480lm	Dimension	ø50x60 mm
Beam Angle	50°	Body Color	Gray
Socket	GU10	Dimmable	YES

SKU: 1272 SKU:1273 SKU: 1274
 6000K 4500K 2700K

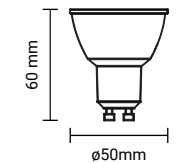



LED Spotlight GU10
4.5W SMD

Watts 4.5W
Input Voltage AC : 220-240V
Flux 320lm
Beam Angle 110°
Socket GU10

CRI Ra>80
IP Rating IP20
Dimension ø50x57 mm
Material Plastic
Dimmable NO

SKU: 1901 6000K
SKU: 1902 4500K
SKU: 1903 2700K

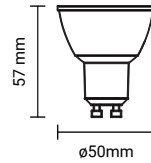

LED Spotlight GU10
7W SMD

Watts 7W
Input Voltage AC : 175-265V
Flux 600lm
Beam Angle 110°
Socket GU10

CRI Ra>80
IP Rating IP20
Dimension ø50x57 mm
Material Plastic
Dimmable NO

SKU: 1932 6000K
SKU: 1933 4500K
SKU: 1934 2700K

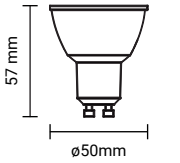

LED Spotlight GU10
7W SMD

Watts 7W
Input Voltage AC : 175-265V
Flux 560lm
Beam Angle 38°
Socket GU10

CRI Ra>80
IP Rating IP20
Dimension ø50x57 mm
Material Plastic
Dimmable NO

SKU: 1938 6000K
SKU: 1939 4500K
SKU: 1940 2700K

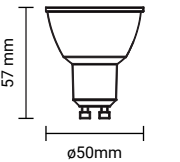

LED Spotlight GU10
7W SMD

Watts 7W
Input Voltage AC : 175-265V
Flux 560lm
Beam Angle 38°
Socket GU10

CRI Ra>80
IP Rating IP20
Dimension ø50x57 mm
Material Plastic
Dimmable YES

SKU: 1943 4500K

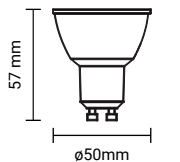

LED Spotlight GU10
5W SMD

Watts 5W
Input Voltage AC : 175-265V
Flux 400lm
Beam Angle 38°
Socket GU10

CRI Ra>80
IP Rating IP20
Dimension ø50x57 mm
Material Plastic
Dimmable NO

SKU: 1935 6000K
SKU: 1936 4500K
SKU: 1937 2700K

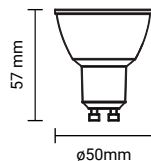

LED Spotlight GU10
6.5W SMD

Watts 6.5W
Input Voltage AC : 220-240V
Flux 550lm
Beam Angle 110°
Socket GU10

CRI Ra>80
IP Rating IP20
Dimension ø50x57 mm
Material Plastic
Dimmable NO

SKU: 1904 6000K
SKU: 1905 4500K
SKU: 1906 2700K

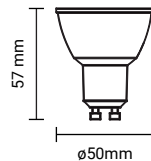



LED Spotlight GU10
7W SMD

Watts 7W
Input Voltage AC : 175-265V
Flux 500lm
Beam Angle 110°
Socket GU10

SKU: 1945 6000K
SKU:1946 4500K
SKU: 1947 2700K

CRI Ra>80
IP Rating IP20
Dimension ø50x57 mm
Material Plastic
Dimmable YES

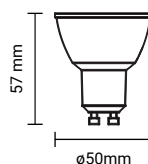

LED Spotlight GU10
9.5W SMD

Watts 9.5W
Input Voltage AC : 220-240V
Flux 880lm
Beam Angle 110°
Socket GU10

SKU: 1907 6000K
SKU:1908 4500K
SKU: 1909 2700K

CRI Ra>80
IP Rating IP20
Dimension ø50x57 mm
Material Plastic
Dimmable NO

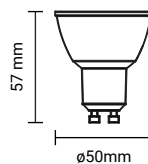

LED Spotlight GU10
10W SMD

Watts 10W
Input Voltage AC : 175-265V
Flux 880lm
Beam Angle 110°
Socket GU10

SKU: 1970 6000K
SKU:1971 4500K
SKU: 1972 2700K

CRI Ra>80
IP Rating IP20
Dimension ø50x57 mm
Material Plastic
Dimmable NO

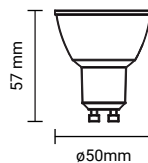

PORTABLE LED SOLAR BULB
Solar Panel Power: 6V 2.3W

Voltage 6V
Flux 650lm
Beam Angle 360°
Battery 3.2V 10Ah

CRI Ra>80
IP Rating IP20
Body Color White
Dimension ø110x195 mm

SKU: 229
6000K

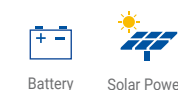



LED Bulbs Premium Line

5 Years

Warranty



5 Years
Warranty

**LED Bulb G95
12W E27**

1055
Lumens

270°

E27

Watts 12W
Input Voltage AC : 175-265V
Flux 1055lm
Beam Angle 270°
Socket E27

CRI Ra>80
IP Rating IP20
Dimension ø95x127 mm
Body Type G95
Dimmable NO

SKU: 1742 SKU:1743 SKU: 1744
6000K 4500K 2700K

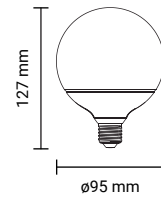

5 Years
Warranty

**LED Bulb G120
15W E27**

1320
Lumens

270°

E27

Watts 15W
Input Voltage AC : 175-265V
Flux 1320lm
Beam Angle 270°
Socket E27

CRI Ra>80
IP Rating IP20
Dimension ø120x155 mm
Body Type G120
Dimmable NO

SKU: 1745 SKU:1746 SKU: 1747
6000K 4500K 2700K

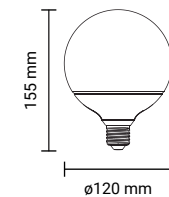

**LED Bulb A60
10W E27**

950
Lumens

5 Years
Warranty

E27

Watts 10W
Input Voltage AC : 175-265V
Flux 950lm
Beam Angle 270°
Socket E27

CRI Ra>80
IP Rating IP20
Dimension ø60x109 mm
Body Type A60
Dimmable NO

SKU: 1718 SKU:1719 SKU: 1720
6000K 4500K 2700K

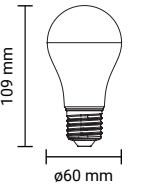

**LED Bulb A60
12W E27**

1155
Lumens

5 Years
Warranty

E27

Watts 12W
Input Voltage AC : 175-265V
Flux 1155lm
Beam Angle 270°
Socket E27

CRI Ra>80
IP Rating IP20
Dimension ø60x112 mm
Body Type A60
Dimmable NO

SKU: 1721 SKU:1722 SKU: 1723
6000K 4500K 2700K

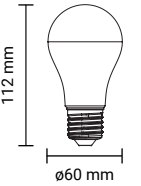

**LED Bulb A60
15W E27**

1500
Lumens

5 Years
Warranty

E27

Watts 15W
Input Voltage AC : 175-265V
Flux 1500lm
Beam Angle 270°
Socket E27

CRI Ra>80
IP Rating IP20
Dimension ø60x127 mm
Body Type A60
Dimmable NO

SKU: 1724 SKU:1725 SKU: 1726
6000K 4500K 2700K

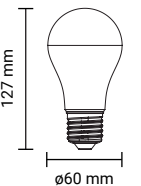

**LED Bulb A70
18W E27**

1880
Lumens

5 Years
Warranty

E27

Watts 18W
Input Voltage AC : 175-265V
Flux 1880lm
Beam Angle 270°
Socket E27

CRI Ra>80
IP Rating IP20
Dimension ø70x145 mm
Body Type A70
Dimmable NO

SKU: 1748 SKU:1749 SKU: 1750
6000K 4500K 2700K

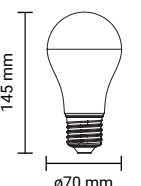



5 Years Warranty

LED Spotlight GU5.3/MR16
5W SMD

Watts 5W
Input Voltage DC : 12V
Flux 320lm
Beam Angle 110°
Socket GU5.3

CRI Ra>80
IP Rating IP20
Dimension ø50x47 mm
Material Plastic
Dimmable NO

SKU: 1761 6000K
SKU: 1762 4500K
SKU: 1763 2700K

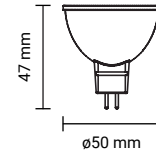

5 Years Warranty

LED Spotlight GU5.3/MR16
7W SMD

Watts 7W
Input Voltage DC : 12V
Flux 500lm
Beam Angle 110°
Socket GU5.3

CRI Ra>80
IP Rating IP20
Dimension ø50x47 mm
Material Plastic
Dimmable NO

SKU: 1764 6000K
SKU: 1765 4500K
SKU: 1766 2700K

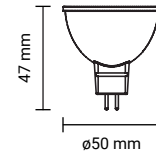

5 Years Warranty

LED Spotlight GU10
5W SMD

Watts 5W
Input Voltage AC : 175-265V
Flux 320lm
Beam Angle 110°
Socket GU10

CRI Ra>80
IP Rating IP20
Dimension ø50x57 mm
Material Plastic
Dimmable NO

SKU: 1767 6000K
SKU: 1768 4500K
SKU: 1769 2700K

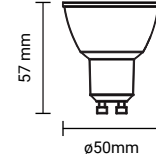

5 Years Warranty

LED Spotlight GU10
7W SMD

Watts 7W
Input Voltage AC : 175-265V
Flux 600lm
Beam Angle 110°
Socket GU10

CRI Ra>80
IP Rating IP20
Dimension ø50x57 mm
Material Plastic
Dimmable NO

SKU: 1772 6000K
SKU: 1770 4500K
SKU: 1773 2700K

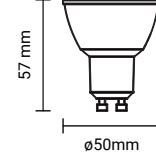

SKU: 5081 WHITE BODY
Dimension 180x180x42 mm



SKU: 5083 WHITE BODY
Dimension 330x180x42 mm



SKU: 5085 WHITE BODY
Dimension 480x180x42 mm



Accessories
AR111 Fitting Adjustable

2 PCS BOX



SKU: 5082 SILVER BODY
Dimension 180x180x42 mm



SKU: 5084 SILVER BODY
Dimension 330x180x42 mm



SKU: 5086 SILVER BODY
Dimension 480x180x42 mm



Accessories
AR111 Fitting Adjustable

2 PCS BOX



SKU: 5070 WHITE BODY
Dimension ø82x30 mm

SKU: 5071 INOX BODY
Dimension ø82x30 mm

SKU: 5072 CHROME BODY
Dimension ø82x30 mm

Accessories
GU10,MR16 Fitting



SKU: 5170 WHITE BODY Aluminium
Dimension ø83x29 mm

SKU: 5171 INOX BODY Aluminium
Dimension ø83x29 mm

SKU: 5172 CHROME BODY Aluminium
Dimension ø83x29 mm

SKU: 5097 WHITE BODY
Dimension ø83x29 mm

SKU: 5098 INOX BODY
Dimension ø83x29 mm

SKU: 5099 CHROME BODY
Dimension ø83x29 mm

Accessories
GU10,MR16 Fitting Adjustable



SKU: 5073 WHITE BODY
Dimension 83x83x30 mm

SKU: 5074 INOX BODY
Dimension 83x83x30 mm

SKU: 5075 CHROME BODY
Dimension 83x83x30 mm

Accessories
GU10,MR16 Fitting



SKU: 5076 WHITE BODY
Dimension ø83x29 mm

SKU: 5077 INOX BODY
Dimension ø83x29 mm

SKU: 5078 CHROME BODY
Dimension ø83x29 mm

Accessories
GU10,MR16 Fitting Adjustable



**Spotlight Fixture - Waterproof
GU10 Fitting**

Product code	OT1-A2	IP Rating	IP65
Socket	GU10	Dimension	Φ80x54 ; 83x83x54 mm
Input Voltage	AC : 220-240V	Body Colors	White ; Satin Nickel
Material	Aluminium	Max Power	35W

SKU: 2009 White Body - Round

SKU: 2011 White Body - Square

**Spotlight Fixture - Aluminium
GU10 Fitting**

Product code	OT1-A2	IP Rating	IP20
Socket	GU10	Dimension	φ79x32 mm
Input Voltage	AC : 220-240V	Body Colors	White
Material	Aluminium+PC	Max Power	35W

SKU: 2048 Black Reflector

SKU: 2047 White Reflector

SKU: 2049 Rose Gold Reflector

**Spotlight Fixture - Waterproof
GU10 Fitting**

Product code	OT1-A2	IP Rating	IP65
Socket	GU10	Dimension	Φ80x54 ; 83x83x54 mm
Input Voltage	AC : 220-240V	Body Colors	White ; Satin Nickel
Material	Aluminium	Max Power	35W

SKU: 2010 Satin Nickel - Round

SKU: 2012 Satin Nickel - Square

**Spotlight Fixture - Plastic
GU10 Fitting**

Product code	OT1-A2	IP Rating	IP20
Socket	GU10	Dimension	102x102x42 mm
Input Voltage	AC : 220-240V	Body Colors	White,Black,White-Black
Material	Plastic	Max Power	35W

SKU: 2050 White Body

SKU: 2051 Black Body

SKU: 2052 White-Black Body

**Spotlight Fixture - Aluminium
2xGU10 Fitting Adjustable**

Product code	OT1-A2	IP Rating	IP20
Socket	2xGU10	Dimension	80x160x85
Input Voltage	AC : 220-240V	Body Colors	White-Black
Material	Aluminium	Max Power	35W

SKU: 2080 White- 2xGU10

SKU: 2081 Black- 2XGu10



ø90mm



90x90mm

**Spotlight Fixture - Aluminium
GU10 Fitting Adjustable**

Product code	OT1-A2	IP Rating	IP20
Socket	GU10	Dimension	ø100x38 mm ;100x100x38mm
Input Voltage	AC : 220-240V	Body Colors	White-Black
Material	Aluminium	Max Power	35W

SKU: 2013 White/Black- Round

SKU: 2014 White/Black- Square

**Spotlight Fixture - Aluminium
GU10 Fitting**

Product code	OT1-A2	IP Rating	IP20
Socket	GU10	Dimension	φ120x80mm;120x120x80mm
Input Voltage	AC : 220-240V	Body Colors	Black
Material	Aluminium	Max Power	35W

SKU: 2082 Black-Round

SKU: 2083 Black-Square



175x90mm



260x90mm

**Spotlight Fixture - Aluminium
GU10 Fitting Adjustable**

Product code	OT1-A2	IP Rating	IP20
Socket	GU10	Dimension	185x100x38mm , 270x100x38 mm
Input Voltage	AC : 220-240V	Body Colors	White-Black
Material	Aluminium	Max Power	35W

SKU: 2015 2xGU10 Holder

SKU: 2016 3xGU10 Holder

**Spotlight Fixture - Round
GU10 Fitting**

Product code	OT1-A2	IP Rating	IP20
Socket	GU10	Dimension	φ80x42 mm
Input Voltage	AC : 220-240V	Body Colors	White ; Black
Material	Aluminium+PC	Max Power	35W

SKU: 2031 White
SKU: 2032 Black

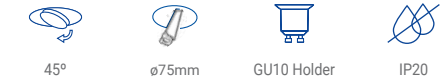
**Spotlight Fixture - Round
GU10 Fitting**

Product code	OT1-A2	IP Rating	IP20
Socket	GU10	Dimension	φ80x42 mm
Input Voltage	AC : 220-240V	Body Colors	White ; Black
Material	Aluminium+PC	Max Power	35W

SKU: 2035 Round
SKU: 2036 Black

**Spotlight Fixture - Round
GU10 Fitting**

Product code	OT1-A2	IP Rating	IP20
Socket	GU10	Dimension	φ80x42 mm
Input Voltage	AC : 220-240V	Body Colors	White ; Black
Material	Aluminium+PC	Max Power	35W

SKU: 2033 White
SKU: 2034 Black

**Spotlight Fixture - Round
GU10 Fitting**

Product code	OT1-A2	IP Rating	IP20
Socket	GU10	Dimension	φ80x42 mm
Input Voltage	AC : 220-240V	Body Colors	White ; Black
Material	Aluminium+PC	Max Power	35W

SKU: 2037 White
SKU: 2038 Black



Spotlight Fixture
GU10 Fitting



Product code	OT1-A2	IP Rating	IP20
Socket	GU10	Dimension	75x75x140 mm
Input Voltage	AC : 220-240V	Body Colors	White
Material	Aluminium	Max Power	35W

- SKU: 2039 Black Reflector
- SKU: 2040 White Reflector
- SKU: 2041 Rose Gold Reflector



Spotlight Fixture -Plastic
GU10 Fitting Adjustable



Product code	OT1-A2	IP Rating	IP20
Socket	GU10	Dimension	Φ80x125 mm
Input Voltage	AC : 220-240V	Body Colors	White ; Black
Material	Plastic	Max Power	10W

- SKU: 2001 White Body
- SKU: 2002 Black Body
- SKU: 2005 White Body
- SKU: 2006 Black Body



Spotlight Fixture
GU10 Fitting



Product code	OT1-A2	IP Rating	IP20
Socket	GU10	Dimension	Φ80x140 mm
Input Voltage	AC : 220-240V	Body Colors	White
Material	Aluminium	Max Power	35W

- SKU: 2042 Black Reflector
- SKU: 2043 White Reflector
- SKU: 2044 Rose Gold Reflector



Spotlight Fixture -Plastic
GU10 Fitting Adjustable



Product code	OT1-A2	IP Rating	IP20
Socket	GU10	Dimension	85x85x130 mm
Input Voltage	AC : 220-240V	Body Colors	White ; Black
Material	Plastic	Max Power	10W

- SKU: 2003 White Body
- SKU: 2004 Black Body
- SKU: 2007 White Body
- SKU: 2008 Black Body



Spotlight Fixture - Aluminium
GU10 Fitting Adjustable



Product code	OT1-A2	IP Rating	IP20
Socket	GU10	Dimension	φ80x42 mm
Input Voltage	AC : 220-240V	Body Colors	White ; Black
Material	Aluminium+PC	Max Power	35W

SKU: 2027 White Body
 SKU: 2028 Black Body



Tracklight Fixture -Aluminium
**GU10 Fitting Adjustable
 For 3-Phase Track**



Product code	OT1-A2	IP Rating	IP20
Socket	GU10	Dimension	φ55x82 mm
Input Voltage	AC : 220-240V	Body Colors	White ; Black
Material	Aluminium	Max Power	35W

SKU: 2017 White Body
 SKU: 2018 Black Body



Spotlight Fixture - Aluminium
GU10 Fitting



Product code	OT1-A2	IP Rating	IP20
Socket	GU10	Dimension	φ60x100 mm
Input Voltage	AC : 220-240V	Body Colors	White ; Black
Material	Aluminium+PC	Max Power	35W

SKU: 2029 White Body
 SKU: 2030 Black Body



Tracklight Fixture -Plastic
**GU10 Fitting Adjustable
 For Single-Phase Track**



Product code	OT1-A2	IP Rating	IP20
Socket	GU10	Dimension	φ59x94x114 mm
Input Voltage	AC : 220-240V	Body Colors	White ; Black
Material	Plastic	Max Power	10W

SKU: 2019 White Body
 SKU: 2020 Black Body

**Spotlight Fixture - Plastic
GU10 Fitting**

90°



GU10 Holder



IP20

Product code	OT1-A2	IP Rating	IP20
Socket	GU10	Dimension	φ120x145 mm
Input Voltage	AC : 220-240V	Body Colors	White ; Black
Material	Plastic	Max Power	10W

SKU: 2021 White
SKU: 2022 Black

**Spotlight Fixture - Plastic
GU10 Fitting**

90°



GU10 Holder



IP20

Product code	OT1-A2	IP Rating	IP20
Socket	GU10	Dimension	φ120x145 mm
Input Voltage	AC : 220-240V	Body Colors	White ; Black
Material	Plastic	Max Power	10W Each

SKU: 2025 White
SKU: 2026 Black



75x75mm



φ85mm

**Spotlight Fixture - Plastic
GU10 Fitting**

90°



GU10 Holder



IP20

Product code	OT1-A2	IP Rating	IP20
Socket	GU10	Dimension	φ120x145 mm
Input Voltage	AC : 220-240V	Body Colors	White ; Black
Material	Plastic	Max Power	10W Each

SKU: 2023 Round
SKU: 2024 Square

**Spotlight Fixture - Recessed
GU10 Fitting**

GU10 Holder



IP20

Product code	OT1-A2	IP Rating	IP20
Socket	GU10	Dimension	75x75x55mm ; φ85x50mm
Input Voltage	AC : 220-240V	Body Colors	White - Black Reflektor
Material	Aluminium+PC	Max Power	35W

SKU: 2045 Square
SKU: 2046 Round



Ceiling Fixture Trimless Recessed

GU10 Fitting
Gypsum + ALU

Product code	OT1-A2	IP Rating	IP20
Socket	GU10	Dimension	φ100x27mm ; 100x100x27mm
Input Voltage	AC : 220-240V	Body Colors	White
Material	Gypsum+Alu	Max Power	35W

SKU: 2060 Round
 SKU: 2061 Square

Ceiling Fixture Trimless Recessed

GU10 Fitting
Gypsum + ALU

Product code	OT1-A2	IP Rating	IP20
Socket	GU10	Dimension	120x120x60mm ; 215x118x58mm
Input Voltage	AC : 220-240V	Body Colors	White
Material	Gypsum+Alu	Max Power	35W

SKU: 2064 Square
 SKU: 2065 Rectangle



Ceiling Fixture Trimless Recessed

GU10 Fitting
Gypsum + ALU

Product code	OT1-A2	IP Rating	IP20
Socket	GU10	Dimension	φ130x50mm ; 120x120x60mm
Input Voltage	AC : 220-240V	Body Colors	White
Material	Gypsum+Alu	Max Power	35W

SKU: 2062 Round
 SKU: 2063 Square

Ceiling Fixture Trimless Recessed

GU10 Fitting
Gypsum + ALU

Product code	OT1-A2	IP Rating	IP20
Socket	GU10	Dimension	120x120x60mm ; 215x118x58mm
Input Voltage	AC : 220-240V	Body Colors	White
Material	Gypsum+Alu	Max Power	35W

SKU: 2066 Round
 SKU: 2067 Square

Ceiling Fixture Trimless Recessed
GU10 Fitting
Gypsum + ALU

Product code	OT1-A2	IP Rating	IP20
Socket	GU10	Dimension	φ120x65mm
Input Voltage	AC : 220-240V	Body Colors	White
Material	Gypsum+Alu	Max Power	35W



SKU: 2068 Round-Frosted
 SKU: 2069 Round

Ceiling Fixture Surface Mounted
GU10 Fitting
Gypsum + ALU

Product code	OT1-A2	IP Rating	IP20
Socket	GU10	Dimension	70x70x70mm ; 70x70x170mm
Input Voltage	AC : 220-240V	Body Colors	White
Material	Gypsum+Alu	Max Power	35W



SKU: 2072 Square H70
 SKU: 2073 Square H170

Ceiling Fixture Surface Mounted
GU10 Fitting
Gypsum + ALU

Product code	OT1-A2	IP Rating	IP20
Socket	GU10	Dimension	φ70x70 mm ; φ70x170 mm
Input Voltage	AC : 220-240V	Body Colors	White
Material	Gypsum+Alu	Max Power	35W



SKU: 2070 Round H70mm
 SKU: 2071 Round H170mm

Ceiling Fixture Surface Mounted
GU10 Fitting
Gypsum + ALU

Product code	OT1-A2	IP Rating	IP20
Socket	GU10	Dimension	φ110x140mm ; 110x110x140mm
Input Voltage	AC : 220-240V	Body Colors	White
Material	Gypsum+Alu	Max Power	35W



SKU: 2074 Round
 SKU: 2075 Square

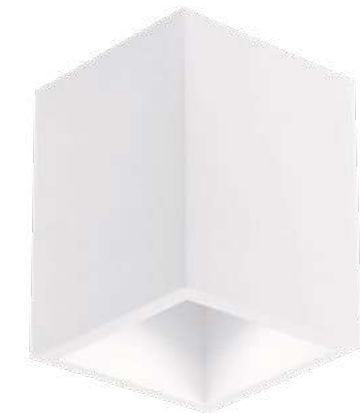

Spotlight Fixture - Single Head
GU10 Fitting

90°



GU10 Holder



IP20

Product code	OT1-A6	IP Rating	IP20
Socket	GU10	Dimension	60x108 mm
Input Voltage	AC : 220-240V	Body Colors	Black ; White
Material	Aluminium	Max Power	35W

SKU: 9072 Black
 SKU: 9076 White

Spotlight Fixture - Three Heads
GU10 Fitting

90°



GU10 Holder



IP20

Product code	OT1-A6	IP Rating	IP20
Socket	GU10x3	Dimension	540x60x180 mm
Input Voltage	AC : 220-240V	Body Colors	Black ; White
Material	Aluminium	Max Power	35W Each

SKU: 9074 Black GU10x3
 SKU: 9078 White GU10x3

Spotlight Fixture - Two Heads
GU10 Fitting

90°



GU10 Holder



IP20

Product code	OT1-A6	IP Rating	IP20
Socket	GU10x2	Dimension	300x60x180mm
Input Voltage	AC : 220-240V	Body Colors	Black ; White
Material	Aluminium	Max Power	35W Each

SKU: 9073 Black GU10x2
 SKU: 9077 White GU10x2

Spotlight Fixture - Four Heads
GU10 Fitting

90°



GU10 Holder



IP20

Product code	OT1-A6	IP Rating	IP20
Socket	GU10x4	Dimension	720x60x180 mm
Input Voltage	AC : 220-240V	Body Colors	Black ; White
Material	Aluminium	Max Power	35W Each

SKU: 9075 Black GU10x4
 SKU: 9079 White GU10x4

Hanging Fixture - H300mm
GU10 Fitting

Product code	OT1-A6	IP Rating	IP20
Socket	GU10	Dimension	60x300 mm
Input Voltage	AC : 220-240V	Body Colors	Black ; White
Material	Aluminium	Max Power	35W

SKU: 9050	Black - Inner range: Gold
SKU: 9051	Black - Inner range: Black
SKU: 9054	White - Inner range: Gold
SKU: 9055	White - Inner range: Black

Hanging Fixture - H500mm
GU10 Fitting

Product code	OT1-A6	IP Rating	IP20
Socket	GU10	Dimension	60x500 mm
Input Voltage	AC : 220-240V	Body Colors	Black ; White
Material	Aluminium	Max Power	35W

SKU: 9058	Black Body
SKU: 9059	White Body

Hanging Fixture - H500mm
GU10 Fitting

Product code	OT1-A6	IP Rating	IP20
Socket	GU10	Dimension	60x500 mm
Input Voltage	AC : 220-240V	Body Colors	Black ; White
Material	Aluminium	Max Power	35W

SKU: 9052	Black - Inner range: Gold
SKU: 9053	Black - Inner range: Black
SKU: 9056	White - Inner range: Gold
SKU: 9057	White - Inner range: Black

Hanging Fixture - H200mm
GU10 Fitting

Product code	OT1-A6	IP Rating	IP20
Socket	GU10	Dimension	60x200 mm
Input Voltage	AC : 220-240V	Body Colors	Black ; White
Material	Aluminium	Max Power	35W

SKU: 9060	Black Body
SKU: 9061	White Body



Hanging Fixture - H300mm
GU10 Fitting

Product code	OT1-A6	IP Rating	IP20
Socket	GU10	Dimension	55x300 mm
Input Voltage	AC : 220-240V	Body Colors	B/W/G/CG/C
Material	Aluminium	Max Power	35W



SKU: 9062	Black Body
SKU: 9063	White Body
SKU: 9064	Gold Body
SKU: 9065	Coffee Gold Body
SKU: 9066	Chrome Body

Hanging Fixture - H300mm
GU10 Fitting

Product code	OT1-A6	IP Rating	IP20
Socket	GU10	Dimension	55x300 mm
Input Voltage	AC : 220-240V	Body Colors	B/W/G/CG/C
Material	Aluminium	Max Power	35W



SKU: 9067	Black Body
SKU: 9068	White Body
SKU: 9069	Gold Body
SKU: 9070	Coffee Gold Body
SKU: 9071	Chrome Body



Hanging Fixture - H400mm
GU10 Fitting



Product code	OT1-A6	IP Rating	IP20
Socket	GU10	Dimension	60x400 mm
Input Voltage	AC : 220-240V	Body Colors	B/W/S/GR
Material	Aluminium	Max Power	35W

SKU: 9082	Black Body
SKU: 9083	White Body
SKU: 9080	Silver Body
SKU: 9081	Grape Red Body

Hanging Fixture - H400mm
E27 Fitting



Product code	OT1-A6	IP Rating	IP20
Socket	E27	Dimension	40x400 mm
Input Voltage	AC : 220-240V	Body Colors	B/W/CG/RG
Material	Aluminium	Max Power	35W

SKU: 9084	Black Body
SKU: 9085	White Body
SKU: 9086	Coffee Gold Body
SKU: 9087	Rose Gold Body



LED TUBES AND BATTEN LIGHTS

LED tubes are the perfect replacement for old fluorescent tubes. With variety of sizes, powers and colour temperatures they are suitable for every need – from home use to office or warehouses.

Features:

- Up to 80% power saving
- Standard sizes, fits already built lighting solutions
- Variety of colour temperatures
- Single or two side power
- Build-in starters
- Variety of covers – from nano-plastic to glass

Application:

- Indoor use – home, offices, shops
- Main lighting
- Suitable for tube fixtures



Switch



LED TUBE T5 - Plastic
Matt With Switch



3.4W
300
Lumens

Watts	3.4W	Beam Angle	120°
Input Voltage	AC : 220-240V	CRI	Ra>80
Flux	300lm	IP Rating	IP20

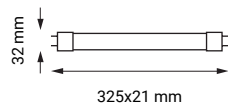

SKU: 5588 6000K
SKU: 5589 4000K
SKU: 5590 3000K

6.5W
600
Lumens

Watts	6.5W	Beam Angle	120°
Input Voltage	AC : 220-240V	CRI	Ra>80
Flux	600lm	IP Rating	IP20

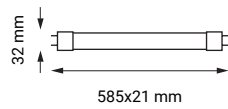

SKU: 5591 6000K
SKU: 5592 4000K
SKU: 5593 3000K

9.6W
900
Lumens

Watts	9.6W	Beam Angle	120°
Input Voltage	AC : 220-240V	CRI	Ra>80
Flux	900lm	IP Rating	IP20

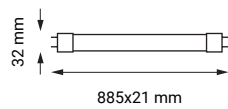

SKU: 5594 6000K
SKU: 5595 4000K
SKU: 5596 3000K

13W
1200
Lumens

Watts	13W	Beam Angle	120°
Input Voltage	AC : 220-240V	CRI	Ra>80
Flux	1200lm	IP Rating	IP20

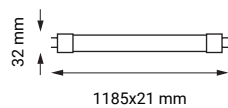

SKU: 5597 6000K
SKU: 5598 4000K
SKU: 5599 3000K



T5 DOUBLE INPUT CABLE
Not Included
Length: 30cm / 50cm / 100cm



LED TUBE T5 - Plastic
Matt



3.4W
300
Lumens

Watts	3.4W	Beam Angle	120°
Input Voltage	AC : 220-240V	CRI	Ra>80
Flux	300lm	IP Rating	IP20

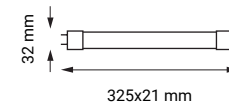

SKU: 5501 6000K
SKU: 5502 4000K
SKU: 5503 3000K

6.5W
600
Lumens

Watts	6.5W	Beam Angle	120°
Input Voltage	AC : 220-240V	CRI	Ra>80
Flux	600lm	IP Rating	IP20

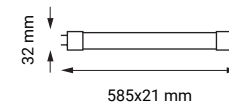

SKU: 5504 6000K
SKU: 5505 4000K
SKU: 5506 3000K

9.6W
900
Lumens

Watts	9.6W	Beam Angle	120°
Input Voltage	AC : 220-240V	CRI	Ra>80
Flux	900lm	IP Rating	IP20

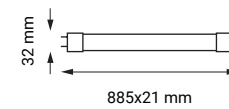

SKU: 5507 6000K
SKU: 5508 4000K
SKU: 5509 3000K

13W
1200
Lumens

Watts	13W	Beam Angle	120°
Input Voltage	AC : 220-240V	CRI	Ra>80
Flux	1200lm	IP Rating	IP20

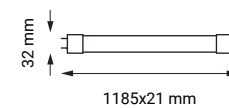

SKU: 5538 6000K
SKU: 5539 4000K
SKU: 5540 3000K



With Starter



Rotatable

LED TUBE T8 **PF>0.9****High Lumen****Nano Plastic - One Side Power**

 5
 Years
 Warranty

 160
 Lumen/W

 HIGH
 Lumens

270°

IP20

7W

Product code	TU7-A3	Beam Angle	270°
Watts	7W	CRI	Ra>80
Input Voltage	AC : 175-250V	IP Rating	IP20
Flux	1140lm	Instant Start	<0.5s

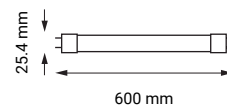
 SKU: 5541 SKU: 5542 SKU: 5543
 6000K 4500K 2800K

With Starter



Rotatable

LED TUBE T8 **PF>0.9****Nano Plastic - One Side Power**

 5
 Years
 Warranty

 HIGH
 Lumens

270°

IP20

9W

Product code	TU9-A3	Beam Angle	270°
Watts	9W	CRI	Ra>80
Input Voltage	AC : 175-250V	IP Rating	IP20
Flux	900lm	Instant Start	<0.5s

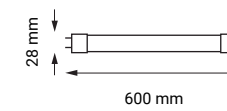
 SKU: 5511 SKU: 5512 SKU: 5513
 6000K 4500K 2800K
12W

Product code	TU12-A3	Beam Angle	270°
Watts	12W	CRI	Ra>80
Input Voltage	AC : 175-250V	IP Rating	IP20
Flux	1920lm	Instant Start	<0.5s

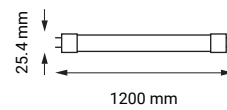
 SKU: 5544 SKU: 5545 SKU: 5546
 6000K 4500K 2800K
18W

Product code	TU18-A3	Beam Angle	270°
Watts	18W	CRI	Ra>80
Input Voltage	AC : 175-240V	IP Rating	IP20
Flux	1800lm	Instant Start	<0.5s

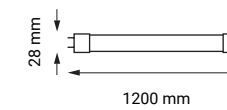
 SKU: 5514 SKU: 5515 SKU: 5516
 6000K 4500K 2800K
16W

Product code	TU16-A3	Beam Angle	270°
Watts	16W	CRI	Ra>80
Input Voltage	AC : 175-250V	IP Rating	IP20
Flux	2560lm	Instant Start	<0.5s

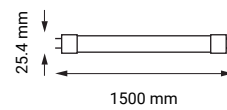

 SKU: 5547 SKU: 5548 SKU: 5549
 6000K 4500K 2800K
22W

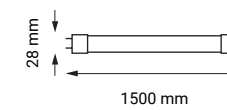
Product code	TU22-A3	Beam Angle	270°
Watts	22W	CRI	Ra>80
Input Voltage	AC : 175-250V	IP Rating	IP20
Flux	2400lm	Instant Start	<0.5s

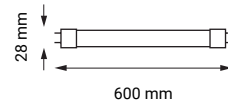

 SKU: 5517 SKU: 5518 SKU: 5519
 6000K 4500K 2800K

LED TUBE T8 **PF>0.9****PRO - Line****Glass - One Side Power****9W**1000
Lumens

Product code	TU9-A4	Beam Angle	270°
Watts	9W	CRI	Ra>80
Input Voltage	AC : 175-265V	IP Rating	IP20
Flux	1000lm	Instant Start	<0.5s

 SKU: 5614 SKU:5615
 6000K 4500K
LED TUBE T8 **PF>0.9****City Line****Glass - One Side Power****9W**900
Lumens

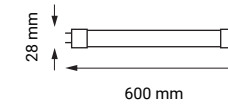
Product code	TU9-A2	Beam Angle	270°
Watts	9W	CRI	Ra>80
Input Voltage	AC : 175-265V	IP Rating	IP20
Flux	800lm	Instant Start	<0.5s

 SKU: 5601 SKU:5602 SKU: 5603
 6000K 4500K 2800K
18W2100
Lumens

Product code	TU18-A4	Beam Angle	270°
Watts	18W	CRI	Ra>80
Input Voltage	AC : 175-265V	IP Rating	IP20
Flux	2100lm	Instant Start	<0.5s

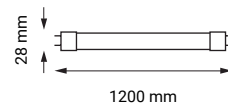
 SKU: 5617 SKU:5618
 6000K 4500K
18W1800
Lumens

Product code	TU18-A2	Beam Angle	270°
Watts	18W	CRI	Ra>80
Input Voltage	AC : 175-265V	IP Rating	IP20
Flux	1600lm	Instant Start	<0.5s

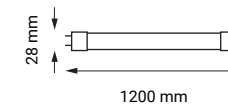
 SKU: 5604 SKU:5605 SKU: 5606
 6000K 4500K 2800K
24W2800
Lumens

Product code	TU24-A1	Beam Angle	270°
Watts	24W	CRI	Ra>80
Input Voltage	AC : 175-265V	IP Rating	IP20
Flux	3000lm	Instant Start	<0.5s

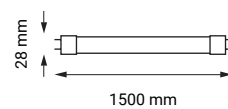
 SKU: 5610 SKU:5611
 6000K 4500K
22W2200
Lumens

Product code	TU22-A2	Beam Angle	270°
Watts	22W	CRI	Ra>80
Input Voltage	AC : 175-265V	IP Rating	IP20
Flux	2560lm	Instant Start	<0.5s

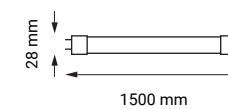
 SKU: 5607 SKU:5608 SKU: 5609
 6000K 4500K 2800K



With Starter

LED TUBE T8 PF>0.9
Professional edition
Aluminium-One Side Power

140°



IP20

9W**810**

Lumens

Product code	TU9-A1	Beam Angle	140°
Watts	9W	CRI	Ra>80
Input Voltage	AC : 175-265V	IP Rating	IP20
Flux	810lm	Instant Start	<0.5s

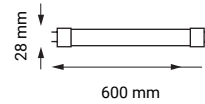

SKU: 5611-M	SKU: 5613-M	SKU: 5612-M
6000K	4500K	2800K

LED TUBE T8
Home edition
Glass - One Side Power

270°



IP20

9W**720**

Lumens

Product code	TU9-A2	Beam Angle	270°
Watts	9W	CRI	Ra>80
Input Voltage	AC : 175-265V	IP Rating	IP20
Flux	720lm	Instant Start	<0.5s

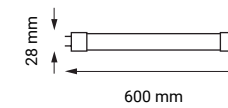

SKU: 5626	SKU: 5627
6000K	4000K

18W**1440**

Lumens

Product code	TU18-A1	Beam Angle	140°
Watts	18W	CRI	Ra>80
Input Voltage	AC : 175-265V	IP Rating	IP20
Flux	1440lm	Instant Start	<0.5s

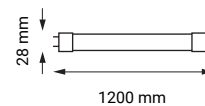

SKU: 5623-M	SKU: 5624-M
6000K	2800K

18W**1440**

Lumens

Product code	TU18-A2	Beam Angle	270°
Watts	18W	CRI	Ra>80
Input Voltage	AC : 175-265V	IP Rating	IP20
Flux	1440lm	Instant Start	<0.5s

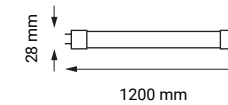

SKU: 5629	SKU: 5630
6000K	4000K

22W**1700**

Lumens

Product code	TU22-A1	Beam Angle	140°
Watts	22W	CRI	Ra>80
Input Voltage	AC : 175-265V	IP Rating	IP20
Flux	1700lm	Instant Start	<0.5s

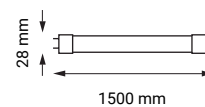

SKU: 5643-M
2800K





M12 cable gland



LED FIXTURES WITH T8 TUBES

Single City Line - Glass PF>0.9**One Side Power**

180°



IP65

9W

800

Lumens

Product code	OT1-A9	Beam Angle	180°
Watts	9W	CRI	Ra>80
Input Voltage	AC : 220-240V	IP Rating	IP65
Flux	800lm	Instant Start	<0.5s

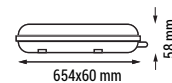
SKU: 6731
6000KSKU:6732
4500K**18W**

1600

Lumens

Product code	OT1-A9	Beam Angle	180°
Watts	18W	CRI	Ra>80
Input Voltage	AC : 220-240V	IP Rating	IP65
Flux	1600lm	Instant Start	<0.5s

SKU: 6735
6000KSKU:6736
4500K**22W**

2000

Lumens

Product code	OT1-A9	Beam Angle	180°
Watts	22W	CRI	Ra>80
Input Voltage	AC : 220-240V	IP Rating	IP65
Flux	2000lm	Instant Start	<0.5s

SKU: 6739
6000KSKU:6740
4500K

Single T8 Tube Fixture - Without Tubes

For One Side Power

SKU: 6650 For Single LED Tube 9W-60cm

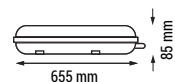

SKU: 6652 For Single LED Tube 18W-120cm

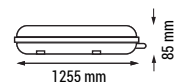

SKU: 6654 For Single LED Tube 22W-150cm



LED FIXTURES WITH T8 TUBES

Double City Line - Glass PF>0.9**One Side Power**

180°



IP65

2*9W

1600

Lumens

Product code	OT1-B1	Beam Angle	180°
Watts	2*9W	CRI	Ra>80
Input Voltage	AC : 220-240V	IP Rating	IP65
Flux	1600lm	Instant Start	<0.5s

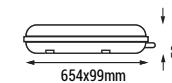
SKU: 6733
6000KSKU:6734
4500K**2*18W**

3200

Lumens

Product code	OT1-B1	Beam Angle	180°
Watts	2*18W	CRI	Ra>80
Input Voltage	AC : 220-240V	IP Rating	IP65
Flux	3200lm	Instant Start	<0.5s

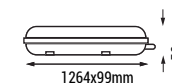
SKU: 6737
6000KSKU:6738
4500K**2*22W**

4000

Lumens

Product code	OT1-B1	Beam Angle	180°
Watts	2*22W	CRI	Ra>80
Input Voltage	AC : 220-240V	IP Rating	IP65
Flux	4000lm	Instant Start	<0.5s

SKU: 6741
6000KSKU:6742
4500K

Double T8 Tube Fixture - Without Tubes

For One Side Power

SKU: 6651 For Two LED Tube 9W-60cm



SKU: 6653 For Two LED Tube 18W-120cm

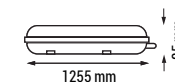

SKU: 6655 For Two LED Tube 22W-150cm

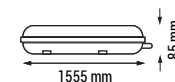



M12 cable gland



Stainless steel clips

40W LED
IP65 Fixture Type
Stainless steel clips

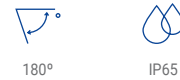
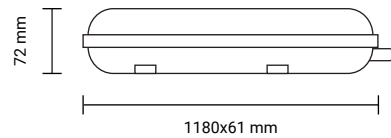

40W 4000 Lumens	Product code	OT40-A1	Beam Angle	180°
	Watts	40W	CRI	Ra>80
	Input Voltage	AC : 220-240V	IP Rating	IP65
	Flux	4000lm	Instant Start	<0.5s

SKU: 6701 SKU:6702
6000K 4500K



M12 cable gland



Stainless steel clips

55W LED
IP65 Fixture Type
Stainless steel clips

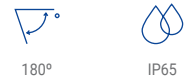
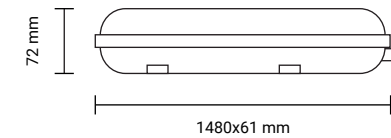

55W 6000 Lumens	Product code	OT55-A1	Beam Angle	180°
	Watts	55W	CRI	Ra>80
	Input Voltage	AC : 220-240v	IP Rating	IP65
	Flux	6000lm	Instant Start	<0.5s

SKU: 6703 SKU:6704
6000K 4500K

40W 4000 Lumens	Product code	OT40-A1	Beam Angle	180°
	Watts	40W	CRI	Ra>80
	Input Voltage	AC : 220-240V	IP Rating	IP65
	Flux	4000lm	Instant Start	<0.5s



SKU: 6705 SKU:6706
6000K 4500K

55W 6000 Lumens	Product code	OT55-A1	Beam Angle	180°
	Watts	55W	CRI	Ra>80
	Input Voltage	AC : 220-240V	IP Rating	IP65
	Flux	6000lm	Instant Start	<0.5s



SKU: 6707 SKU:6708
6000K 4500K

40W 4000 Lumens	Product code	TU40-A1	Beam Angle	180°
	Watts	40W	CRI	Ra>80
	Input Voltage	AC : 220-240V	IP Rating	IP65
	Flux	4000lm	Instant Start	<0.5s



SKU: 6709 SKU:6710
6000K 4500K

55W 6000 Lumens	Product code	OT55-A1	Beam Angle	180°
	Watts	55W	CRI	Ra>80
	Input Voltage	AC :220-240V	IP Rating	IP65
	Flux	6000lm	Instant Start	<0.5s

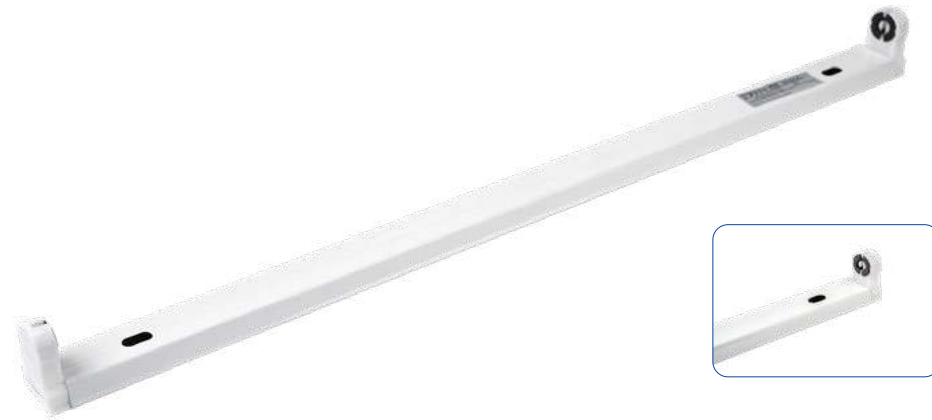

SKU: 6711 SKU:6712
6000K 4500K

**Single T8 Fixture
for LED One Side Power Tube**

Product code	OT1-A7	IP Rating	IP20
Socket	T8	Dimension	606x33mm;1250x33mm
Input Voltage	AC : 220-240V	Body Colors	White
Material	Metal+PC	Max Power	100W

SKU: 6745 1xT8-60cm Tube
SKU: 6746 1xT8-120cm Tube

**Double T8 Fixture
for LED One Side Power Tube**



Product code	OT1-A7	IP Rating	IP20
Socket	2xT8	Dimension	606x73mm;1250x73mm
Input Voltage	AC : 220-240V	Body Colors	White
Material	Metal+PC	Max Power	100W

SKU: 6747 2xT8-60cm Tube
SKU: 6748 2xT8-120cm Tube

**LED Batten Light PF>0.9
Stainless steel clips**

10W
1150
Lumens

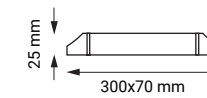
Product code	OT10-A2	Beam Angle	120°
Watts	10W	CRI	Ra>80
Input Voltage	AC : 220-240V	IP Rating	IP20
Flux	1150lm	Instant Start	<0.5s



SKU: 6671 6000K
SKU: 6672 4000K
SKU: 6673 2800K

20W
2300
Lumens

Product code	OT20-A1	Beam Angle	120°
Watts	20W	CRI	Ra>80
Input Voltage	AC : 220-240V	IP Rating	IP20
Flux	2300lm	Instant Start	<0.5s

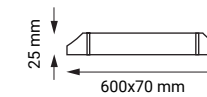

SKU: 6674 6000K
SKU: 6675 4000K
SKU: 6676 2800K

40W
3320
Lumens

Product code	OT40-A4	Beam Angle	120°
Watts	40W	CRI	Ra>80
Input Voltage	AC : 220-240V	IP Rating	IP20
Flux	3320lm	Instant Start	<0.5s

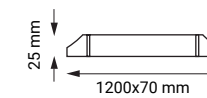

SKU: 6677 6000K
SKU: 6678 4000K
SKU: 6679 2800K

50W
4150
Lumens

Product code	OT50-A1	Beam Angle	120°
Watts	50W	CRI	Ra>80
Input Voltage	AC : 220-240V	IP Rating	IP20
Flux	4150lm	Instant Start	<0.5s

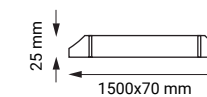

SKU: 6680 6000K
SKU: 6681 4000K

LED Batten Lights **PF>0.9****Waterproof IP65**

120°



IP65

20W**1600**

Lumens

Product code	OT20-A2	Beam Angle	120°
Watts	20W	CRI	Ra>80
Input Voltage	AC : 220-240V	IP Rating	IP65
Flux	1600lm	Instant Start	<0.5s

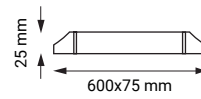
 SKU: 6691
 6000K
 SKU:6692
4000K
40W**3200**

Lumens

Product code	OT40-A5	Beam Angle	120°
Watts	40W	CRI	Ra>80
Input Voltage	AC : 220-240V	IP Rating	IP65
Flux	3200lm	Instant Start	<0.5s

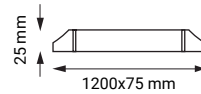
 SKU: 6694
 6000K
 SKU:6695
4000K
50W**4150**

Lumens

Product code	OT50-A2	Beam Angle	120°
Watts	50W	CRI	Ra>80
Input Voltage	AC : 220-240V	IP Rating	IP65
Flux	4150lm	Instant Start	<0.5s

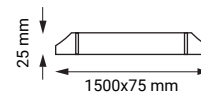
 SKU: 6697
 6000K
 SKU:6698
4000K

M12 cable gland

LED Light Fitting **PF>0.9****Stainless steel clips****With fast M12 cable gland**Flicker Free
LED

180°



IP65

18W**1800**

Lumens

Product code	OT18-A1	Beam Angle	180°
Watts	18W	CRI	Ra>80
Input Voltage	AC : 220-240V	IP Rating	IP65
Flux	1800lm	Instant Start	<0.5s

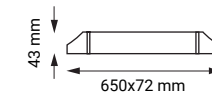
 SKU: 6721
 6000K
 SKU:6722
4000K
36W**3600**

Lumens

Product code	OT36-A1	Beam Angle	180°
Watts	36W	CRI	Ra>80
Input Voltage	AC : 175-250V	IP Rating	IP65
Flux	3600lm	Instant Start	<0.5s

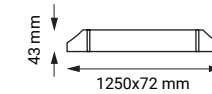
 SKU: 6723
 6000K
 SKU:6724
4000K
45W**4500**

Lumens

Product code	OT45-A1	Beam Angle	180°
Watts	45W	CRI	Ra>80
Input Voltage	AC : 220-240V	IP Rating	IP65
Flux	4500lm	Instant Start	<0.5s

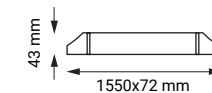
 SKU: 6725
 6000K
 SKU:6726
4000K



Industry-wide requirement throughout the entire world now, a prerequisite for all residential and business sites, OPTONICA LED covers all major subcategories.

Features:

- Up to 80% power saving
- Self-test mode with battery state indicator
- Various directions pictograms included
- 3 hours emergency operation
- Highly reliable with instant automatic on.

Application:

- Suitable for residential, industrial and commercial projects

LED EMERGENCY LIGHTS

EMERGENCY LED EXIT SIGN

An emergency light is a battery-backed lighting device that switches on automatically when a building experiences a power outage.

All bulkhead and exit signs include 4 pictograms:



Battery

● Left Arrow



● Right Arrow



● UP Arrow



● EXIT



EMERGENCY LED EXIT SIGN

Wall / Surface Mount

Product code	WW1-A1
Watts	3W
Input Voltage	AC : 220-240V
IP Rating	IP20
Battery	3.6V 900mAh Ni-Cd battery
Emergency Duration	> 3 Hours

SKU: 7203 White Light ■ 6000K



Battery



EMERGENCY LED EXIT SIGN

Wall / Surface Mount

Product code	WW1-A1
Watts	3W
Input Voltage	AC : 220-240V
IP Rating	IP20
Battery	3.6V 900mAh Ni-Cd battery
Emergency Duration	> 3 Hours

SKU: 7204 White Light ■ 6000K



Battery



EMERGENCY LED EXIT SIGN

Recessed Fixed

Product code	WW1-A1
Watts	3W
Input Voltage	AC : 220-240V
IP Rating	IP20
Battery	3.6V 900mAh Ni-Cd battery
Emergency Duration	> 3 Hours

SKU: 7206 White Light ■ 6000K



Battery



EMERGENCY LED EXIT SIGN

Recessed Hanging

Product code	WW1-A1
Watts	3W
Input Voltage	AC : 220-240V
IP Rating	IP20
Battery	3.6V 900mAh Ni-Cd battery
Emergency Duration	> 3 Hours

SKU: 7205 White Light ■ 6000K



Battery



EMERGENCY LED EXIT SIGN

Bulkhead

Product code	WW1-A1	
Watts	4W	Battery
Input Voltage	AC : 220-240V	
IP Rating	IP65	
Battery	3.6V 1500mAh Ni-Cd battery	
Emergency Duration	> 3 Hours	

SKU: 7201 White Light 

SKU: 7202 Recessed kit for SKU: 7201

EMERGENCY LED EXIT SIGN



Wall Mounted

Product code	WW1-A1	
Watts	3W	Battery
Input Voltage	AC : 220-240V	
IP Rating	IP20	
Battery	3.6V 1200mAh Ni-Cd battery	
Emergency Duration	> 3 Hours	

SKU: 7207 White Light 

EMERGENCY LED TWINSPOTS 3W



Wall Mount - Self Test

Product code	WW1-A2	
Watts	2x3 pcs 0.5W	280 Lumens
Input Voltage	AC : 220-240V	
IP Rating	IP20	Battery
Battery	3.6V 1800mAh	
Emergency Duration	> 3 Hours	

SKU: 7208 White Light 

EMERGENCY LED TWINSPOTS 6W



Wall Mount - Self Test

Product code	WW1-A2	
Watts	2x6 pcs 0.5W	450 Lumens
Input Voltage	AC : 220-240V	
IP Rating	IP20	Battery
Battery	3.6V 3000mAh	
Emergency Duration	> 3 Hours	

SKU: 7209 White Light 

EMERGENCY LED LIGHT



Downlight

Product code	WW1-A3	
Watts	3W	250 Lumens
Input Voltage	AC : 220-240V	
IP Rating	IP20	Battery
Battery	3.6V 1800mAh	
Emergency Duration	> 3 Hours	

SKU: 7210 White Light OSRAM
Chips

EMERGENCY LED LIGHT

Downlight - Osram chip

Product code	WW1-A3	
Watts	3W	460 Lumens
Input Voltage	AC : 220-240V	
IP Rating	IP20	Battery
Battery	3.6V 1800mAh	
Emergency Duration	> 3 Hours	

SKU: 7211 White Light 



Allowing full flexibility of installation on every hard surface so there are no more design restraints.

Features:

- Up to 80% power saving
- Variety of colour temperatures
- Glossy or matt finishing
- Standard sizes
- Variety of powers

Application:

- Extremely wide indoor application use – home, office, retail, hospitals, restaurants, indoor parking lots, manufacturing spaces

LED SURFACE PANELS

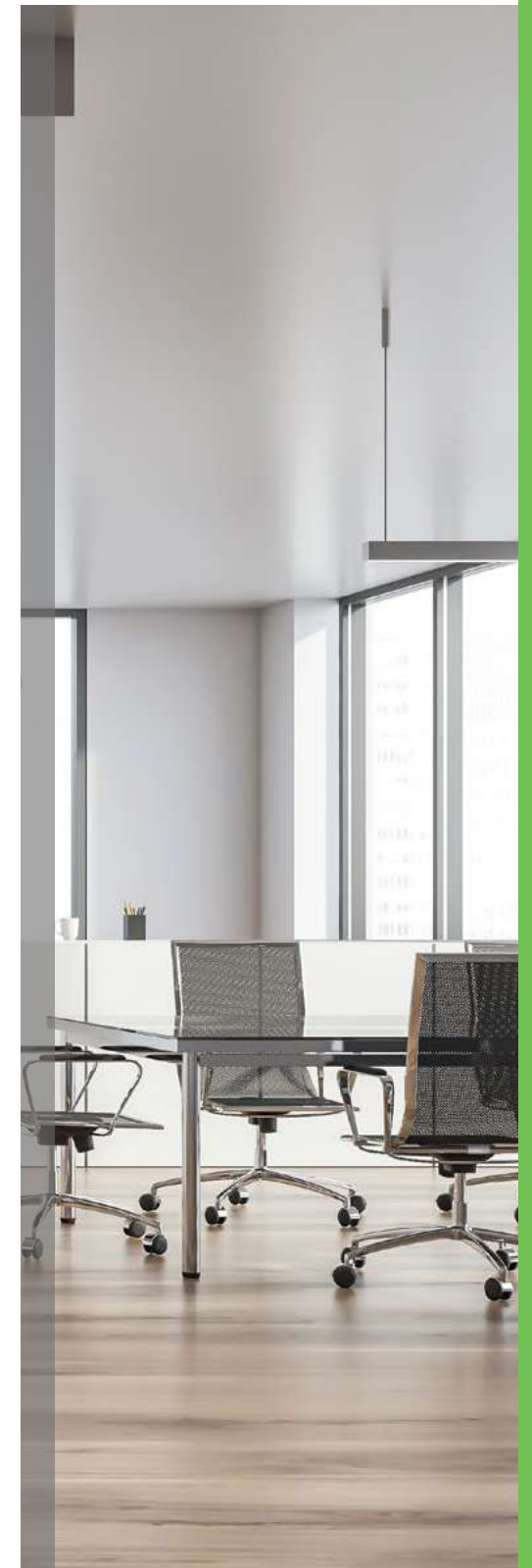

LED SURFACE PANELS



3 Years Warranty
100°
IP44

Color Changing knob

CCT - SURFACE LED PANELS
ROUND Build-in Driver

6W
450 Lumens
Product code DL6-A3
Watts 6W
Input Voltage AC : 165-265V
Flux 450lm
Beam Angle 100°
CRI Ra>80
IP Rating IP44 Front
Dimension ø115x32mm

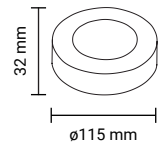

SKU: 2535
CCT - Steps
6000K 4500K 3000K

12W
950 Lumens
Product code DL12-A3
Watts 12W
Input Voltage AC : 165-265V
Flux 950lm
Beam Angle 100°
CRI Ra>80
IP Rating IP44 Front
Dimension ø170x32mm

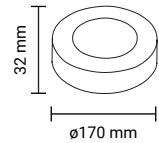

SKU: 2536
CCT - Steps
6000K 4500K 3000K

18W
1450 Lumens
Product code DL18-A3
Watts 18W
Input Voltage AC : 165-265V
Flux 1450lm
Beam Angle 100°
CRI Ra>80
IP Rating IP44 Front
Dimension ø220x32mm

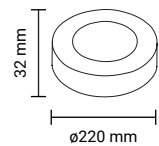

SKU: 2537
CCT - Steps
6000K 4500K 3000K

24W
2565 Lumens
Product code DL24-A3
Watts 24W
Input Voltage AC : 165-265V
Flux 2565lm
Beam Angle 100°
CRI Ra>80
IP Rating IP44 Front
Dimension ø240x32mm

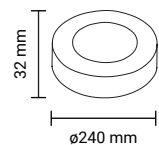

SKU: 2538
CCT - Steps
6000K 4500K 3000K



3 Years Warranty
100°
IP44

Color Changing Knob

CCT - SURFACE LED PANELS
SQUARE Build-in Driver

6W
450 Lumens
Product code DL6-A3
Watts 6W
Input Voltage AC : 165-265V
Flux 450lm
Beam Angle 100°
CRI Ra>80
IP Rating IP44 Front
Dimension 122x122x35mm

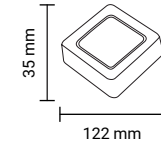

SKU: 2539
CCT - Steps
6000K 4500K 3000K

12W
950 Lumens
Product code DL12-A3
Watts 12W
Input Voltage AC : 165-265V
Flux 950lm
Beam Angle 100°
CRI Ra>80
IP Rating IP44 Front
Dimension 172x172x35mm

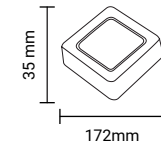

SKU: 2540
CCT - Steps
6000K 4500K 3000K

18W
1450 Lumens
Product code DL18-A3
Watts 18W
Input Voltage AC : 165-265V
Flux 1450lm
Beam Angle 100°
CRI Ra>80
IP Rating IP44 Front
Dimension 227x227x35mm

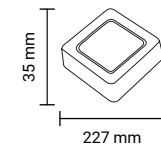

SKU: 2541
CCT - Steps
6000K 4500K 3000K

24W
2150 Lumens
Product code DL24-A3
Watts 24W
Input Voltage AC : 165-265V
Flux 2150lm
Beam Angle 100°
CRI Ra>80
IP Rating IP44 Front
Dimension 227x227x35mm

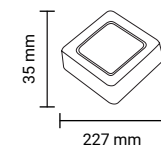

SKU: 2542
CCT - Steps
6000K 4500K 3000K



LED SURFACE PANELS

ROUND - HOME EDITION



120°



IP20

6W480
Lumens

Product code	DL6-B1	Beam Angle	120°
Watts	6W	CRI	Ra>80
Input Voltage	AC : 180-260V	IP Rating	IP20
Flux	480lm	Dimension	ø117x28mm

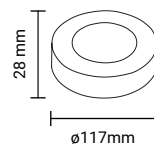

SKU: 2401	SKU: 2402	SKU: 2403
6000K	4000K	2800K

12W960
Lumens

Product code	DL12-B1	Beam Angle	120°
Watts	12W	CRI	Ra>80
Input Voltage	AC : 180-260V	IP Rating	IP20
Flux	960lm	Dimension	ø160x28mm

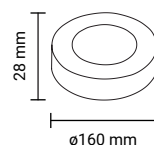

SKU: 2404	SKU: 2405	SKU: 2406
6000K	4000K	2800K

18W1440
Lumens

Product code	DL18-B1	Beam Angle	120°
Watts	18W	CRI	Ra>80
Input Voltage	AC : 180-260V	IP Rating	IP20
Flux	1440lm	Dimension	ø205x28mm

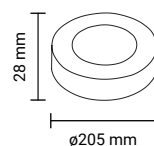

SKU: 2407	SKU: 2408	SKU: 2409
6000K	4000K	2800K

24W1920
Lumens

Product code	DL24-B1	Beam Angle	120°
Watts	24W	CRI	Ra>80
Input Voltage	AC : 180-260V	IP Rating	IP20
Flux	1920lm	Dimension	ø285x28mm

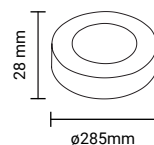

SKU: 2410	SKU: 2411	SKU: 2412
6000K	4000K	2800K



LED SURFACE PANELS

SQUARE - HOME EDITION



120°



IP20

6W480
Lumens

Product code	DL6-B1	Beam Angle	120°
Watts	6W	CRI	Ra>80
Input Voltage	AC : 180-260V	IP Rating	IP20
Flux	480lm	Dimension	118x118x28mm

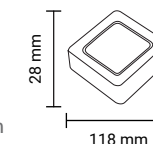

SKU: 2413	SKU: 2414	SKU: 2415
6000K	4000K	2800K

12W960
Lumens

Product code	DL12-B1	Beam Angle	120°
Watts	12W	CRI	Ra>80
Input Voltage	AC : 180-260V	IP Rating	IP20
Flux	960lm	Dimension	160x160x28mm

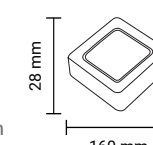

SKU: 2416	SKU: 2417	SKU: 2418
6000K	4000K	2800K

18W1440
Lumens

Product code	DL18-B1	Beam Angle	120°
Watts	18W	CRI	Ra>80
Input Voltage	AC : 180-260V	IP Rating	IP20
Flux	1440lm	Dimension	208x208x28mm

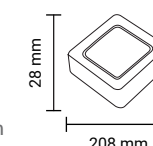

SKU: 2419	SKU: 2420	SKU: 2421
6000K	4000K	2800K

24W1920
Lumens

Product code	DL24-B1	Beam Angle	120°
Watts	24W	CRI	Ra>80
Input Voltage	AC : 180-260V	IP Rating	IP20
Flux	1920lm	Dimension	288x288x28mm

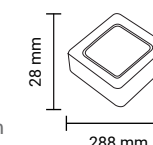

SKU: 2422	SKU: 2423	SKU: 2424
6000K	4000K	2800K

**LED SURFACE PANELS
ROUND**

120°



IP20

6W**480**

Lumens

Product code	DL6-A1	Beam Angle	120°
Watts	6W	CRI	Ra>80
Input Voltage	AC : 85-260V	IP Rating	IP20
Flux	480lm	Dimension	ø120x38mm

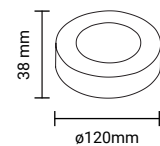
 SKU: 2231 SKU:2243 SKU: 2232
 6000K 4000K 2800K
12W**960**

Lumens

Product code	DL12-A1	Beam Angle	120°
Watts	12W	CRI	Ra>80
Input Voltage	AC : 85-260V	IP Rating	IP20
Flux	960lm	Dimension	ø172x38mm

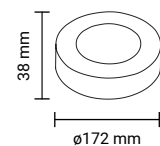
 SKU: 2244 SKU:2245 SKU: 2246
 6000K 4000K 2800K
18W**1440**

Lumens

Product code	DL18-A1	Beam Angle	120°
Watts	18W	CRI	Ra>80
Input Voltage	AC : 85-260V	IP Rating	IP20
Flux	1440lm	Dimension	ø225x38mm

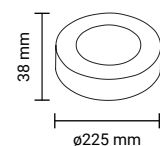
 SKU: 2235 SKU:2247 SKU: 2236
 6000K 4000K 2800K
24W**1920**

Lumens

Product code	DL24-A1	Beam Angle	120°
Watts	24W	CRI	Ra>80
Input Voltage	AC : 85-260V	IP Rating	IP20
Flux	1920lm	Dimension	ø300x38mm

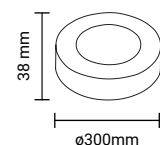
 SKU: 2248 SKU:2249 SKU: 2250
 6000K 4000K 2800K

**LED SURFACE PANELS
SQUARE**

120°



IP20

6W**480**

Lumens

Product code	DL6-A1	Beam Angle	120°
Watts	6W	CRI	Ra>80
Input Voltage	AC : 85-260V	IP Rating	IP20
Flux	480lm	Dimension	120x120x38mm

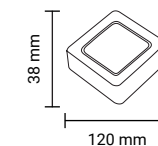
 SKU: 2237 SKU:2251 SKU: 2238
 6000K 4000K 2800K
12W**960**

Lumens

Product code	DL12-A1	Beam Angle	120°
Watts	12W	CRI	Ra>80
Input Voltage	AC :85-260V	IP Rating	IP20
Flux	960lm	Dimension	167x167x38mm

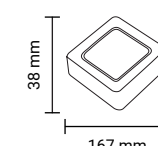
 SKU: 2252 SKU:2253 SKU: 2254
 6000K 4000K 2800K
18W**1440**

Lumens

Product code	DL18-A1	Beam Angle	120°
Watts	18W	CRI	Ra>80
Input Voltage	AC : 85-260V	IP Rating	IP20
Flux	1440lm	Dimension	220x220x32mm

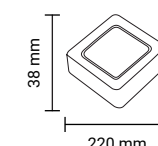
 SKU: 2241 SKU:2255 SKU: 2242
 6000K 4000K 2800K
24W**1920**

Lumens

Product code	DL24-A1	Beam Angle	120°
Watts	24W	CRI	Ra>80
Input Voltage	AC : 85-260V	IP Rating	IP20
Flux	1920lm	Dimension	295x295x32mm

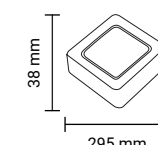
 SKU: 2256 SKU:2257 SKU: 2258
 6000K 4000K 2800K



LED CEILING LIGHT



LED ceiling lights are increasingly popular and are available in all shapes and sizes, with high-quality fittings available for any type of room. Whether you have a stately home or a terraced house, you can use these lamps to good effect.

Features:

- Up to 80% power saving
- Variety of colour temperatures
- Glossy or matt finishing
- Standard sizes
- Variety of powers

Application:

- Suspended ceilings
- Indoor use – home or office
- Large spaces



LED CEILING LIGHT

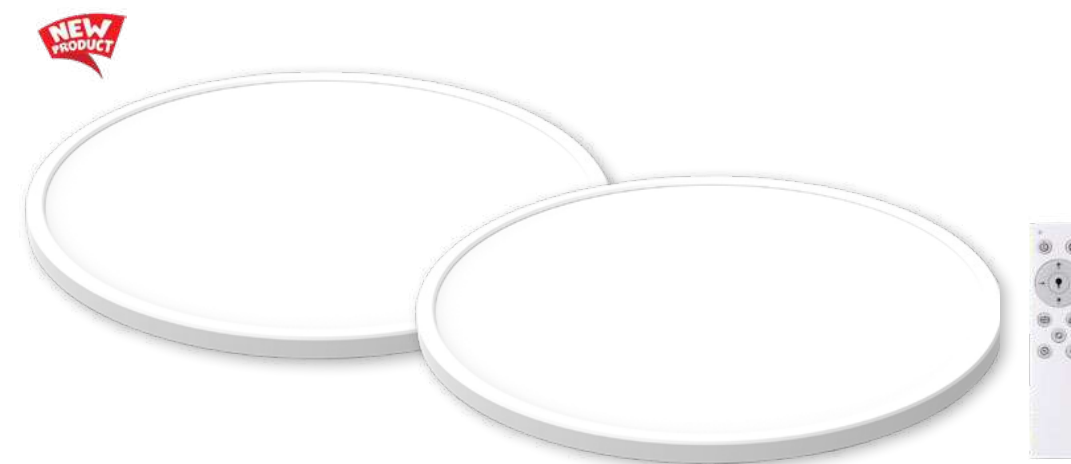
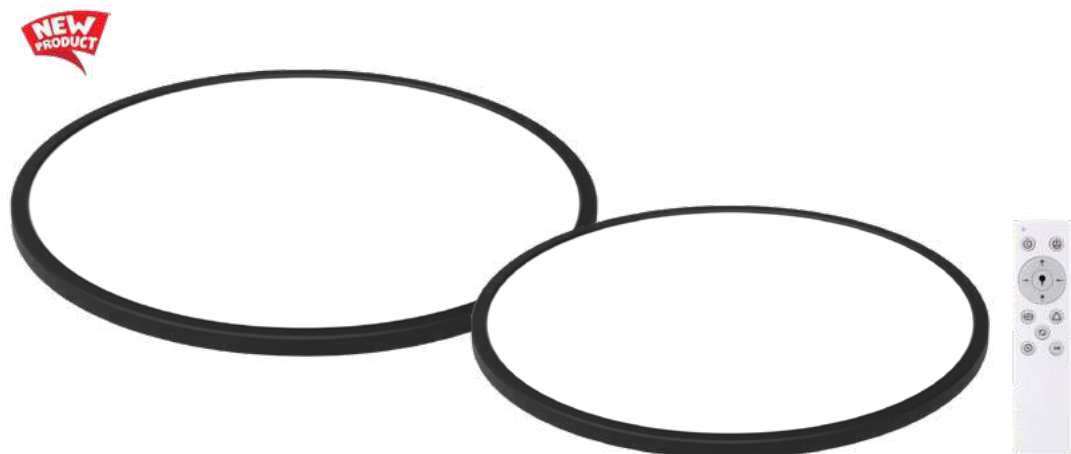

LED CEILING LIGHTS

Black Round - CCT + RGB



LED CEILING LIGHTS

White Round - CCT + RGB



18W

1440
Lumens

Watts	18W	Beam Angle	120°
Input Voltage	AC : 220-240V	CRI	Ra>80
Flux	1440lm	IP Rating	IP20

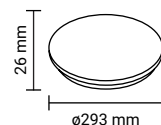

SKU: 2941
RGB + CCT
6000K 4500K 3000K

18W

1440
Lumens

Watts	18W	Beam Angle	120°
Input Voltage	AC : 220-240V	CRI	Ra>80
Flux	1440lm	IP Rating	IP20

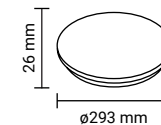

SKU: 2944
RGB + CCT
6000K 4500K 3000K

24W

1920
Lumens

Watts	24W	Beam Angle	120°
Input Voltage	AC : 220-240V	CRI	Ra>80
Flux	1920lm	IP Rating	IP20

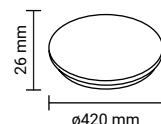

SKU: 2942
RGB + CCT
6000K 4500K 3000K

24W

1920
Lumens

Watts	24W	Beam Angle	120°
Input Voltage	AC : 220-240V	CRI	Ra>80
Flux	1920lm	IP Rating	IP20

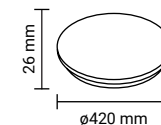

SKU: 2945
RGB + CCT
6000K 4500K 3000K

32W

2560
Lumens

Watts	32W	Beam Angle	120°
Input Voltage	AC : 220-240V	CRI	Ra>80
Flux	2560lm	IP Rating	IP20

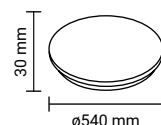

SKU: 2943
RGB + CCT
6000K 4500K 3000K

32W

2560
Lumens

Watts	32W	Beam Angle	120°
Input Voltage	AC : 220-240V	CRI	Ra>80
Flux	2560lm	IP Rating	IP20

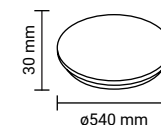

SKU: 2946
RGB + CCT
6000K 4500K 3000K



LED CEILING LIGHTS

Round - CCT Switch



18W

1880
Lumens

Watts	18W	Beam Angle	120°
Input Voltage	AC : 220-240V	CRI	Ra>80
Flux	1880lm	IP Rating	IP54

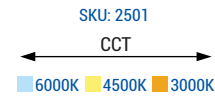
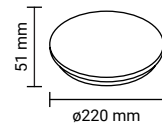

LED CEILING LIGHTS

Square - CCT Switch



18W

1880
Lumens

Watts	18W	Beam Angle	120°
Input Voltage	AC : 220-240V	CRI	Ra>80
Flux	1880lm	IP Rating	IP54

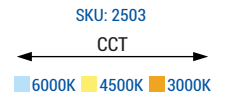
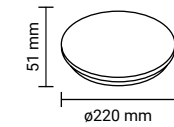

24W

2565
Lumens

Watts	24W	Beam Angle	120°
Input Voltage	AC : 220-240V	CRI	Ra>80
Flux	2565lm	IP Rating	IP54

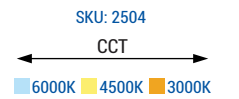
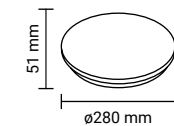

18W

1880
Lumens



Watts	18W	Beam Angle	120°
Input Voltage	AC : 220-240V	CRI	Ra>80
Flux	1880lm	IP Rating	IP54

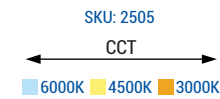
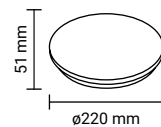

18W

1880
Lumens



Watts	18W	Beam Angle	120°
Input Voltage	AC : 220-240V	CRI	Ra>80
Flux	1880lm	IP Rating	IP54

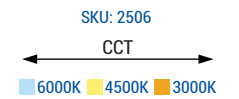
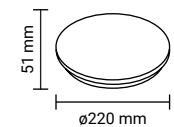



LED CEILING LIGHTS

Black Body - Round



NON-Dimmable



120°



IP20

18W



Lumens

Product code	PD18-A2	Beam Angle	120°
Watts	18W	CRI	Ra>80
Input Voltage	AC : 175-260V	IP Rating	IP20
Flux	1350lm	Body Color	Black

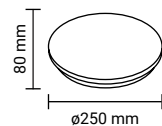

SKU:2901 4500K
SKU: 2902 3000K



LED CEILING LIGHTS

White Body - Round



NON-Dimmable



120°



IP20

18W



Lumens

Product code	PD18-A2	Beam Angle	120°
Watts	18W	CRI	Ra>80
Input Voltage	AC : 175-260V	IP Rating	IP20
Flux	1350lm	Body Color	White

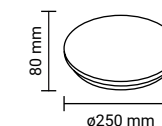

SKU:2903 4500K
SKU: 2904 3000K

30W



Lumens

Product code	PD30-A2	Beam Angle	120°
Watts	30W	CRI	Ra>80
Input Voltage	AC : 175-260V	IP Rating	IP20
Flux	2250lm	Body Color	Black

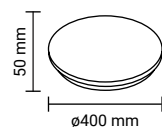

SKU:2905 4500K
SKU: 2906 3000K

30W



Lumens

Product code	PD30-A2	Beam Angle	120°
Watts	30W	CRI	Ra>80
Input Voltage	AC : 175-260V	IP Rating	IP20
Flux	2250lm	Body Color	White

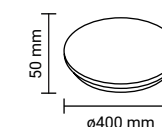

SKU:2907 4500K
SKU: 2908 3000K

54W



Lumens

Product code	PD54-A2	Beam Angle	120°
Watts	54W	CRI	Ra>80
Input Voltage	AC : 175-260V	IP Rating	IP20
Flux	4050lm	Body Color	Black

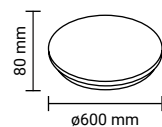

SKU:2909 4500K
SKU: 2910 3000K

54W



Lumens

Product code	PD54-A2	Beam Angle	120°
Watts	54W	CRI	Ra>80
Input Voltage	AC : 175-260V	IP Rating	IP20
Flux	4050lm	Body Color	White

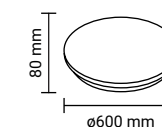

SKU:2911 4500K
SKU: 2912 3000K

LED CEILING LIGHTS

36W - Black

Product code DL36-A2
 Watts 36W
 Input Voltage AC : 175-260V
 Flux 2700lm
 Beam Angle 120°
 Shape Round

SKU:2913 SKU: 2914
 ■ 4500K ■ 3000K

CRI Ra>80
 IP Rating IP20
 Dimension ø500x80 mm
 Body Color Black
 Dimmable NO

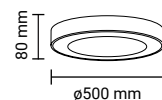

LED CEILING LIGHTS

36W - White

Product code DL36-A2
 Watts 36W
 Input Voltage AC : 175-260V
 Flux 2700lm
 Beam Angle 120°
 Shape Round

SKU:2915 SKU: 2916
 ■ 4500K ■ 3000K

CRI Ra>80
 IP Rating IP20
 Dimension ø500x80 mm
 Body Color White
 Dimmable NO

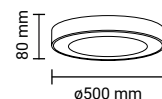

LED CEILING LIGHTS

30W - Black

Product code DL36-A2
 Watts 36W
 Input Voltage AC : 175-260V
 Flux 2250lm
 Beam Angle 120°
 Shape Square

SKU:2919 SKU: 2920
 ■ 4500K ■ 3000K

CRI Ra>80
 IP Rating IP20
 Dimension 380x380 mm
 Body Color Black
 Dimmable NO

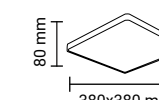

LED CEILING LIGHTS

30W - White

Product code DL36-A2
 Watts 36W
 Input Voltage AC : 175-260V
 Flux 2250lm
 Beam Angle 120°
 Shape Square

SKU:2923 SKU: 2924
 ■ 4500K ■ 3000K

CRI Ra>80
 IP Rating IP20
 Dimension 380x380 mm
 Body Color White
 Dimmable NO

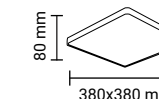

LED CEILING LIGHTS

64W - Black

Product code DL64-A2
 Watts 64W
 Input Voltage AC : 175-260V
 Flux 4800lm
 Beam Angle 120°
 Shape Round

SKU:2917 SKU: 2918
 ■ 4500K ■ 3000K

CRI Ra>80
 IP Rating IP20
 Dimension ø800x80 mm
 Body Color Black
 Dimmable NO

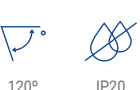
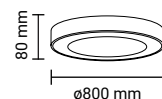

LED CEILING LIGHTS

64W - Black

Product code DL64-A2
 Watts 64W
 Input Voltage AC : 175-260V
 Flux 4800lm
 Beam Angle 120°
 Shape Square

SKU:2925 SKU: 2926
 ■ 4500K ■ 3000K

CRI Ra>80
 IP Rating IP20
 Dimension 600x600 mm
 Body Color Black
 Dimmable NO

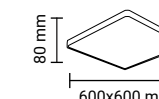

LED CEILING LIGHTS

64W - White

Product code DL64-A2
 Watts 64W
 Input Voltage AC : 175-260V
 Flux 4800lm
 Beam Angle 120°
 Shape Round

SKU:2919 SKU: 2920
 ■ 4500K ■ 3000K

CRI Ra>80
 IP Rating IP20
 Dimension ø800x80 mm
 Body Color White
 Dimmable NO

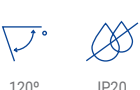
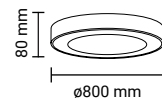

LED CEILING LIGHTS

64W - White

Product code DL64-A2
 Watts 64W
 Input Voltage AC : 175-260V
 Flux 4800lm
 Beam Angle 120°
 Shape Square

SKU:2927 SKU: 2928
 ■ 4500K ■ 3000K

CRI Ra>80
 IP Rating IP20
 Dimension 600x600 mm
 Body Color White
 Dimmable NO

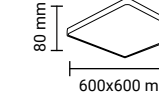



Remote Control

LED CEILING LIGHTS

Sandy White - Round



Product code	DL72-A1	CRI	Ra>80
Watts	36x2W	IP Rating	IP20
Input Voltage	AC : 180-260V	Dimension	ø500x50 mm
Flux	5400lm	Body Color	White
Beam Angle	120°	Dimmable	NO
Shape	Round		

SKU: 2931 ← CCT →
■ 6000K ■ 4500K ■ 3000K



Remote Control

LED CEILING LIGHTS

Sandy White - Round



Product code	DL96-A1	CRI	Ra>80
Watts	48x2W	IP Rating	IP20
Input Voltage	AC : 180-260V	Dimension	ø500x50 mm
Flux	7200lm	Body Color	White
Beam Angle	120°	Dimmable	NO
Shape	Round		

SKU: 2930 ← CCT →
■ 6000K ■ 4500K ■ 3000K



Remote Control

LED CEILING LIGHTS

Sandy White - Square



Product code	DL120-A1	CRI	Ra>80
Watts	60x2W	IP Rating	IP20
Input Voltage	AC : 180-260V	Dimension	500x500x50 mm
Flux	9000lm	Body Color	White
Beam Angle	120°	Dimmable	NO
Shape	Square		

SKU: 2929 ← CCT → 3800156629295
■ 6000K ■ 4500K ■ 3000K

Ceiling plate for pendant lamps
Does not contain pendant lamps

HANGING ACCESSORIES

Black SKU: 5181



HANGING ACCESSORIES

White SKU: 5180



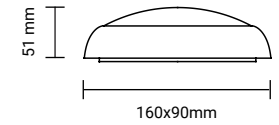

LED SURFACE CEILING

Bulkhead-Thermoplastic

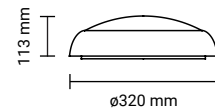
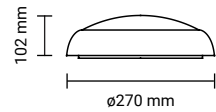

LED SURFACE CEILING 8W

Bulkhead-Thermoplastic

Watts	8W	CRI	Ra>80
Input Voltage	AC : 220-240V	IP Rating	IP54
Flux	600lm	Dimension	160x90x51 mm
Beam Angle	120°	Body Color	White
Shape	Bulkhead	Dimmable	NO

SKU: 2801	SKU: 2802	SKU: 2803
6000K	4000K	2700K

8W	Product code	DL8-A3	Beam Angle	120°
640 Lumens	Watts	8W	CRI	Ra>80
	Input Voltage	AC : 220-240V	IP Rating	IP65
	Flux	640lm	Instant Start	<0.5s

SKU: 2807	SKU: 2808
4500K	2700K

13W	Product code	DL13-A1	Beam Angle	120°
1050 Lumens	Watts	13W	CRI	Ra>80
	Input Voltage	AC : 220-240V	IP Rating	IP65
	Flux	1050lm	Instant Start	<0.5s

SKU: 2813	SKU: 2814
4500K	2700K

8W	Product code	DL8-A4	Beam Angle	120°
640 Lumens	Watts	8W	CRI	Ra>80
	Input Voltage	AC : 220-240V	IP Rating	IP65
	Flux	640lm	Instant Start	<0.5s



SKU: 2809	SKU: 2810
4500K	2700K

13W	Product code	DL13-A3	Beam Angle	120°
1050 Lumens	Watts	13W	CRI	Ra>80
	Input Voltage	AC : 220-240V	IP Rating	IP65
	Flux	1050lm	Instant Start	<0.5s



SKU: 2815	SKU: 2816
4500K	2700K

8W	Product code	DL8-A5	Beam Angle	120°
640 Lumens	Watts	8W	CRI	Ra>80
	Input Voltage	AC : 220-240V	IP Rating	IP65
	Flux	640lm	Instant Start	<0.5s



SKU: 2811	SKU: 2812
4500K	2700K

13W	Product code	DL13-A4	Beam Angle	120°
1050 Lumens	Watts	13W	CRI	Ra>80
	Input Voltage	AC : 220-240V	IP Rating	IP65
	Flux	1050lm	Instant Start	<0.5s



SKU: 2817	SKU: 2818
4500K	2700K

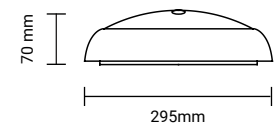
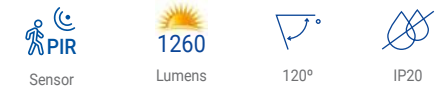

LED SURFACE CEILING 18W

Thermoplastic - PIR

Watts	18W	CRI	Ra>80
Input Voltage	AC : 220-240V	IP Rating	IP20
Flux	1260lm	Dimension	ø295x70 mm
Beam Angle	120°	Body Color	White
Shape	Round	Dimmable	NO

SKU: 2804	SKU: 2805	SKU: 2806
6000K	4000K	2700K

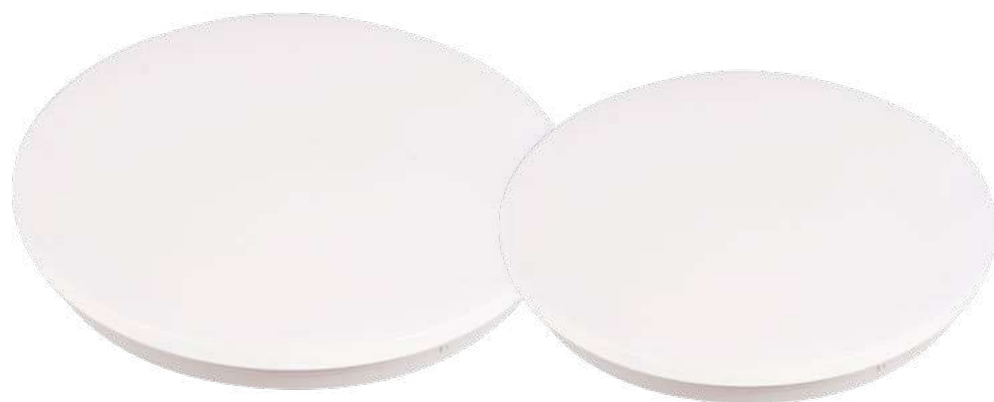

LED CEILING LIGHTS

HOME EDITION - Matt White

120°



IP20

12W**880**
Lumens

Product code	DL12-B1	Beam Angle	120°
Watts	12W	CRI	Ra>80
Input Voltage	AC : 175-265V	IP Rating	IP20
Flux	880lm	Body Color	White

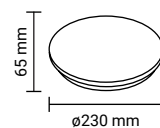
 SKU: 2870 SKU:2871 SKU: 2872
 6000K 4500K 3000K

LED CEILING LIGHTS

HOME EDITION - Dotty Sparkle

120°



IP20

12W**880**
Lumens

Product code	DL12-B1	Beam Angle	120°
Watts	12W	CRI	Ra>80
Input Voltage	AC : 175-265V	IP Rating	IP20
Flux	880lm	Body Color	White

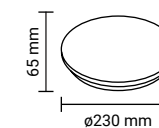
 SKU: 2879 SKU:2880 SKU: 2881
 6000K 4500K 3000K
18W**1550**
Lumens

Product code	DL18-B1	Beam Angle	120°
Watts	18W	CRI	Ra>80
Input Voltage	AC : 175-265V	IP Rating	IP20
Flux	1550lm	Body Color	White

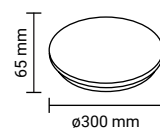
 SKU: 2873 SKU:2874 SKU: 2875
 6000K 4500K 3000K
18W**1550**
Lumens

Product code	DL18-B1	Beam Angle	120°
Watts	18W	CRI	Ra>80
Input Voltage	AC : 175-265V	IP Rating	IP20
Flux	1550lm	Body Color	White

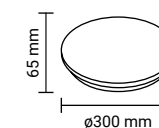
 SKU: 2882 SKU:2883 SKU: 2884
 6000K 4500K 3000K
24W**1900**
Lumens

Product code	DL24-B1	Beam Angle	120°
Watts	24W	CRI	Ra>80
Input Voltage	AC : 175-265V	IP Rating	IP20
Flux	1900lm	Body Color	White

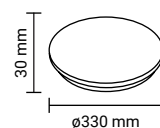
 SKU: 2876 SKU:2877 SKU: 2878
 6000K 4500K 3000K
24W**1900**
Lumens

Product code	DL24-B1	Beam Angle	120°
Watts	24W	CRI	Ra>80
Input Voltage	AC : 175-265V	IP Rating	IP20
Flux	1900lm	Body Color	White

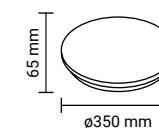
 SKU: 2885 SKU:2886 SKU: 2887
 6000K 4500K 3000K



LED CEILING LIGHTS

CITY LINE - Matt White**12W****880**

Lumens

Product code	DL12-B1	Beam Angle	120°
Watts	12W	CRI	Ra>80
Input Voltage	AC : 175-265V	IP Rating	IP20
Flux	880lm	Body Color	White

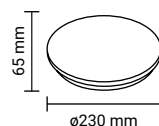

SKU: 2840	SKU:2841	SKU: 2842
6000K	4500K	3000K

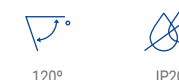

LED CEILING LIGHTS

CITY LINE - Dotty Sparkle**12W****840**

Lumens

Product code	DL12-B1	Beam Angle	120°
Watts	12W	CRI	Ra>80
Input Voltage	AC : 175-265V	IP Rating	IP20
Flux	840lm	Body Color	White

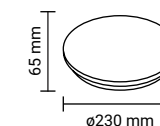

SKU: 2849	SKU:2850	SKU: 2851
6000K	4500K	3000K

18W**1550**

Lumens

Product code	DL18-B1	Beam Angle	120°
Watts	18W	CRI	Ra>80
Input Voltage	AC : 175-265V	IP Rating	IP20
Flux	1550lm	Body Color	White

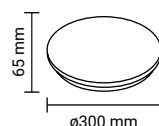

SKU: 2843	SKU:2844	SKU: 2845
6000K	4500K	3000K

18W**1260**

Lumens

Product code	DL18-B1	Beam Angle	120°
Watts	18W	CRI	Ra>80
Input Voltage	AC : 175-265V	IP Rating	IP20
Flux	1260lm	Body Color	White

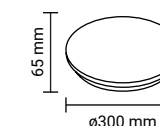

SKU: 2852	SKU:2853	SKU: 2854
6000K	4500K	3000K

24W**1900**

Lumens

Product code	DL24-B1	Beam Angle	120°
Watts	24W	CRI	Ra>80
Input Voltage	AC : 175-265V	IP Rating	IP20
Flux	1900lm	Body Color	White

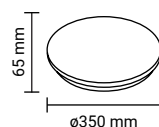

SKU: 2846	SKU:2847	SKU: 2848
6000K	4500K	3000K

24W**1900**

Lumens

Product code	DL24-B1	Beam Angle	120°
Watts	24W	CRI	Ra>80
Input Voltage	AC : 175-265V	IP Rating	IP20
Flux	1900lm	Body Color	White

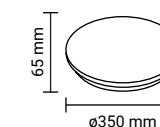

SKU: 2855	SKU:2856	SKU: 2857
6000K	4500K	3000K



Remote Control included



Color changing LED 3000 to 6000K

LED Ceiling Light 36W PF>0.9
Matt White



2500 Lumens



SKU: 2858 3800156628588

6000K 4500K 3000K

Product code	DL36-A4	Remote	No
Watts	36W	CRI	Ra>80
Input Voltage	AC : 185-265V	IP Rating	IP20
Flux	2500lm	Dimension	ø460x70 mm
Beam Angle	120°	Body Color	Matt White
Shape	Round	Dimmable	Yes



Remote Control included



Color changing LED 3000 to 6000K

LED Ceiling Light 60W PF>0.9
Matt White



3600 Lumens



SKU: 2859 3800156628595

6000K 4500K 3000K

Product code	DL60-A4	Remote	No
Watts	60W	CRI	Ra>80
Input Voltage	AC : 185-265V	IP Rating	IP20
Flux	3600lm	Dimension	ø560x70 mm
Beam Angle	120°	Body Color	Matt White
Shape	Round	Dimmable	Yes



Remote Control included



Color changing LED 3000 to 6000K

LED Ceiling Light 36W PF>0.9
Matt White+Dotty Sparkle



2500 Lumens



SKU: 2860 3800156628601

6000K 4500K 3000K

Product code	DL36-A5	Remote	Yes
Watts	36W	CRI	Ra>80
Input Voltage	AC : 185-265V	IP Rating	IP20
Flux	2500lm	Dimension	430x430x70 mm
Beam Angle	120°	Body Color	Matt White
Shape	Square	Dimmable	Yes



Remote Control included



Color changing LED 3000 to 6000K

LED Ceiling Light 60W PF>0.9
Matt White+Dotty Sparkle



3600 Lumens



SKU: 2861 3800156628618

6000K 4500K 3000K

Product code	DL60-A5	Remote	Yes
Watts	60W	CRI	Ra>80
Input Voltage	AC : 185-265V	IP Rating	IP20
Flux	3600lm	Dimension	530x530x70 mm
Beam Angle	120°	Body Color	Matt White
Shape	Square	Dimmable	Yes



Remote Control included



Dimmable



IP20



Color changing LED 3000 to 6000K

LED Ceiling Light 36W
HOME EDITION - Allstar

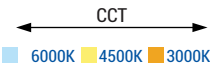
2800
 Lumens

SKU: 2888

Product code	DL36-A6	Remote	Yes
Watts	36W	CRI	Ra>80
Input Voltage	AC : 185-240V	IP Rating	IP20
Flux	2800lm	Dimension	ø380x110 mm
Beam Angle	120°	Body Color	Matt White
Shape	Round	Dimmable	Yes



Remote Control included



Dimmable



IP20



Color changing LED 3000 to 6000K

LED Ceiling Light 60W
HOME EDITION - Allstar

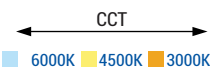
4200
 Lumens

SKU: 2889

Product code	DL60-A6	Remote	Yes
Watts	60W	CRI	Ra>80
Input Voltage	AC : 185-240V	IP Rating	IP20
Flux	4200lm	Dimension	ø485x115 mm
Beam Angle	120°	Body Color	Matt White
Shape	Round	Dimmable	Yes

3
 Years
 Warranty



NON-Dimmable

 EPISTAR
 Chips

120°

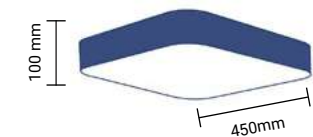

IP20



LED Ceiling Light 38W PF>0.95
Sandy White - Square

1900
 Lumens

SKU: 2297 Warm White 3000K

Product code	DL38-A1	CRI	Ra>80
Watts	38W	IP Rating	IP20
Input Voltage	AC : 175-240V	Dimension	450x450x100 mm
Flux	1900lm	Body Color	Sandy White
Beam Angle	120°	Dimmable	NO
Shape	Square		

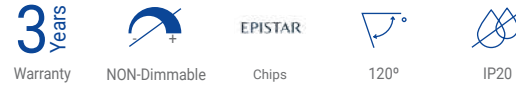
LED Suspended Lighting

Round Sandy White

LED Suspended Lighting

38W PF>0.952660
Lumens

SKU: 9036 Warm White 3000K

Watts	38W	CRI	Ra>80
Input Voltage	AC : 175-240V	IP Rating	IP20
Flux	2660lm	Dimension	ø450x1200 mm
Beam Angle	120°	Body Color	Sandy White
Shape	Round	Dimmable	NO

LED Suspended Lighting

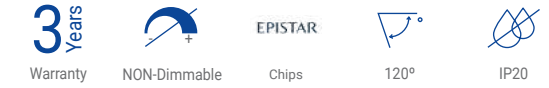
Square Sandy White

LED Suspended Lighting

38W PF>0.952660
Lumens

SKU: 9038 Warm White 3000K

Watts	38W	CRI	Ra>80
Input Voltage	AC : 175-240V	IP Rating	IP20
Flux	2660lm	Dimension	450x450x1200 mm
Beam Angle	120°	Body Color	Sandy White
Shape	Square	Dimmable	NO

LED Suspended Lighting

50W PF>0.953500
Lumens

SKU: 9037 Warm White 3000K

Watts	50W	CRI	Ra>80
Input Voltage	AC : 175-240V	IP Rating	IP20
Flux	3500lm	Dimension	ø600x1200 mm
Beam Angle	120°	Body Color	Sandy White
Shape	Round	Dimmable	NO

LED Suspended Lighting

50W PF>0.953500
Lumens

SKU: 9039 Warm White 3000K

Watts	50W	CRI	Ra>80
Input Voltage	AC : 175-240V	IP Rating	IP20
Flux	3500lm	Dimension	600x600x1200 mm
Beam Angle	120°	Body Color	Sandy White
Shape	Square	Dimmable	NO

VINTAGE PENDANTS E27



SKU: 9029 - Pearl Black



SKU: 9046 - Pearl Black



SKU: 9047 - Bronze



SKU: 9049 - Antique gold



SKU: 9028 - Rose Gold



SKU: 9048 - Rose Gold



3D Glass Barel Pendant D200
Chrome Rhombus

SKU:	9014
Product Code	PD1-A1
E27 holder	Max 40W
Material	3D Glass
IP Rating	IP20
Dimension	ø200x213mm
EAN:	3800156690141



3D Glass Barel Pendant D200
Chrome Squares

SKU:	9015
Product Code	PD1-A1
E27 holder	Max 40W
Material	3D Glass
IP Rating	IP20
Dimension	ø200x213mm
EAN:	3800156690158



3D Glass Pendant D200
Chrome Square

SKU:	9004
Product Code	PD1-A1
E27 holder	Max 40W
Material	3D Glass
IP Rating	IP20
Dimension	ø200x175mm
EAN:	3800156690042



3D Glass Pendant D200
Copper Squares

SKU:	9005
Product Code	PD1-A1
E27 holder	Max 40W
Material	3D Glass
IP Rating	IP20
Dimension	ø200x175mm
EAN:	3800156690059





3D Glass Pendant D220

Chrome Circles

SKU: **9008**
 Product Code PD1-A1
 E27 holder Max 40W
 Material 3D Glass
 IP Rating IP20
 Dimension ø220x275mm
 EAN: 3800156690080



E27 Holder



IP20



3D Glass Pendant D200

Chrome Circles

SKU: **9019**
 Product Code PD1-A1
 E27 holder Max 40W
 Material 3D Glass
 IP Rating IP20
 Dimension ø200x165mm
 EAN: 3800156690196



E27 Holder



IP20



3D Glass Pendant D220

Copper Seagull

SKU: **9009**
 Product Code PD1-A1
 E27 holder Max 40W
 Material 3D Glass
 IP Rating IP20
 Dimension ø220x275mm
 EAN: 3800156690097



E27 Holder



IP20



3D Glass Pendant D200

Chrome Seagull

SKU: **9020**
 Product Code PD1-A1
 E27 holder Max 40W
 Material 3D Glass
 IP Rating IP20
 Dimension ø200x165mm
 EAN: 3800156690202



E27 Holder



IP20



3D Glass Pendant D220

Chrome Seagull

SKU: **9011**
 Product Code PD1-A1
 E27 holder Max 40W
 Material 3D Glass
 IP Rating IP20
 Dimension ø220x275mm
 EAN: 3800156690110



E27 Holder



IP20



3D Glass Pendant D200

Copper Circles

SKU: **9021**
 Product Code PD1-A1
 E27 holder Max 40W
 Material 3D Glass
 IP Rating IP20
 Dimension ø200x165mm
 EAN: 3800156690219



E27 Holder



IP20

**3D Glass Umbrella Pendant D400
Copper Seagull**

SKU: **9017**
 Product Code PD1-A1
 E27 holder Max 40W
 Material 3D Glass
 IP Rating IP20
 Dimension ø400x200mm
 EAN: 3800156690172



E27 Holder

IP20

**3D Glass Pendant D290
Copper Circles**

SKU: **9022**
 Product Code PD1-A1
 E27 holder Max 40W
 Material 3D Glass
 IP Rating IP20
 Dimension ø290x250mm
 EAN: 3800156690226



E27 Holder

IP20

**3D Glass Umbrella Pendant D400
Chrome Circles**

SKU: **9018**
 Product Code PD1-A1
 E27 holder Max 40W
 Material 3D Glass
 IP Rating IP20
 Dimension ø400x200mm
 EAN: 3800156690189



E27 Holder

IP20

**3D Glass Pendant D290
Chrome Seagull**

SKU: **9024**
 Product Code PD1-A1
 E27 holder Max 40W
 Material 3D Glass
 IP Rating IP20
 Dimension ø290x250mm
 EAN: 3800156690240



E27 Holder

IP20

**Vintage Rope Pendant
Length 1.5m**

SKU: **9027**
 Product Code PD1-A2
 E27 holder Max 60W
 IP Rating IP20
 Dimension ø90x1500mm
 EAN: 3800156660596



E27 Holder

IP20

**3D Glass Pendant D400
Copper Fireworks**

SKU: **9026**
 Product Code PD1-A1
 E27 holder Max 40W
 Material 3D Glass
 IP Rating IP20
 Dimension ø400x345mm
 EAN: 3800156690264



E27 Holder

IP20



LED Flame Bulb
5W SMD E27



Product code	OT5-A1	CRI	Ra>80
Watts	5W	IP Rating	IP20
Input Voltage	AC : 220-240V	Dimension	ø47x125 mm
Flux	250lm	Socket	E27
Beam Angle	360°		

SKU: 222
■ 1300K



LED Flame Lamp Wall Mounted
5W SMD



Product code	PD5-A1	CRI	Ra>80
Watts	5W	IP Rating	IP20
Input Voltage	AC : 220-240V	Dimension	220xH285 mm
Flux	250lm	Beam Angle	360°
Beam Angle	360°	E27 holder	LED Flame Bulb Included

SKU: 9044
■ 1300K



LED Flame Lamp
5W SMD



Product code	PD5-A1	CRI	Ra>80
Watts	5W	IP Rating	IP20
Input Voltage	AC : 220-240V	Dimension	ø180xH285 mm
Flux	250lm	E27 holder	LED Flame Bulb Included
Beam Angle	360°		

SKU: 9041
■ 1300K



LED Flame Lamp Wall Mounted
5W SMD



Product code	PD5-A1	CRI	Ra>80
Watts	5W	IP Rating	IP20
Input Voltage	AC : 220-240V	Dimension	180xH260 mm
Flux	250lm	E27 holder	LED Flame Bulb Included
Beam Angle	360°		

SKU: 9045
■ 1300K



LED Flame Lamp With Battery
5W SMD



Product code	PD5-A1	CRI	Ra>80
Watts	5W	IP Rating	IP20
Input Voltage	AC : 220-240V	Dimension	ø180xH285 mm
Flux	250lm	E27 holder	LED Flame Bulb Included
Beam Angle	360°		

SKU: 9042
■ 1300K



LED Flame Lamp Hanging
5W SMD



Product code	PD5-A1	CRI	Ra>80
Watts	5W	IP Rating	IP20
Input Voltage	AC : 220-240V	Dimension	ø150xH330 mm
Flux	250lm	E27 holder	LED Flame Bulb Included
Beam Angle	360°		

SKU: 9043
■ 1300K



LED PANELS



LED panels offers a broad application in different lighting solutions. With variety of standard sizes they can be placed in suspended ceilings or used as hanging lights.

Features:

- Up to 80% power saving
- Build-in or hanging installations
- Variety of colour temperatures
- Glossy or matt finishing
- Standard sizes
- Variety of powers

Application:

- Suspended ceilings
- Indoor use – home or office
- Large spaces



LED PANELS

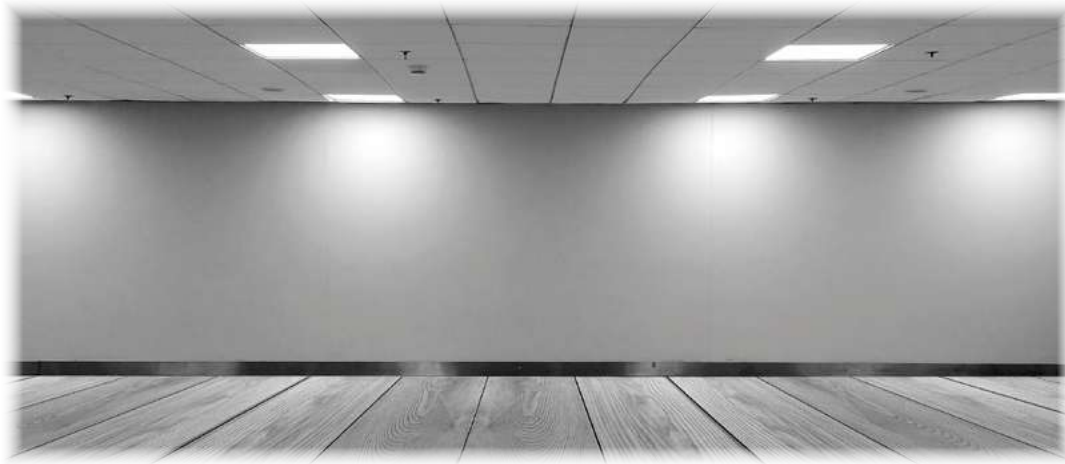

125
 Lumens/W

6 PCS
 BOX

LED PANEL PF>0.9
29W With Driver 60x60cm

Product code	DL29-A1	Beam Angle	120°
Watts	29W	CRI	Ra>80
Input Voltage	AC : 175-265V	IP Rating	IP20
Flux	3600lm	BOX Qty	6 PCS

SKU: 2382	SKU: 2383	SKU: 2384
6000K	4500K	2700K

HIGH
 Lumens

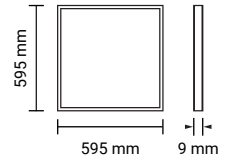
 IP20

LED PANEL PF>0.95
25W With Driver 60x60cm

3000
 Lumens

 IP20

Product code	DL25-A2	Beam Angle	120°
Watts	25W	CRI	Ra>80
Input Voltage	AC : 175-265V	IP Rating	IP20
Flux	3000lm	BOX Qty	1 PCS

TP(b)RATED
 Polycarbonate Diffuser

SKU: 2740	SKU: 2741
6000K	4500K

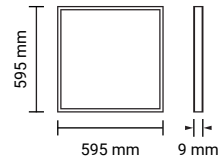
3
 Years
 Warranty

LED BACKLIT PANEL PF>0.9
30W With Driver 60x60cm

120
 Lumens/W

HIGH
 Lumens

 IP20

Product code	DL30-A3	Beam Angle	120°
Watts	30W	CRI	Ra>80
Input Voltage	AC : 220-240V	IP Rating	IP20
Flux	3600lm	BOX Qty	6 PCS

TP(a)RATED
 Polycarbonate Diffuser

SKU: 2776	SKU: 2777
6000K	4500K

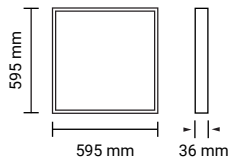

6 PCS
 BOX

LED BACKLIT PANEL PF>0.9
25W With Driver 60x60cm

HIGH
 Lumens

 IP20

Product code	DL25-A3	Beam Angle	120°
Watts	25W	CRI	Ra>80
Input Voltage	AC : 185-265V	IP Rating	IP20
Flux	4000lm	BOX Qty	10 PCS

SKU: 2770	SKU: 2771
6000K	4500K

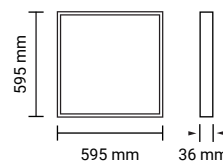

160
 Lumens/W

10 PCS
 BOX

LED PANEL
36W With Driver 60x60cm

3200
 Lumens

 IP20

Product code	DL36-A1	Beam Angle	120°
Watts	36W	CRI	Ra>80
Input Voltage	AC : 220-240V	IP Rating	IP20
Flux	3200lm	BOX Qty	6 PCS

SKU: 2350	SKU: 2363	SKU: 2351
6000K	4500K	2700K

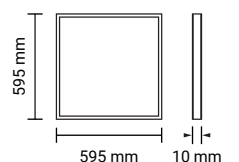

6 PCS
 BOX

LED PANEL Single Pack PF>0.9
36W With Driver 62x62cm
3600
 Lumens

 IP20

Product code	DL36-A4	Beam Angle	120°
Watts	36W	CRI	Ra>80
Input Voltage	AC : 220-240V	IP Rating	IP20
Flux	3600lm	BOX Qty	1 PCS

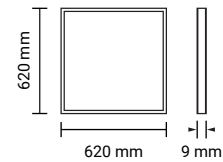
 German Standard
 SKU: 2701 SKU:2702 SKU: 2703
 6000K 4500K 2700K

LED PANEL PF>0.9
36W With Driver 60x60cm
3600
 Lumens

 IP20

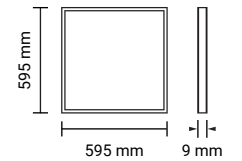
Product code	DL36-A1	Beam Angle	120°
Watts	36W	CRI	Ra>80
Input Voltage	AC : 220-240V	IP Rating	IP20
Flux	3600lm	BOX Qty	6 PCS

 SKU: 2711 SKU:2712 SKU: 2713
 6000K 4500K 2700K

LED PANEL Single Pack PF>0.9
36W With Driver 62x62cm
3600
 Lumens

 IP20

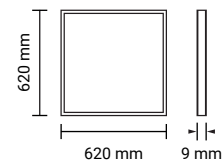
Product code	DL36-A4	Beam Angle	120°
Watts	36W	CRI	Ra>80
Input Voltage	AC : 220-240V	IP Rating	IP20
Flux	3600lm	BOX Qty	1 PCS

 German Standard
 SKU: 2704 SKU:2705 SKU: 2706
 6000K 4500K 2700K

LED PANEL PF>0.9
36W With Driver 60x60cm
3600
 Lumens

 IP20

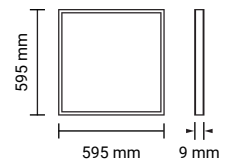
Product code	DL36-A1	Beam Angle	120°
Watts	36W	CRI	Ra>80
Input Voltage	AC : 220-240V	IP Rating	IP20
Flux	3600lm	BOX Qty	6 PCS

 SKU: 2717 SKU:2718
 6000K 4500K

LED PANEL Single Pack PF>0.9
36W With Driver 62x62cm
3600
 Lumens

 IP20

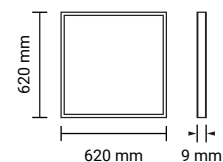

Product code	DL36-A4	Beam Angle	120°
Watts	36W	CRI	Ra>80
Input Voltage	AC : 220-240V	IP Rating	IP20
Flux	3600lm	BOX Qty	1 PCS

 German Standard
 SKU: 2707 SKU:2708
 6000K 4500K

LED PANEL PF>0.95
36W With Driver 60x60cm
3500
 Lumens

 IP20

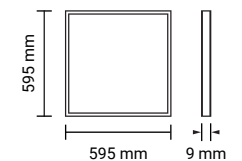
Product code	DL36-A2	Beam Angle	120°
Watts	36W	CRI	Ra>80
Input Voltage	AC : 175-265V	IP Rating	IP20
Flux	3500lm	BOX Qty	1 PCS

TP(b)RATED
 Polycarbonate Diffuser

 SKU: 2744 SKU:2745
 6000K 4500K

3
 Years
 Warranty

LED PANEL PF>0.9
36W With Driver 62x62cm
3600
 Lumens

 IP20

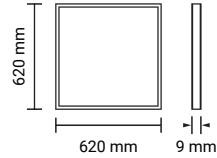
Product code	DL36-A3	Beam Angle	120°
Watts	36W	CRI	Ra>80
Input Voltage	AC : 175-265V	IP Rating	IP20
Flux	3600lm	BOX Qty	1 PCS



 SKU: 2734 SKU:2735 SKU: 2736
 6000K 4500K 2700K

LED BACKLIT PANEL PF>0.9
40W With Driver 60x60cm

IP20

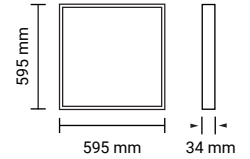

Product code	DL40-A3	Beam Angle	120°
Watts	40W	CRI	Ra>80
Input Voltage	AC : 220-240V	IP Rating	IP20
Flux	3400lm	BOX Qty	10 PCS

 SKU: 2772 SKU:2773
 6000K 4500K

LED PANEL PF>0.9
36W With Driver 62x62cm
3060
 Lumens

 IP20

Product code	DL36-A3	Beam Angle	120°
Watts	36W	CRI	Ra>80
Input Voltage	AC : 175-265V	IP Rating	IP20
Flux	3060lm	BOX Qty	6 PCS

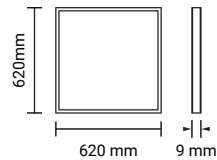

 6 PCS
 BOX

 SKU: 2737 SKU:2738 SKU: 2739
 6000K 4500K 2700K

LED PANEL PF>0.9
45W With Driver 60x60cm
3600
 Lumens

 IP20

Product code	DL45-A5	Beam Angle	120°
Watts	45W	CRI	Ra>80
Input Voltage	AC : 175-265V	IP Rating	IP20
Flux	3600lm	BOX Qty	1 PCS

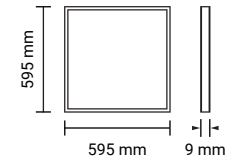

 SKU: 2391 SKU:2392
 6000K 4500K

120
 Lumens/W

LED PANEL PF>0.9
40W With Driver 60x60cm
4800
 Lumens

 IP20

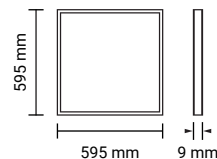
Product code	DL40-A1	Beam Angle	120°
Watts	40W	CRI	Ra>80
Input Voltage	AC : 175-265V	IP Rating	IP20
Flux	4800lm	BOX Qty	1 PCS



 SKU: 2726 SKU:2727 SKU: 2728
 6000K 4500K 2700K

5
 Years
 Warranty

LED PANEL PF>0.9
45W With Driver 60x60cm
4500
 Lumens

 IP20

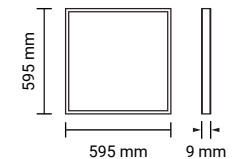
Product code	DL45-A1	Beam Angle	120°
Watts	45W	CRI	Ra>80
Input Voltage	AC : 175-265V	IP Rating	IP20
Flux	4500lm	BOX Qty	6 PCS

 SKU: 2372 SKU:2373 SKU: 2374
 6000K 4500K 2700K

 6 PCS
 BOX

LED PANEL PF>0.9
45W With Driver 60x60cm

Product code	DL45-A5	Beam Angle	120°
Watts	45W	CRI	Ra>80
Input Voltage	AC : 175-265V	IP Rating	IP20
Flux	3600lm	BOX Qty	6 PCS

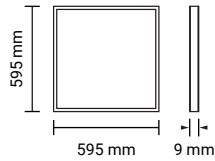
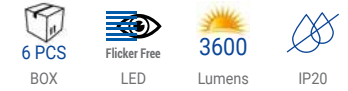

SKU: 2394 SKU:2395 SKU: 2396
 6000K 4500K 2700K

LED PANEL PF>0.9
45W With Driver 62x62cm

Product code	DL45-A5	Beam Angle	120°
Watts	45W	CRI	Ra>95
Input Voltage	AC : 175-265V	IP Rating	IP20
Flux	3600lm	BOX Qty	6 PCS

SKU: 2797 SKU:2798 SKU: 2799
 6000K 4500K 2700K

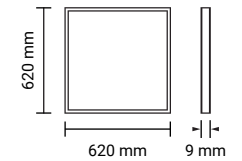
LED PANEL PF>0.9
45W With Driver 60x60cm

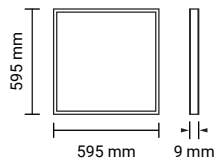

Product code	DL45-A5	Beam Angle	120°
Watts	45W	CRI	Ra>95
Input Voltage	AC : 175-265V	IP Rating	IP20
Flux	3600lm	BOX Qty	6 PCS

SKU: 2397 SKU:2398 SKU: 2399
 6000K 4500K 2700K

LED PANEL Single Pack PF>0.9
45W With Driver 62x62cm

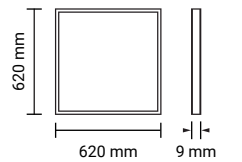

Product code	DL45-A4	Beam Angle	120°
Watts	45W	CRI	Ra>80
Input Voltage	AC : 220-240V	IP Rating	IP20
Flux	3600lm	BOX Qty	1 PCS

SKU: 2791 SKU:2792 SKU: 2793
 6000K 4500K 2700K

LED PANEL Single Pack PF>0.9
45W With Driver 62x62cm

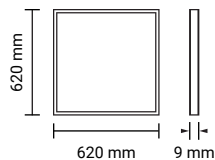

Product code	DL45-A5	Beam Angle	120°
Watts	45W	CRI	Ra>80
Input Voltage	AC : 175-265V	IP Rating	IP20
Flux	3600lm	BOX Qty	1 PCS

SKU: 2788 SKU:2789 SKU: 2790
 6000K 4500K 2700K

LED PANEL PF>0.9
45W With Driver 62x62cm

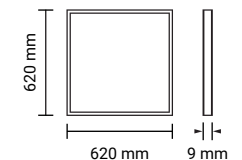

Product code	DL45-A4	Beam Angle	120°
Watts	45W	CRI	Ra>80
Input Voltage	AC : 175-265V	IP Rating	IP20
Flux	3600lm	BOX Qty	6 PCS

SKU: 2794 SKU:2795 SKU: 2796
 6000K 4500K 2700K

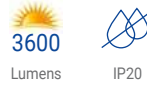

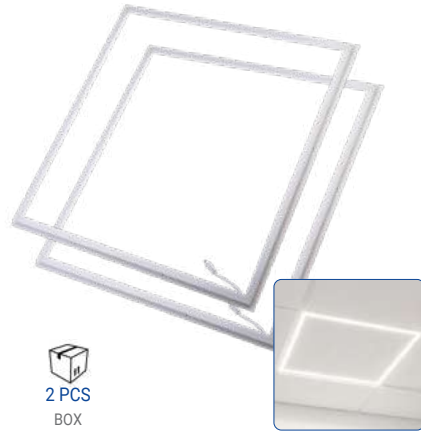
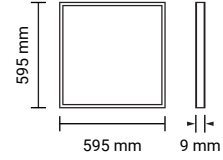

LED FRAME PANEL PF>0.9
36W With Driver 60x60cm

Product code	DL36-A4	Beam Angle	120°
Watts	36W	CRI	Ra>80
Input Voltage	AC : 220-240V	IP Rating	IP20
Flux	3600lm	BOX Qty	2 PCS

 SKU: 2746
 ■ 6000K

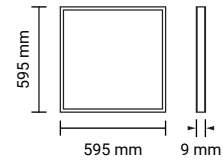
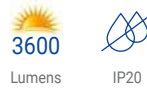
LED FRAME PANEL PF>0.9
45W With Driver 60x60cm

Product code	DL45-A2	Beam Angle	120°
Watts	45W	CRI	Ra>80
Input Voltage	AC : 220-240V	IP Rating	IP20
Flux	3600lm	BOX Qty	2 PCS

 SKU: 2781 SKU:2782
 ■ 6000K ■ 4500K

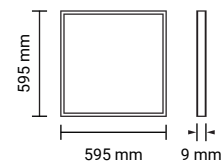
LED PANEL CLOUD OPTIC
45W With Driver 60x60cm

Product code	DL45-A3	Beam Angle	120°
Watts	45W	CRI	Ra>80
Input Voltage	AC : 220-240V	IP Rating	IP20
Flux	3600lm	BOX Qty	4 PCS

 SKU: 2780
 ■ 6000K

LED Panels are flat, their extremely thin profile is only made possible through the use of compact LEDs. The main advantage here is that the lamp itself – both modern and minimalist – takes a back seat, creating a tidier interior aesthetic. Because the light takes up very little space, it helps to make the room appear larger. As a result, LED panels work well even in the smallest of rooms.

LED PANEL PF>0.9
36W With Driver 120x30cm

Product code	DL36-A1	Beam Angle	120°
Watts	36W	CRI	Ra>80
Input Voltage	AC : 220-240V	IP Rating	IP20
Flux	3600lm	BOX Qty	6 PCS

SKU: 2714	SKU: 2715	SKU: 2716
6000K	4500K	2700K

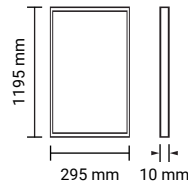
DRIVERS FOR LED PANELS
Dimmable

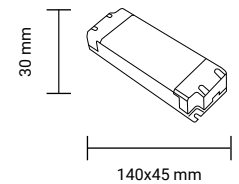

SKU: 6031	600mA	30-42V	25W
SKU: 6032	900mA	30-42V	36W
SKU: 6028	1000mA	30-45V	45W

Watts	25W	36W	45W
Input Voltage	AC: 180-265V	AC: 180-265V	AC: 180-265V
Output Voltage	DC: 30-42V	DC: 30-42V	DC: 30-45V
Material	Plastic	Plastic	Plastic
IP Rating	IP20	IP20	IP20
Product code	AC1-A7	AC1-A8	AC1-A6

LED SLIM PANEL Single Pack PF>0.9
36W With Driver 120x30cm

Product code	DL36-A1	Beam Angle	120°
Watts	36W	CRI	Ra>80
Input Voltage	AC : 220-240V	IP Rating	IP20
Flux	3600lm	BOX Qty	1 PCS

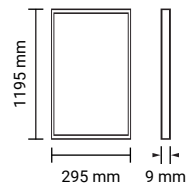
SKU: 2731	SKU: 2732	SKU: 2733
6000K	4500K	2700K

EMERGENCY BATTERY PACK
FOR LED PANELS

Product code	AC1-A9
Battery	3.6V / 4.5Ah
Material	Plastic
Dimension	213x95x40mm
Emergency duration	3 Hours
Dimensional	213x95x45mm

SKU: 6029 Battery Pack

LED DALI DRIVER - Adjustable
FOR LED PANELS

Watts	20-40W
Input Voltage	AC: 220-240V
Output Current	550mA-1050mA
Output Voltage	25V-42V
Material	Plastic
Dimensional	106x70x45mm

Emergency duration 3 Hours

SKU: 6030 20W-40W

LED PANEL PF>0.9
45W With Driver 120x30cm

Product code	DL45-A1	Beam Angle	120°
Watts	45W	CRI	Ra>80
Input Voltage	AC : 220-240V	IP Rating	IP20
Flux	4500lm	BOX Qty	1 and 6 PCS

SKU: 2385	SKU: 2386	SKU: 2387
6000K	4500K	2700K

SKU: 2375	SKU: 2376	SKU: 2377
6000K	4500K	2700K

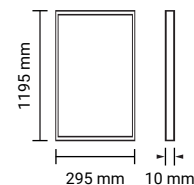



DRIVERS FOR LED PANELS

Plastic Case

SKU: 6019	900mA	36W
SKU: 6021	950mA	45W
SKU: 6022	750mA	48W

Watts	36W	45W	48W
Input Voltage	AC: 175-240V	AC: 175-240V	AC: 175-240V
Output Current	900mA	950mA	750mA
Material	Plastic	Plastic	Plastic
IP Rating	IP20	IP20	IP20

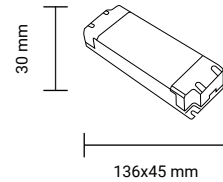

Accessories for Hanging

**Stainless Steel Rope**

SKU: 5182

**Clips for LED Panels**

SKU: 5188



DRIVERS FOR LED DOWNLIGHTS

Plastic Case

SKU: 6035	3-12V	3W
SKU: 6036	15-24V	6W
SKU: 6037	20-40V	12W
SKU: 6038	40-60V	18W
SKU: 6039	60-80V	24W

Watts	3W	6W	12W	18W	24W
Input Voltage	AC: 85-265V	AC: 85-265V	AC: 85-265V	AC: 85-265V	AC: 85-265V
Output Voltage	DC: 3-12V	DC: 15-24V	DC: 20-40V	DC: 40-60V	DC: 60-80V
Material	Plastic	Plastic	Plastic	Plastic	Plastic
IP Rating	IP20	IP20	IP20	IP20	IP20

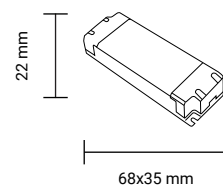

FRAMES FOR LED PANELS

SKU: 5198	Dimension	600x600mm
SKU: 5197	Dimension	300x1200mm





These LED mini panel lights are suitable for recessed installation in offices, hospitals, schools. Easy and quick mounting, there is no need of maintenance, offering long lifetime up of 25 000h

Features:

- Up to 80% power saving
- Different sizes to fit old installations or new lighting projects
- Build-in

Application:

- Home or office use
- Accent lights for shops or stores

LED RECESSED PANELS



LED RECESSED PANELS



180°

NON-Dimmable

IP54

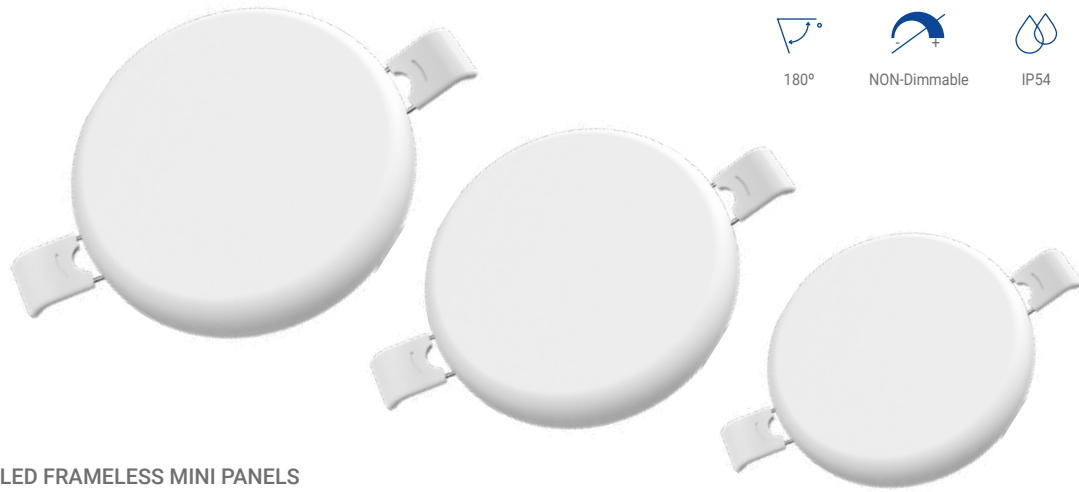

LED FRAMELESS MINI PANELS

ROUND

9W

760

Lumens

Product code	DL9-B2	Beam Angle	180°
Watts	9W	CRI	Ra>80
Input Voltage	AC : 85-265V	IP Rating	IP54
Flux	760lm	Cutting Size	ø75mm

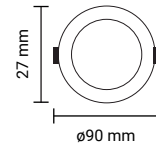
 SKU: 2666
 6000K
18W

1500

Lumens

Product code	DL18-B2	Beam Angle	180°
Watts	18W	CRI	Ra>80
Input Voltage	AC : 85-265V	IP Rating	IP54
Flux	1500lm	Cutting Size	ø108mm

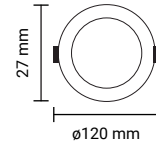
 SKU: 2669 SKU: 2670 SKU: 2671
 6000K 4500K 2700K
24W

2010

Lumens

Product code	DL24-B2	Beam Angle	180°
Watts	24W	CRI	Ra>80
Input Voltage	AC : 85-265V	IP Rating	IP54
Flux	2010lm	Cutting Size	ø155mm

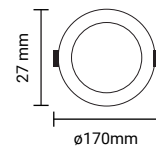
 SKU: 2672 SKU: 2673 SKU: 2674
 6000K 4500K 2700K
36W

3020

Lumens

Product code	DL36-B3	Beam Angle	180°
Watts	36W	CRI	Ra>80
Input Voltage	AC : 85-265V	IP Rating	IP54
Flux	3020lm	Cutting Size	ø206mm

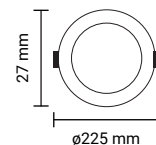
 SKU: 2675 SKU: 2676 SKU: 2677
 6000K 4500K 2700K

180°

NON-Dimmable

IP54

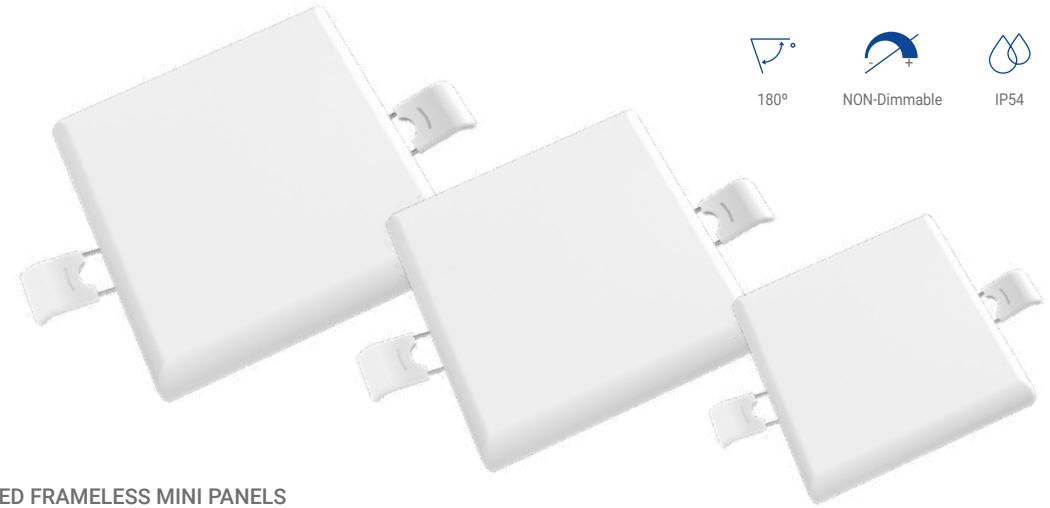

LED FRAMELESS MINI PANELS

SQUARE

9W

760

Lumens

Product code	DL9-B2	Beam Angle	180°
Watts	9W	CRI	Ra>80
Input Voltage	AC : 85-265V	IP Rating	IP54
Flux	760lm	Cutting Size	75x75mm

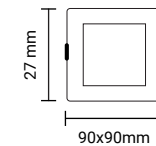

 SKU: 2678
 6000K

 SKU: 2680
 2700K
18W

1500

Lumens

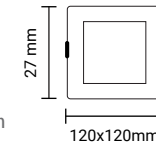
Product code	DL18-B2	Beam Angle	180°
Watts	18W	CRI	Ra>80
Input Voltage	AC : 85-265V	IP Rating	IP54
Flux	1500lm	Cutting Size	108x108mm

 SKU: 2681 SKU: 2682 SKU: 2683
 6000K 4500K 2700K
24W

2010

Lumens

Product code	DL24-B2	Beam Angle	180°
Watts	24W	CRI	Ra>80
Input Voltage	AC : 85-265V	IP Rating	IP54
Flux	2010lm	Cutting Size	155x155mm

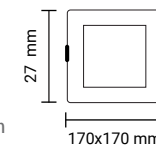
 SKU: 2684 SKU: 2686
 6000K 2700K
36W

3020

Lumens

Product code	DL36-B3	Beam Angle	180°
Watts	36W	CRI	Ra>80
Input Voltage	AC : 85-265V	IP Rating	IP54
Flux	3020lm	Cutting Size	206x206mm

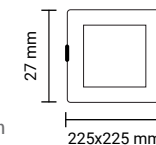
 SKU: 2687 SKU: 2688 SKU: 2689
 6000K 4500K 2700K

LED MINI PANELS
ROUND - Pro Line
TRUE COLOURS SERIES
6W**440**

Lumens

Product code	DL6-B3	Beam Angle	120°
Watts	6W	CRI	Ra>95
Input Voltage	AC : 85-265V	IP Rating	IP20
Flux	440lm	Cutting Size	ø100mm

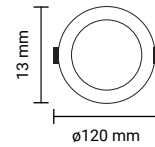
 SKU: 2601 SKU: 2602 SKU: 2603
 6000K 4500K 2700K
12W**1000**

Lumens

Product code	DL12-B3	Beam Angle	120°
Watts	12W	CRI	Ra>95
Input Voltage	AC : 85-265V	IP Rating	IP20
Flux	1000lm	Cutting Size	ø150mm

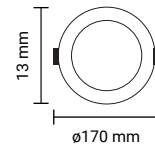
 SKU: 2604 SKU: 2605 SKU: 2606
 6000K 4500K 2700K
18W**1500**

Lumens

Product code	DL18-B3	Beam Angle	120°
Watts	18W	CRI	Ra>95
Input Voltage	AC : 85-265V	IP Rating	IP20
Flux	1500lm	Cutting Size	ø200mm

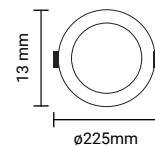
 SKU: 2608 SKU: 2609 SKU: 2610
 6000K 4500K 2700K
24W**2010**

Lumens

Product code	DL24-B3	Beam Angle	120°
Watts	24W	CRI	Ra>95
Input Voltage	AC : 85-265V	IP Rating	IP20
Flux	2010lm	Cutting Size	ø270mm

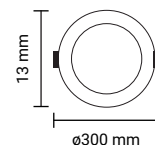
 SKU: 2611 SKU: 2612 SKU: 2613
 6000K 4500K 2700K

LED MINI PANELS
SQUARE - Pro Line
TRUE COLOURS SERIES
6W**440**

Lumens

Product code	DL6-B3	Beam Angle	120°
Watts	6W	CRI	Ra>95
Input Voltage	AC : 85-265V	IP Rating	IP20
Flux	440lm	Cutting Size	95x95mm

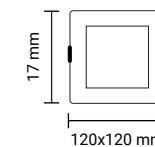
 SKU: 2614 SKU: 2615 SKU: 2616
 6000K 4500K 2700K
12W**1000**

Lumens

Product code	DL12-B3	Beam Angle	120°
Watts	12W	CRI	Ra>95
Input Voltage	AC : 85-265V	IP Rating	IP20
Flux	1000lm	Cutting Size	150x150mm

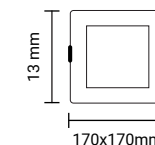
 SKU: 2617 SKU: 2618 SKU: 2619
 6000K 4500K 2700K
18W**1500**

Lumens

Product code	DL18-B3	Beam Angle	120°
Watts	18W	CRI	Ra>95
Input Voltage	AC : 85-265V	IP Rating	IP20
Flux	1500lm	Cutting Size	200x200mm

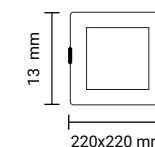
 SKU: 2630 SKU: 2631 SKU: 2632
 6000K 4500K 2700K
24W**2010**

Lumens

Product code	DL24-B3	Beam Angle	120°
Watts	24W	CRI	Ra>95
Input Voltage	AC : 85-265V	IP Rating	IP20
Flux	2010lm	Cutting Size	270x270mm

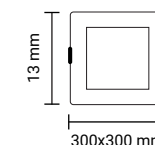
 SKU: 2642 SKU: 2643 SKU: 2644
 6000K 4500K 2700K



LED MINI PANELS
ROUND - Home Edition

3W 150 Lumens	Product code DL3-B1 Watts 3W Input Voltage AC : 85-260V Flux 150lm	Beam Angle 120° CRI Ra>80 IP Rating IP20 Cutting Size ø62mm
----------------------------	---	--

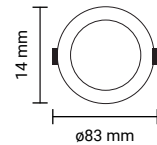

SKU: 2470 6000K
SKU: 2471 4500K
SKU: 2472 2800K

6W 360 Lumens	Product code DL6-B1 Watts 6W Input Voltage AC : 85-260V Flux 360lm	Beam Angle 120° CRI Ra>80 IP Rating IP20 Cutting Size ø99mm
----------------------------	---	--

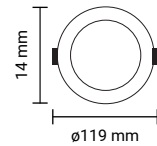

SKU: 2473 6000K
SKU: 2474 4500K
SKU: 2475 2800K

12W 840 Lumens	Product code DL12-B1 Watts 12W Input Voltage AC : 85-260V Flux 840lm	Beam Angle 120° CRI Ra>80 IP Rating IP20 Cutting Size ø146mm
-----------------------------	---	---

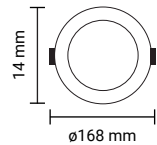

SKU: 2476 6000K
SKU: 2477 4500K
SKU: 2478 2800K

18W 1350 Lumens	Product code DL18-B1 Watts 18W Input Voltage AC : 85-260V Flux 1350lm	Beam Angle 120° CRI Ra>80 IP Rating IP20 Cutting Size ø196mm
------------------------------	--	---

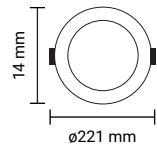

SKU: 2479 6000K
SKU: 2480 4500K
SKU: 2481 2800K

24W 1700 Lumens	Product code DL24-B1 Watts 24W Input Voltage AC : 85-260V Flux 1700lm	Beam Angle 120° CRI Ra>80 IP Rating IP20 Cutting Size ø276mm
------------------------------	--	---

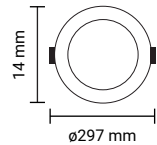

SKU: 2482 6000K
SKU: 2483 4500K
SKU: 2484 2800K



LED MINI PANELS
SQUARE - Home Edition

3W 150 Lumens	Product code DL3-B1 Watts 3W Input Voltage AC : 85-260V Flux 150lm	Beam Angle 120° CRI Ra>80 IP Rating IP20 Cutting Size 67x67mm
----------------------------	---	--

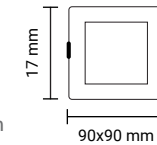

SKU: 2485 6000K
SKU: 2486 4500K
SKU: 2487 2800K

6W 360 Lumens	Product code DL6-B1 Watts 6W Input Voltage AC : 85-260V Flux 360lm	Beam Angle 120° CRI Ra>80 IP Rating IP20 Cutting Size 98x98mm
----------------------------	---	--

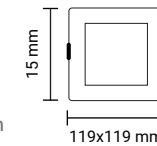

SKU: 2488 6000K
SKU: 2489 4500K
SKU: 2490 2800K

12W 840 Lumens	Product code DL12-B1 Watts 12W Input Voltage AC : 85-260V Flux 840lm	Beam Angle 120° CRI Ra>80 IP Rating IP20 Cutting Size 148x148mm
-----------------------------	---	--

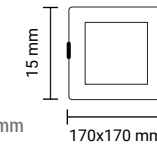

SKU: 2491 6000K
SKU: 2492 4500K
SKU: 2493 2800K

18W 1350 Lumens	Product code DL18-B1 Watts 18W Input Voltage AC : 85-260V Flux 1350lm	Beam Angle 120° CRI Ra>80 IP Rating IP20 Cutting Size 198x198mm
------------------------------	--	--

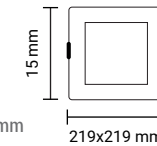

SKU: 2494 6000K
SKU: 2496 4500K
SKU: 2495 2800K

24W 1700 Lumens	Product code DL24-B1 Watts 24W Input Voltage AC : 85-260V Flux 1700lm	Beam Angle 120° CRI Ra>80 IP Rating IP20 Cutting Size 270x270mm
------------------------------	--	--

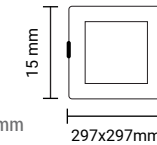

SKU: 2497 6000K
SKU: 2498 4500K
SKU: 2499 2800K

CCT - LED MINI PANELS
ROUND Build-in Driver
6W450
Lumens

Product code	DL6-A6	Beam Angle	100°
Watts	6W	CRI	Ra>80
Input Voltage	AC : 165-265V	IP Rating	IP44 Front
Flux	450lm	Cutting Size	ø105mm

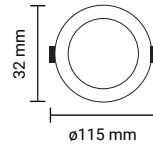

SKU: 2590

CCT Steps

6000K 4500K 3000K

CCT - LED MINI PANELS
SQUARE Build-in Driver
6W450
Lumens

Product code	DL6-A6	Beam Angle	100°
Watts	6W	CRI	Ra>80
Input Voltage	AC : 165-265V	IP Rating	IP44 Front
Flux	450lm	Cutting Size	105x105mm

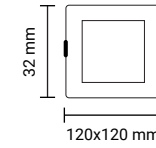

SKU: 2594

CCT Steps

6000K 4500K 3000K

12W950
Lumens

Product code	DL12-A6	Beam Angle	100°
Watts	12W	CRI	Ra>80
Input Voltage	AC : 165-265V	IP Rating	IP44 Front
Flux	950lm	Cutting Size	ø155mm

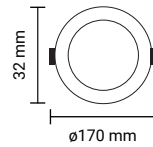

SKU: 2591

CCT Steps

6000K 4500K 3000K

12W950
Lumens

Product code	DL12-A6	Beam Angle	100°
Watts	12W	CRI	Ra>80
Input Voltage	AC : 165-265V	IP Rating	IP44 Front
Flux	950lm	Cutting Size	155x155mm

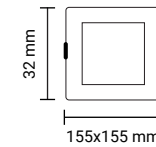

SKU: 2595

CCT Steps

6000K 4500K 3000K

18W1880
Lumens

Product code	DL18-A6	Beam Angle	100°
Watts	18W	CRI	Ra>80
Input Voltage	AC : 165-265V	IP Rating	IP44 Front
Flux	1880lm	Cutting Size	ø205mm

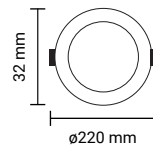

SKU: 2592

CCT Steps

6000K 4500K 3000K

18W1450
Lumens

Product code	DL18-A6	Beam Angle	100°
Watts	18W	CRI	Ra>80
Input Voltage	AC : 165-265V	IP Rating	IP44 Front
Flux	1450lm	Cutting Size	205x205mm

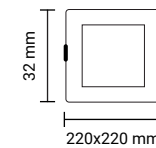

SKU: 2596

CCT Steps

6000K 4500K 3000K

24W2150
Lumens

Product code	DL24-A6	Beam Angle	100°
Watts	24W	CRI	Ra>80
Input Voltage	AC : 165-265V	IP Rating	IP44 Front
Flux	2150lm	Cutting Size	ø225mm

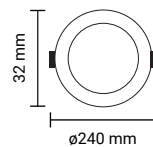

SKU: 2593

CCT Steps

6000K 4500K 3000K

24W2150
Lumens

Product code	DL24-A6	Beam Angle	100°
Watts	24W	CRI	Ra>80
Input Voltage	AC : 165-265V	IP Rating	IP44 Front
Flux	2150lm	Cutting Size	205x205mm

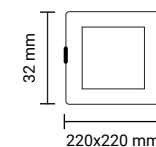

SKU: 2597

CCT Steps

6000K 4500K 3000K



LED MINI PANELS

ROUND

3W**150**

Lumens

Product code	DL3-A4	Beam Angle	120°
Watts	3W	CRI	Ra>80
Input Voltage	AC : 85-260V	IP Rating	IP20
Flux	150lm	Cutting Size	ø80mm

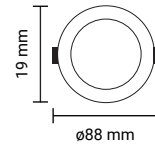
 SKU: 2431  6000K
 SKU: 2432  4500K
 SKU: 2433  2700K
6W**360**

Lumens

Product code	DL6-A4	Beam Angle	120°
Watts	6W	CRI	Ra>80
Input Voltage	AC : 85-260V	IP Rating	IP20
Flux	360lm	Cutting Size	ø110mm

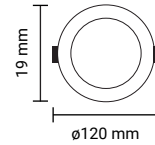
 SKU: 2434  6000K
 SKU: 2435  4500K
 SKU: 2436  2700K
12W**840**

Lumens

Product code	DL12-A4	Beam Angle	120°
Watts	12W	CRI	Ra>80
Input Voltage	AC : 85-260V	IP Rating	IP20
Flux	840lm	Cutting Size	ø155mm

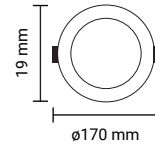
 SKU: 2437  6000K
 SKU: 2438  4500K
 SKU: 2439  2700K
18W**1350**

Lumens

Product code	DL18-A4	Beam Angle	120°
Watts	18W	CRI	Ra>80
Input Voltage	AC : 85-260V	IP Rating	IP20
Flux	1350lm	Cutting Size	ø205mm

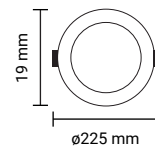
 SKU: 2335  6000K
 SKU: 2440  4500K
 SKU: 2336  2700K
24W**1700**

Lumens

Product code	DL24-A4	Beam Angle	120°
Watts	24W	CRI	Ra>80
Input Voltage	AC : 85-260V	IP Rating	IP20
Flux	1700lm	Cutting Size	ø285mm

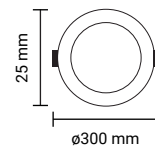
 SKU: 2441  6000K
 SKU: 2442  4500K
 SKU: 2443  2700K



LED MINI PANELS

SQUARE

3W**150**

Lumens

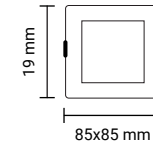
Product code	DL3-A4	Beam Angle	120°
Watts	3W	CRI	Ra>80
Input Voltage	AC : 85-260V	IP Rating	IP20
Flux	150lm	Cutting Size	75x75mm

 SKU: 2444  6000K
 SKU: 2445  4500K
 SKU: 2446  2700K
6W**360**

Lumens

Product code	DL6-A4	Beam Angle	120°
Watts	6W	CRI	Ra>80
Input Voltage	AC : 85-260V	IP Rating	IP20
Flux	360lm	Cutting Size	110x110mm

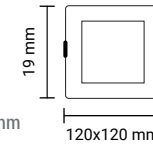
 SKU: 2447  6000K
 SKU: 2448  4500K
 SKU: 2449  2700K
12W**840**

Lumens

Product code	DL12-A4	Beam Angle	120°
Watts	12W	CRI	Ra>80
Input Voltage	AC : 85-260V	IP Rating	IP20
Flux	840lm	Cutting Size	155x155mm

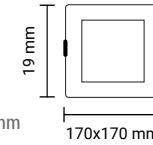
 SKU: 2450  6000K
 SKU: 2451  4500K
 SKU: 2452  2700K
18W**1350**

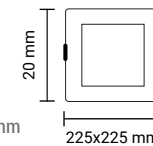

Lumens

Product code	DL18-A4	Beam Angle	120°
Watts	18W	CRI	Ra>80
Input Voltage	AC : 85-260V	IP Rating	IP20
Flux	1350lm	Cutting Size	205x205mm

 SKU: 2348  6000K
 SKU: 2453  4500K
 SKU: 2349  2700K
24W**1700**

Lumens

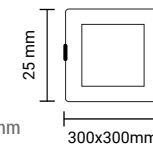
Product code	DL24-A4	Beam Angle	120°
Watts	24W	CRI	Ra>80
Input Voltage	AC : 85-260V	IP Rating	IP20
Flux	1700lm	Cutting Size	282x282mm

 SKU: 2454  6000K
 SKU: 2455  4500K
 SKU: 2456  2700K

3 Years
Warranty

120°

Dimmable

IP44



Color Changing Knob



CCT - LED MINI PANELS

ROUND Build-in Driver - Dimmable

6W

450
Lumens

Product code	DL6-A7	Beam Angle	100°
Watts	6W	CRI	Ra>80
Input Voltage	AC : 220-240V	IP Rating	IP44 Front
Flux	450lm	Cutting Size	ø105mm

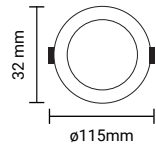

SKU: 2581

CCT Steps

6000K 4500K 3000K

9W

650
Lumens

Product code	DL9-A7	Beam Angle	100°
Watts	9W	CRI	Ra>80
Input Voltage	AC : 220-240V	IP Rating	IP44 Front
Flux	650lm	Cutting Size	ø105mm

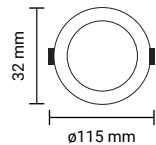

SKU: 2582

CCT Steps

6000K 4500K 3000K

12W

900
Lumens

Product code	DL16-A7	Beam Angle	100°
Watts	12W	CRI	Ra>80
Input Voltage	AC : 220-240V	IP Rating	IP44 Front
Flux	900lm	Cutting Size	ø155mm

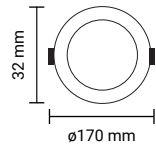

SKU: 2583

CCT Steps

6000K 4500K 3000K

20W

1600
Lumens

Product code	DL20-A7	Beam Angle	100°
Watts	20W	CRI	Ra>80
Input Voltage	AC : 220-240V	IP Rating	IP44 Front
Flux	1600lm	Cutting Size	ø205mm

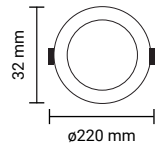

SKU: 2584

CCT Steps

6000K 4500K 3000K

24W

2100
Lumens

Product code	DL24-A7	Beam Angle	100°
Watts	24W	CRI	Ra>80
Input Voltage	AC : 220-240V	IP Rating	IP44 Front
Flux	2100lm	Cutting Size	ø225mm

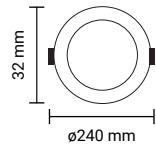

SKU: 2585

CCT Steps

6000K 4500K 3000K



Downlight Adapter

ROUND Build-in Driver - Dimmable

SKU: 5003

Surface 3'D105 from 6-9W
Compatible with SKU: 2581, 2582

SKU: 5004

Surface 3'D105 from 12-16W
Compatible with SKU: 2583

SKU: 5005

Surface 7'D205 from 18-20W
Compatible with SKU: 2584

SKU: 5006

Surface 8'D225 from 22-24W
Compatible with SKU: 2585



Mini Panels Dimmable Drivers



Dimmable



IP20



SKU: 6025

Dimmable Driver 220V 5-9*1W 300mA

SKU: 6026

Dimmable Driver 220V 10-18*1W 300mA

SKU: 6027

Dimmable Driver 220V 20-30*1W 300mA



LED SLIM 5 in 1 BUILD-IN/SURFACE
CCT LED 3000 to 6000K

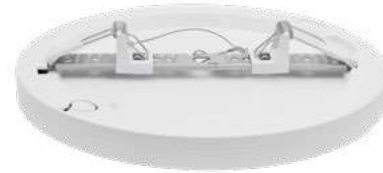

Slidable spring



Color Changing Knob

3 Years Warranty
100° Beam Angle
IP20

18W

1600 Lumens

Product code DL18-A7
Watts 18W
Input Voltage AC : 175-265V
Flux 1600lm
Beam Angle 100°
CRI Ra>80
IP Rating IP20
Cutting Size ø65-210mm

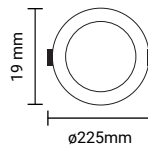

SKU: 2586
CCT Steps
6000K 4500K 3000K

30W

3000 Lumens

Product code DL30-A7
Watts 30W
Input Voltage AC : 175-265V
Flux 3000lm
Beam Angle 100°
CRI Ra>80
IP Rating IP20
Cutting Size ø65-310mm

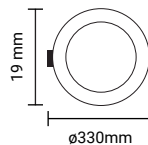

SKU: 2587
CCT Steps
6000K 4500K 3000K

NEW PRODUCT



LED CABINET LIGHT
1W Round - Black Body

Watts 1W
Input Voltage AC : 220-240V
Flux 60lm
Beam Angle 28°
CRI Ra>80
IP Rating IP20

SKU: 3296
3000K

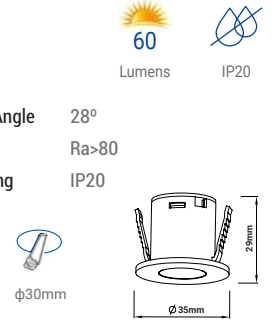

NEW PRODUCT



LED CABINET LIGHT
1W Round - White Body

Watts 1W
Input Voltage AC : 220-240V
Flux 60lm
Beam Angle 28°
CRI Ra>80
IP Rating IP20

SKU: 3297
3000K

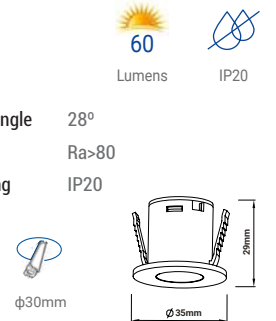

NEW PRODUCT



LED CABINET LIGHT
1W Square - Black Body

Watts 1W
Input Voltage AC : 220-240V
Flux 60lm
Beam Angle 28°
CRI Ra>80
IP Rating IP20

SKU: 3298
3000K

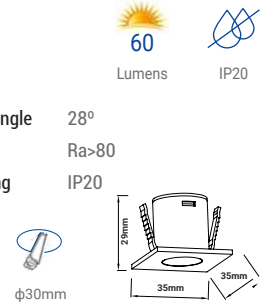

NEW PRODUCT



LED CABINET LIGHT
1W Square - White Body

Watts 1W
Input Voltage AC : 220-240V
Flux 60lm
Beam Angle 28°
CRI Ra>80
IP Rating IP20

SKU: 3299
3000K

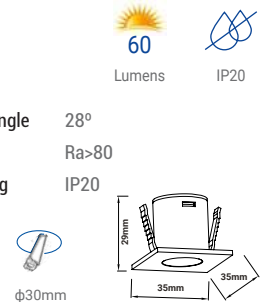



LED downlights offer a wide variety of applications, from home use as additional lights, to main or accent lighting. Applicable in homes, offices and stores.

Features:

- Up to 80% power saving
- Different sizes to fit old installations or new lighting projects
- Variety of IP ratings
- Fixed or rotatable
- Fire-rated models
- Build-in or surface installation

Application:

- Home or office use
- Accent lights for shops or stores
- Suitable for suspended ceilings



LED DOWNLIGHTS

LED COB Downlight
5W Adjustable

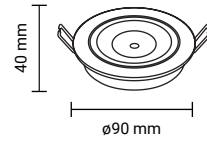
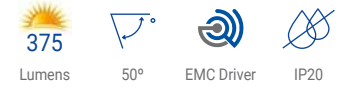

Product code	CB5-A1	CRI	Ra>80
Watts	5W	IP Rating	IP20
Input Voltage	AC : 100-240V	Cutting Size	ø80
Flux	375lm	Body Color	White
Beam Angle	50°	Dimmable	NO

SKU: 3264 SKU:3265 SKU: 3266
 ■ 6000K ■ 4500K ■ 2700K

LED COB Downlight
5W Adjustable

Product code	CB5-A1	CRI	Ra>80
Watts	5W	IP Rating	IP20
Input Voltage	AC : 100-240V	Cutting Size	ø80
Flux	375lm	Body Color	White
Beam Angle	50°	Dimmable	NO

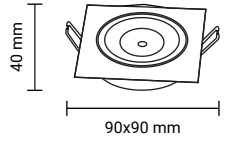
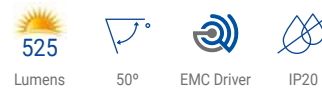
SKU: 3267 SKU:3268 SKU: 3269
 ■ 6000K ■ 4500K ■ 2700K

LED COB Downlight
7W Adjustable

Product code	CB7-A1	CRI	Ra>80
Watts	7W	IP Rating	IP20
Input Voltage	AC : 100-240V	Cutting Size	ø80
Flux	525lm	Body Color	White
Beam Angle	50°	Dimmable	NO

SKU: 3284 SKU:3285 SKU: 3286
 ■ 6000K ■ 4500K ■ 2700K

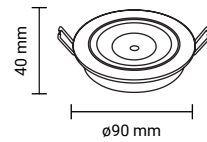
LED COB Downlight
7W Adjustable

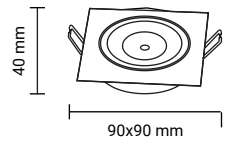

Product code	CB7-A1	CRI	Ra>80
Watts	7W	IP Rating	IP20
Input Voltage	AC : 100-240V	Cutting Size	ø80
Flux	525lm	Body Color	White
Beam Angle	50°	Dimmable	NO

SKU: 3287 SKU:3288 SKU: 3289
 ■ 6000K ■ 4500K ■ 2700K

LED COB Downlight
10W Adjustable

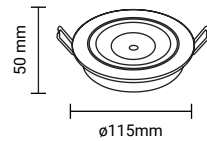

Product code	CB10-A1	CRI	Ra>80
Watts	10W	IP Rating	IP20
Input Voltage	AC : 100-240V	Cutting Size	ø105
Flux	750lm	Body Color	White
Beam Angle	50°	Dimmable	NO

SKU: 3290 SKU:3291 SKU: 3292
 ■ 6000K ■ 4500K ■ 2700K

LED COB Downlight
10W Adjustable

Product code	CB10-A1	CRI	Ra>80
Watts	10W	IP Rating	IP20
Input Voltage	AC : 100-240V	Cutting Size	ø105
Flux	750lm	Body Color	White
Beam Angle	50°	Dimmable	NO

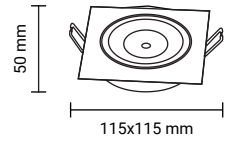
SKU: 3293 SKU:3294 SKU: 3295
 ■ 6000K ■ 4500K ■ 2700K



**LED COB Downlight
8W Adjustable**

Product code	CB8-A1	CRI	Ra>80
Watts	8W	IP Rating	IP20
Input Voltage	AC : 220-265V	Cutting Size	ø80
Flux	560lm	Body Color	White
Beam Angle	60°	Dimmable	NO

SKU: 3201 SKU:3206 SKU: 3202
 ■ 6000K ■ 4500K ■ 2700K

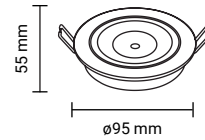
**LED COB Downlight
12W Adjustable**

Product code	CB12-A1	CRI	Ra>80
Watts	12W	IP Rating	IP20
Input Voltage	AC : 200-265V	Cutting Size	ø105
Flux	960lm	Body Color	White
Beam Angle	60°	Dimmable	NO

SKU: 3251
 ■ 6000K

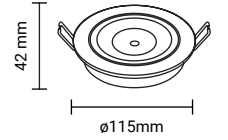
**LED COB Downlight
8W Adjustable**

Product code	CB8-A1	CRI	Ra>80
Watts	8W	IP Rating	IP20
Input Voltage	AC : 220-265V	Cutting Size	ø80
Flux	560lm	Body Color	Inox
Beam Angle	60°	Dimmable	NO

SKU: 3203 SKU:3205 SKU: 3204
 ■ 6000K ■ 4500K ■ 2700K

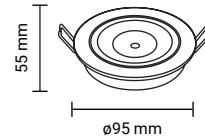
**LED COB Downlight
12W Adjustable**

Product code	CB12-A1	CRI	Ra>80
Watts	12W	IP Rating	IP20
Input Voltage	AC : 220-265V	Cutting Size	ø105
Flux	960lm	Body Color	Inox
Beam Angle	60°	Dimmable	NO

SKU: 3254
 ■ 6000K

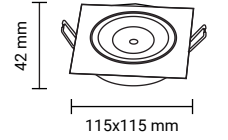
**LED COB Downlight
8W Adjustable**

Product code	CB8-A1	CRI	Ra>80
Watts	8W	IP Rating	IP20
Input Voltage	AC : 220-265V	Cutting Size	ø80
Flux	560lm	Body Color	White
Beam Angle	60°	Dimmable	NO

SKU: 3207 SKU:3222 SKU: 3212
 ■ 6000K ■ 4500K ■ 2700K

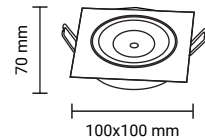
**LED COB Downlight
25W Adjustable**

Product code	CB25-A1	CRI	Ra>80
Watts	25W	IP Rating	IP20
Input Voltage	AC : 220-240V	Cutting Size	ø160
Flux	2200lm	Body Color	White
Beam Angle	60°	Dimmable	NO

SKU: 3241 SKU:3242
 ■ 6000K ■ 4500K

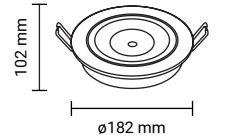
**LED COB Downlight
8W Adjustable**

Product code	CB8-A1	CRI	Ra>80
Watts	8W	IP Rating	IP20
Input Voltage	AC : 220-265V	Cutting Size	ø80
Flux	560lm	Body Color	Inox
Beam Angle	60°	Dimmable	NO

SKU: 3223 SKU:3224 SKU: 3225
 ■ 6000K ■ 4500K ■ 2700K

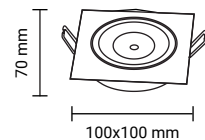
**LED COB Downlight
35W Adjustable**

Product code	CB35-A1	CRI	Ra>80
Watts	35W	IP Rating	IP20
Input Voltage	AC : 220-240V	Cutting Size	ø210
Flux	3000lm	Body Color	Inox
Beam Angle	60°	Dimmable	NO

SKU: 3243
 ■ 6000K

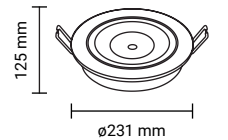

LED COB Downlight
15W - TÜV

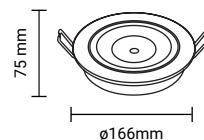

Product code	CB15-A2	CRI	Ra>80
Watts	15W	IP Rating	IP20
Input Voltage	AC : 220-240V	Cutting Size	ø155
Flux	1200lm	Body Color	White
Beam Angle	145°	Dimmable	NO

SKU: 3270 SKU:3271 SKU: 3272
 ■ 6000K ■ 4500K ■ 2700K

LED COB Downlight
20W - TÜV

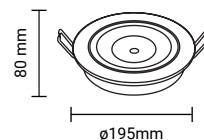

Product code	CB20-A2	CRI	Ra>80
Watts	20W	IP Rating	IP20
Input Voltage	AC : 220-240V	Cutting Size	ø165
Flux	1600lm	Body Color	White
Beam Angle	145°	Dimmable	NO

SKU: 3273 SKU:3274 SKU: 3275
 ■ 6000K ■ 4500K ■ 2700K

LED COB Downlight
30W - TÜV

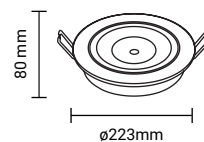

Product code	CB30-A2	CRI	Ra>80
Watts	30W	IP Rating	IP20
Input Voltage	AC : 220-240V	Cutting Size	ø195
Flux	2500lm	Body Color	White
Beam Angle	145°	Dimmable	NO

SKU: 3276 SKU:3277 SKU: 3278
 ■ 6000K ■ 4500K ■ 2700K

LED COB Downlight
40W - TÜV

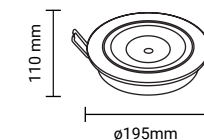

Product code	CB40-A2	CRI	Ra>80
Watts	40W	IP Rating	IP20
Input Voltage	AC : 100-240V	Cutting Size	ø175
Flux	4000lm	Body Color	White
Beam Angle	60°	Dimmable	NO

SKU: 3260 SKU:3261
 ■ 6000K ■ 4500K

LED COB Downlight
60W - TÜV

Product code	CB60-A1	CRI	Ra>80
Watts	60W	IP Rating	IP20
Input Voltage	AC : 100-240V	Cutting Size	ø205
Flux	5600lm	Body Color	White
Beam Angle	60°	Dimmable	NO

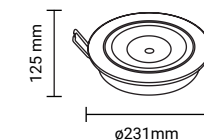
SKU: 3262 SKU:3263
 ■ 6000K ■ 4500K





LED SMD FIRE-RATED PF>0.9
10W - CCT 3000K to 6000K

Product code	OT10-A1	CRI	Ra>80
Watts	10W	IP Rating	IP65
Input Voltage	AC : 200-240V	Cutting Size	ø60
Flux	750lm	Dimension	ø84x67mm
Beam Angle	40°	Dimmable	YES

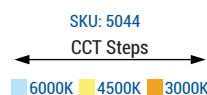

CCT Knob

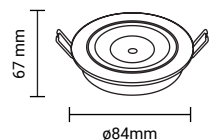

LED SMD FIRE-RATED PF>0.9
6W - Replaceable covers

Product code	OT6-A2	CRI	Ra>80
Watts	6W	IP Rating	IP65
Input Voltage	AC : 200-265V	Cutting Size	ø60
Flux	540lm	Dimension	ø84x67mm
Beam Angle	40°	Dimmable	YES



Magnetic replaceable covers



BEZELS FOR LED FIRE-RATED DOWNLIGHT
Magnetic Bazels

SKU: 5045	CHROME BEZEL
SKU: 5046	BRUSHED BEZEL

MAGNETIC CHROME BEZEL FOR 5044

MAGNETIC BRUSHED BEZEL FOR 5044



SKU: 5045



SKU: 5046



LED SMD FIRE-RATED PF>0.9
8W - CCT 3000K to 6000K

Product code	OT8-A1	CRI	Ra>80
Watts	8W	IP Rating	IP65
Input Voltage	AC : 175-265V	Cutting Size	ø65
Flux	570-630lm	Dimension	ø80x80mm
Beam Angle	40°	Dimmable	YES

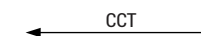

SKU: 5043 3800156650435



CCT Knob



Magnetic replaceable covers

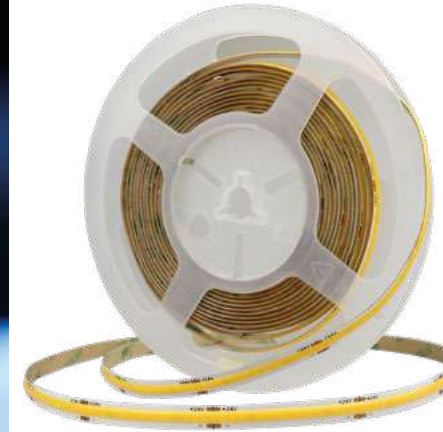

LED Strips are a flexible solution for wide variety of lighting applications, both for indoor and outdoor projects, allowing for variable shapes and abstract forms. Functioning as a core or supplementary lighting, LED strips become a common choice of lighting professionals.

Features:

- Up to 80% power saving
- Flexible and reliable
- Wide choice of colour – single colour light to RGB
- Variety of IP ratings
- Options for dimming and control

Application:

- Indoor and outdoor lighting projects
- Applicable for abstract forms and shapes
- Hidden or ambient light

LED STRIPS AND ACCESSORIES

LED Strip 12V 2835 60 LEDs
4.8W/m - Non Waterproof

Product code	ST2835-A1	LED Qty	60 SMD/m
Type LED	SMD 2835	Material	Flex PCB
Power/Meter	4.8W/m	Beam Angle	120°
Voltage	DC: 12V	IP Rating	IP20
Flux/Meter	300lm/m	Width	8mm

SKU: 4702 SKU:4700 SKU: 4703
 ■ 6000K ■ 4500K ■ 2700K

LED Strip 12V 2835 204 LEDs
16.5W/m - Non Waterproof

Product code	ST2835-A1	LED Qty	204 SMD/m
Type LED	SMD 2835	Material	Flex PCB
Power/Meter	16.5W/m	Beam Angle	120°
Voltage	DC: 12V	IP Rating	IP20
Flux/Meter	1700lm/m	Width	10mm

SKU: 4761 SKU:4762 SKU: 4763
 ■ 6000K ■ 4500K ■ 2700K

LED Strip 12V 2835 60 LEDs
4.8W/m - Non Waterproof

Product code	ST2835-A1	LED Qty	60 SMD/m
Type LED	SMD 2835	Material	Flex PCB
Power/Meter	4.8W/m	Beam Angle	120°
Voltage	DC: 12V	IP Rating	IP20
Flux/Meter	300lm/m	Width	8mm

SKU: 4704 SKU:4706
 ■ RED ■ BLUE

LED Strip 12V 5050 60 LEDs
14.4W/m - Non Waterproof

Product code	ST5050-A1	LED Qty	60 SMD/m
Type LED	SMD 5050	Material	Flex PCB
Power/Meter	14.4W/m	Beam Angle	120°
Voltage	DC: 12V	IP Rating	IP20
Flux/Meter	1000lm/m	Width	12mm

SKU: 4313
 ■ + ■ RGB+6000K

LED Strip 12V 2835 120 LEDs
9.6W/m - Non Waterproof

Product code	ST2835-A1	LED Qty	120 SMD/m
Type LED	SMD 2835	Material	Flex PCB
Power/Meter	9.6W/m	Beam Angle	120°
Voltage	DC: 12V	IP Rating	IP20
Flux/Meter	600lm/m	Width	8mm

SKU: 4710 SKU:4740 SKU: 4711
 ■ 6000K ■ 4500K ■ 2700K

LED Strip 12V 5050 60 LEDs
14.4W/m - Non Waterproof

Product code	ST5050-A1	LED Qty	60 SMD/m
Type LED	SMD 5050	Material	Flex PCB
Power/Meter	14.4W/m	Beam Angle	120°
Voltage	DC: 12V	IP Rating	IP20
Flux/Meter	1000lm/m	Width	12mm

SKU: 4314
 ■ + ■ RGB+3000K



LED Strip 12V 2835 60 LEDs
4.8W/m - Waterproof

Product code	ST2835-A2	LED Qty	60 SMD/m
Type LED	SMD 2835	Material	Flex PCB
Power/Meter	4.8W/m	Beam Angle	120°
Voltage	DC: 12V	IP Rating	IP54
Flux/Meter	300lm/m	Width	8mm

SKU: 4732 SKU:4731 SKU: 4733
 ■ 6000K ■ 4500K ■ 2700K

LED Strip 12V 2835 60 LEDs
4.8W/m - Waterproof

Product code	ST2835-A2	LED Qty	60 SMD/m
Type LED	SMD 2835	Material	Flex PCB
Power/Meter	4.8W/m	Beam Angle	120°
Voltage	DC: 12V	IP Rating	IP54
Flux/Meter	300lm/m	Width	8mm

SKU: 4734 SKU:4735 SKU: 4736
 ■ RED ■ GREEN ■ BLUE

LED Strip 12V 2835 120 LEDs
9.6W/m - Waterproof

Product code	ST2835-A2	LED Qty	120 SMD/m
Type LED	SMD 2835	Material	Flex PCB
Power/Meter	9.6W/m	Beam Angle	120°
Voltage	DC: 12V	IP Rating	IP54
Flux/Meter	600lm/m	Width	8mm

SKU: 4720 SKU: 4721
 ■ 6000K ■ 2700K

LED Strip 12V 5050 30 LEDs
7.2W/m - Non Waterproof

Product code	ST5050-A1	LED Qty	30 SMD/m
Type LED	SMD 5050	Material	Flex PCB
Power/Meter	7.2W/m	Beam Angle	120°
Voltage	DC: 12V	IP Rating	IP20
Flux/Meter	500lm/m	Width	10mm

SKU: 4801 SKU:4800 SKU: 4802
 ■ 6000K ■ 4500K ■ 2700K

LED Strip 12V 5050 60 LEDs
14.4W/m - Non Waterproof

Product code	ST5050-A1	LED Qty	60 SMD/m
Type LED	SMD 5050	Material	Flex PCB
Power/Meter	14.4W/m	Beam Angle	120°
Voltage	DC: 12V	IP Rating	IP20
Flux/Meter	1000lm/m	Width	10mm

SKU: 4807 SKU:4827 SKU: 4808
 ■ 6000K ■ 4500K ■ 2700K

LED Strip 12V 5050 60 LEDs
14.4W/m - Non Waterproof

Product code	ST5050-A1	LED Qty	60 SMD/m
Type LED	SMD 5050	Material	Flex PCB
Power/Meter	14.4W/m	Beam Angle	120°
Voltage	DC: 12V	IP Rating	IP20
Flux/Meter	1000lm/m	Width	10mm

SKU: 4823 SKU:4825
 ■ RED ■ BLUE



LED Strip 12V 5050 30 LEDs
7.2W/m - Waterproof

Product code	ST5050-A2	LED Qty	30 SMD/m
Type LED	SMD 5050	Material	Flex PCB
Power/Meter	7.2W/m	Beam Angle	120°
Voltage	DC: 12V	IP Rating	IP54
Flux/Meter	500lm/m	Width	10mm

SKU: 4809 SKU:4811 SKU: 4810
 6000K 4500K 2700K

LED Strip 12V 5050 60 LEDs
14.4W/m - Waterproof

Product code	ST5050-A2	LED Qty	60 SMD/m
Type LED	SMD 5050	Material	Flex PCB
Power/Meter	14.4W/m	Beam Angle	120°
Voltage	DC: 12V	IP Rating	IP54
Flux/Meter	1000lm/m	Width	10mm

SKU: 4839 SKU:4841 SKU: 4840
 6000K 4500K 2700K

LED Strip 12V 5050 60 LEDs
14.4W/m - Waterproof

Product code	ST5050-A2	LED Qty	60 SMD/m
Type LED	SMD 5050	Material	Flex PCB
Power/Meter	14.4W/m	Beam Angle	120°
Voltage	DC: 12V	IP Rating	IP54
Flux/Meter	1000lm/m	Width	10mm

SKU: 4842 SKU:4843
 RED BLUE

LED Strip 12V 5050 30 LEDs
7.2W/m

Product code	ST5050-A1	LED Qty	30 SMD/m
Type LED	SMD 5050	Material	Flex PCB
Power/Meter	7.2W/m	Beam Angle	120°
Voltage	DC: 12V	IP Rating	IP20 ; IP54
Flux/Meter	500lm/m	Width	10mm

SKU: 4311 RGB IP20
 SKU: 4315 RGB IP54

LED Strip 12V 5050 60 LEDs
14.4W/m

Product code	ST5050-A1	LED Qty	60 SMD/m
Type LED	SMD 5050	Material	Flex PCB
Power/Meter	14.4W/m	Beam Angle	120°
Voltage	DC: 12V	IP Rating	IP20 ; IP54
Flux/Meter	1000lm/m	Width	10mm

SKU: 4312 RGB IP20
 SKU: 4316 RGB IP54

LED Strip 24V 5050 60 LEDs
14.4W/m

Product code	ST5050-A1	LED Qty	60 SMD/m
Type LED	SMD 5050	Material	Flex PCB
Power/Meter	14.4W/m	Beam Angle	120°
Voltage	DC: 24V	IP Rating	IP20 ; IP54
Flux/Meter	1000lm/m	Width	10mm

SKU: 4861 RGB 3800156648616 IP20
 SKU: 4862 RGB 3800156648623 IP54



LED Strip 12V 4040 60 LEDs
8.5W/m - Non Waterproof

Product code	ST4040-A1	LED Qty	60 SMD/m
Type LED	SMD 4040	Material	Flex PCB
Power/Meter	8.5W/m	Beam Angle	120°
Voltage	DC: 12V	IP Rating	IP20
Flux/Meter	500lm/m	Width	10mm

SKU: 4921 SKU:4922 SKU: 4923
 ■ 6000K ■ 4500K ■ 2700K

LED Strip 24V 2835 120 LEDs
9.6W/m - Non Waterproof

Product code	ST2835-A3	LED Qty	120 SMD/m
Type LED	SMD 2835	Material	Flex PCB
Power/Meter	9.6W/m	Beam Angle	120°
Voltage	DC: 24V	IP Rating	IP20
Flux/Meter	1200lm/m	Width	10mm

SKU: 4856 SKU:4857 SKU: 4858
 ■ 6000K ■ 4500K ■ 2700K

LED Strip 12V 4014 120 LEDs
12W/m - Non Waterproof

Product code	ST4014-A1	LED Qty	120 SMD/m
Type LED	SMD 4014	Material	Flex PCB
Power/Meter	12W/m	Beam Angle	120°
Voltage	DC: 12V	IP Rating	IP20
Flux/Meter	1000lm/m	Width	8mm

SKU: 4904 SKU:4905 SKU: 4906
 ■ 6000K ■ 4500K ■ 2700K

LED Strip 24V 5050 60 LEDs
14.4W/m - Non Waterproof

Product code	ST5050-A3	LED Qty	60 SMD/m
Type LED	SMD 5050	Material	Flex PCB
Power/Meter	14.4W/m	Beam Angle	120°
Voltage	DC: 24V	IP Rating	IP20
Flux/Meter	600lm/m	Width	10mm

SKU: 4851 SKU:4850 SKU: 4852
 ■ 6000K ■ 4500K ■ 2700K

LED Strip 12V 5630 60 LEDs
12W/m - Non Waterproof

Product code	ST5630-A1	LED Qty	60 SMD/m
Type LED	SMD 5630	Material	Flex PCB
Power/Meter	12W/m	Beam Angle	120°
Voltage	DC: 12V	IP Rating	IP20
Flux/Meter	1000lm/m	Width	10mm

SKU: 4911 SKU:4913 SKU: 4912
 ■ 6000K ■ 4500K ■ 2700K

LED Strip 24V 5050 60 LEDs
14.4W/m - Waterproof

Product code	ST5050-A4	LED Qty	60 SMD/m
Type LED	SMD 5050	Material	Flex PCB
Power/Meter	14.4W/m	Beam Angle	120°
Voltage	DC: 24V	IP Rating	IP54
Flux/Meter	600lm/m	Width	10mm

SKU: 4853 SKU:4854 SKU: 4855
 ■ 6000K ■ 4500K ■ 2700K



LED Strip 24V COB 320 LEDs
10W/m - Non Waterproof

Product code	ST320-A1	LED Qty	320 SMD/m
Type LED	COB	Material	Flex PCB
Power/Meter	10W/m	Beam Angle	120°
Voltage	DC: 24V	IP Rating	IP20
Flux/Meter	900lm/m	Width	10mm

SKU: 4941 SKU:4942 SKU: 4943
 6000K 4000K 3000K

LED Strip 24V COB 512 LEDs
12W/m - Non Waterproof

Product code	ST512-A1	LED Qty	512 SMD/m
Type LED	COB	Material	Flex PCB
Power/Meter	10W/m	Beam Angle	120°
Voltage	DC: 24V	IP Rating	IP20
Flux/Meter	1100lm/m	Width	10mm

SKU: 4944 SKU: 4945 SKU: 4946
 6000K 4000K 3000K

Middel connector

SKU: 6622

One end connector with wire

SKU: 6623

Two end connector

SKU: 6624

LED Strip 24V 2835 196 LEDs
20W/m - Non Waterproof

Product code	ST2835-A4	LED Qty	196 SMD/m
Type LED	SMD 2835	Material	Flex PCB
Power/Meter	20W/m	Beam Angle	120°
Voltage	DC: 24V	IP Rating	IP20
Flux/Meter	2100lm/m	Width	12mm

SKU: 4421 SKU: 4422 SKU: 4423
 6000K 4500K 2700K

LED Strip 24V 2835 196 LEDs
20W/m - Waterproof

Product code	ST2835-A5	LED Qty	196 SMD/m
Type LED	SMD 2835	Material	Flex PCB
Power/Meter	20W/m	Beam Angle	120°
Voltage	DC: 24V	IP Rating	IP65
Flux/Meter	2100lm/m	Width	12mm

SKU: 4451 SKU: 4452 SKU: 4453
 6000K 4500K 2700K

LED Strip 24V 5054 60 LEDs
16W/m - Non Waterproof

Product code	ST5054-A1	LED Qty	60 SMD/m
Type LED	SMD 5054	Material	Flex PCB
Power/Meter	16W/m	Beam Angle	120°
Voltage	DC: 24V	IP Rating	IP20
Flux/Meter	1100lm/m	Width	12mm

SKU: 4431 SKU: 4432 SKU: 4433
 6000K 4500K 2700K



LED Strip 24V COB 320 LEDs D Shape
20W/m - Waterproof

Product code	ST320-A2	LED Qty	320 SMD/m
Type LED	COB	Material	Flex PCB
Power/Meter	10W/m	Beam Angle	120°
Voltage	DC: 24V	IP Rating	IP65
Flux/Meter	900lm/m	Width	10x4mm

SKU: 4947 SKU: 4948 SKU: 4949
 ■ 6000K ■ 4500K ■ 3000K

LED Strip 24V COB 320 LEDs
10W/m - Non Waterproof

Product code	ST320-A2	LED Qty	320 SMD/m
Type LED	COB	Material	Flex PC
Power/Meter	10W/m	Beam Angle	120°
Voltage	DC: 24V	IP Rating	IP20
Flux/Meter	1000lm/m	Dimension	5x5000 mm

SKU: 4931 SKU: 4932 SKU: 4933
 ■ 6000K ■ 4500K ■ 3000K

LED Strip 24V COB 640 LEDs
12W/m - Non Waterproof

Product code	ST640-A1	LED Qty	640 SMD/m
Type LED	COB	Material	Flex PCB
Power/Meter	12W/m	Beam Angle	120°
Voltage	DC: 24V	IP Rating	IP20
Flux/Meter	500lm/m	Width	12x2.5mm

SKU: 4950
 ■ + ■ RGB+6000K

LED Strip 48V COB 504 LEDs
6W/m - Non Waterproof

Product code	ST320-A2	LED Qty	504 SMD/m
Type LED	COB	Material	Flex PC
Power/Meter	6W/m	Beam Angle	120°
Voltage	DC: 48V	IP Rating	IP20
Flux/Meter	630lm/m	Dimension	10x25000 mm

SKU: 4934 SKU: 4935 SKU: 4936
 ■ 6000K ■ 4500K ■ 3000K

LED Strip 24V COB 504 LEDs -Milky
6W/m - Waterproof

Product code	ST504-A2	LED Qty	504 SMD/m
Type LED	COB	Material	Flex PC
Power/Meter	6W/m	Beam Angle	120°
Voltage	DC: 24V	IP Rating	IP67
Flux/Meter	500lm/m	Dimension	10x20000 mm

SKU: 4937 SKU: 4938 SKU: 4939
 ■ 6000K ■ 4500K ■ 3000K



NEW PRODUCT

LED Strip 24V 2835 120 LEDs
9W/m - Non Waterproof

20m-Roll



IP20

Product code	ST2835-A3	LED Qty	120 SMD/m
Type LED	SMD 2835	Material	Flex PCB
Power/Meter	9W/m	Beam Angle	120°
Voltage	DC: 24V	IP Rating	IP20
Flux/Meter	1000lm/m	Width	8x2.5mm

 SKU: 4865 SKU: 4866 SKU: 4867
 6000K 4500K 3000K

NEW PRODUCT

LED Strip 24V 2835 120 LEDs
10W/m - Non Waterproof
Runnig Water Effect

5m-Roll



IP20

Product code	ST120-A1	LED Qty	120 SMD/m
Type LED	SMD 2835	Material	Flex PCB
Power/Meter	10W/m	Beam Angle	120°
Voltage	DC: 24V	IP Rating	IP20
Flux/Meter	950lm/m	Width	8x2.5mm

 SKU: 4940
 4500K

NEW PRODUCT

RF Controller For Running Water Effect

 Input: DC12-24V
 Output: 1 group SPI signal
 Mode: 28 kinds
 Central IC point: 2048 point
 Support IC: WS2811, WS2812, 16703, UCS1903
 SIZE: 40x12x5mm

SKU: 6541

NEW PRODUCT

Amplifier

 Voltage: DC5-24V
 Output: 2x4=8 group SPI signal
 Function: Multiple separate controllers by connect in parallel
 Remark: 8 pcs light can change at same step with connection in parallel

SKU: 6542

NEW PRODUCT

 2 PIN connector for 8MM COB
 SKU: 6549

NEW PRODUCT

 2 PIN fasten connector 8MM SMD
 SKU: 6552

NEW PRODUCT

 3 PIN connector 10mm 3PIN SMD
 SKU: 6555

NEW PRODUCT

 5 PIN DUAL connector 10mm 5 IN SMD RGBW
 SKU: 6558

NEW PRODUCT

 SMD 10mm PCB single color 2 pin
 SKU: 6561

NEW PRODUCT

 SMD 10mm PCB 3 pin (CCT, magic RGB) 15cm
 SKU: 6564

NEW PRODUCT

 PIN connector for 8MM SMD
 SKU: 6550

NEW PRODUCT

 2 PIN fasten DUAL connector 8MM COB
 SKU: 6553

NEW PRODUCT

 3 PIN connector with wire 10mm 3PIN SMD
 SKU: 6556

NEW PRODUCT

 6 PIN connecto 12mm 6 PIN SMD
 SKU: 6559

NEW PRODUCT

 DUAL SMD 10mm PCB single color 2 pin
 SKU: 6562

NEW PRODUCT

 SMD 10mm PCB 4 pin (RGB)
 SKU: 6565

NEW PRODUCT

 2 PIN fasten connector 8MM COB
 SKU: 6551

NEW PRODUCT

 2 PIN fasten DUAL connector 8MM SMD
 SKU: 6554

NEW PRODUCT

 5 PIN connector 10mm 5PIN SMD RGBW
 SKU: 6557

NEW PRODUCT

 6 PIN DUAL connector 12mm 6 PIN SMD
 SKU: 6560

NEW PRODUCT

 SMD 10mm PCB 3 pin (CCT, magic RGB)
 SKU: 6563

NEW PRODUCT

 SMD 10mm PCB 5 pin (RGBW)
 SKU: 6566

**LED Strip 24V 5054 60 LEDs
16W/m - Waterproof**
3
Years
Warranty

Product code	ST5054-A2	LED Qty	60 SMD/m
Type LED	SMD 5054	Material	Flex PCB
Power/Meter	16W/m	Beam Angle	120°
Voltage	DC: 24V	IP Rating	IP65
Flux/Meter	1100lm/m	Width	10mm

 SKU: 4461 SKU: 4462 SKU: 4463
 6000K 4500K 2700K

**LED Strip 12V 2835 196 LEDs
20W/m - Non Waterproof**
3
Years
Warranty

Product code	ST2835-A5	LED Qty	196 SMD/m
Type LED	SMD 2835	Material	Flex PCB
Power/Meter	20W/m	Beam Angle	120°
Voltage	DC: 12V	IP Rating	IP20
Flux/Meter	2100lm/m	Width	12mm

 SKU: 4424 SKU: 4425 SKU: 4426
 6000K 4500K 2700K

**LED Strip 24V 5025 60 LEDs
16W/m - CCT Adjustable
Non Waterproof**
3
Years
Warranty

Product code	ST5025-A1	LED Qty	60 SMD/m
Type LED	SMD 5025	Material	Flex PCB
Power/Meter	16W/m	Beam Angle	120°
Voltage	DC: 24V	IP Rating	IP20
Flux/Meter	800lm/m	Width	10mm

 SKU: 4441
 CCT
 6000K 4000K 3000K

**LED Strip 12V 2835 196 LEDs
20W/m - Waterproof**
3
Years
Warranty

Product code	ST2835-A6	LED Qty	196 SMD/m
Type LED	SMD 2835	Material	Flex PCB
Power/Meter	20W/m	Beam Angle	120°
Voltage	DC: 12V	IP Rating	IP65
Flux/Meter	2100lm/m	Width	12mm

 SKU: 4454 SKU: 4455 SKU: 4456
 6000K 4500K 2800K

**LED Strip 24V 5025 60 LEDs
16W/m - CCT Adjustable
Waterproof**
3
Years
Warranty

Product code	ST5025-A2	LED Qty	60 SMD/m
Type LED	SMD 5025	Material	Flex PCB
Power/Meter	16W/m	Beam Angle	120°
Voltage	DC: 24V	IP Rating	IP65
Flux/Meter	800lm/m	Width	10mm

 SKU: 4471
 CCT
 6000K 4000K 3000K

**LED Strip 12V 5050 60 LEDs
16W/m - Non Waterproof**

Product code	ST5050-A7	LED Qty	60 SMD/m
Type LED	SMD 5050	Material	Flex PCB
Power/Meter	16W/m	Beam Angle	120°
Voltage	DC: 12V	IP Rating	IP20
Flux/Meter	1600lm/m	Width	12mm

SKU: 4485 RGB+White Light 3800156644854

SKU: 4486 RGB+Warm White 3800156644861

3
Years
Warranty



LED Strip 12V 5050 60 LEDs
16W/m - Waterproof



Product code	ST5050-A8	LED Qty	60 SMD/m
Type LED	SMD 5050	Material	Flex PCB
Power/Meter	16W/m	Beam Angle	120°
Voltage	DC: 12V	IP Rating	IP65
Flux/Meter	1600lm/m	Width	12mm

3
Years
Warranty

SKU: 4487 RGB+White Light 3800156644878

SKU: 4488 RGB+Warm White 3800156644885



LED Strip 24V 5050 60 LEDs
16W/m Waterproof



Product code	ST5050-A6	LED Qty	60 SMD/m
Type LED	SMD 5050	Material	Flex PCB
Power/Meter	16W/m	Beam Angle	120°
Voltage	DC: 24V	IP Rating	IP65
Flux/Meter	1600lm/m	Width	10mm

3
Years
Warranty

SKU: 4483 RGB+6000K

SKU: 4484 RGB+3000K



LED Strip 24V 5050 60 LEDs
9.5W/m - Non Waterproof



Product code	ST5050-A9	LED Qty	60 SMD/m
Type LED	SMD 5050	Material	Flex PCB
Power/Meter	9.5W/m	Beam Angle	120°
Voltage	DC: 24V	IP Rating	IP20
Flux/Meter	950lm/m	Width	10mm

3
Years
Warranty

SKU: 4480



LED Strip 24V 5050 60 LEDs
16W/m - Non Waterproof



Product code	ST5050-A5	LED Qty	60 SMD/m
Type LED	SMD 5050	Material	Flex PCB
Power/Meter	16W/m	Beam Angle	120°
Voltage	DC: 24V	IP Rating	IP20
Flux/Meter	1600lm/m	Width	10mm

3
Years
Warranty

SKU: 4481 RGB+6000K

SKU: 4482 RGB+3000K



CONNECTOR FOR STRIP 3528
SKU: 5151

CONNECTOR FOR STRIP 5050
SKU: 5152

CONNECTOR FOR STRIP RGB
SKU: 6608

ANGLE CONNECTOR FOR STRIP 3528 8mm
SKU: 6619

ANGLE CONNECTOR FOR STRIP 5050 10mm
SKU: 6620

ANGLE CONNECTOR FOR STRIP RGB 10mm
SKU: 6621

CONNECTOR FOR STRIP DC MALE
SKU: 6610

CONNECTOR FOR STRIP DC FEMALE
SKU: 6611

FLEXIBLE FOR STRIP 3528 DC FEMALE
SKU: 6612

FLEXIBLE FOR STRIP 5050 DC FEMALE
SKU: 6613

FLEXIBLE CONNECTOR FOR LED STRIP RGB
SKU: 6614

FLEXIBLE CONNECTOR FOR LED STRIP 5050
SKU: 6615

FLEXIBLE CONNECTOR FOR LED STRIP 5050
SKU: 6616

FLEXIBLE CONNECTOR FOR STRIP RGB+WH
SKU: 6618

FLEXIBLE FOR RGB LED STRIP WITH PIN
SKU: 6617



SMD 2216

SMD 2110

LED Strip 24V HIGH POWER
SMD2216 ; SMD2110

1900

Lumens



240 pcs

Product code	ST2216-A1
Type LED	SMD 2216
Power/Meter	22W/m
Voltage	DC: 24V
Flux/Meter	1900lm/m

LED Qty	240 SMD/m
Material	Flex PCB
Beam Angle	120°
IP Rating	IP20
Width	10mm

3 Years

Warranty



5m-Roll



IP20

SKU: 4403 ■ 3000K

2200

Lumens



300 pcs

Product code	ST2216-A1
Type LED	SMD 2216
Power/Meter	24W/m
Voltage	DC: 24V
Flux/Meter	2200lm/m

LED Qty	300 SMD/m
Material	Flex PCB
Beam Angle	120°
IP Rating	IP20
Width	10mm

3 Years

Warranty



5m-Roll



IP20

SKU: 4404 ■ 3000K

2500

Lumens



560 pcs

Product code	ST2110-A1
Type LED	SMD 2110
Power/Meter	32W/m
Voltage	DC: 24V
Flux/Meter	2500lm/m

LED Qty	560 SMD/m
Material	Flex PCB
Beam Angle	120°
IP Rating	IP20
Width	12mm

3 Years

Warranty



5m-Roll



IP20

SKU: 4405 ■ 3000K

3400

Lumens



700 pcs

Product code	ST2110-A1
Type LED	SMD 2110
Power/Meter	38W/m
Voltage	DC: 24V
Flux/Meter	3400lm/m

LED Qty	700 SMD/m
Material	Flex PCB
Beam Angle	120°
IP Rating	IP20
Width	12mm

3 Years

Warranty



5m-Roll



IP20

SKU: 4406 ■ 3000K



RGB

3 Years

Warranty



5m-Roll



IP20

LED Digital Strip
Addressable

Product code	ST10-A1
Type LED	WS2811 10 Pixels
Power/Meter	7W/m
Voltage	DC: 12V
Flux/Meter	550lm/m
LED Qty	30 SMD/m
Material	Flex PCB
Beam Angle	120°
IP Rating	IP20
Width	10mm
EAN Code	3800156644908

SKU: 4490

SKU: 4491

SKU: 4492

Product code	ST30-A1
Type LED	WS2812b 30 Pixels
Power/Meter	8W/m
Voltage	DC: 5V
Flux/Meter	600lm/m
LED Qty	30 SMD/m
Material	Flex PCB
Beam Angle	120°
IP Rating	IP20
Width	10mm
EAN Code	3800156644915

Product code	ST60-A1
Type LED	WS2812b 30 Pixels
Power/Meter	16W/m
Voltage	DC: 5V
Flux/Meter	1200lm/m
LED Qty	60 SMD/m
Material	Flex PCB
Beam Angle	120°
IP Rating	IP20
Width	10mm
EAN Code	3800156644922

RGB



Addressable

Digital LED Strip Controller
DC5-24V SD-CARD

Voltage	5V-24V
IP Rating	IP20
Dimension	80x55x20mm
SKU: 6331	

Digital LED Strip Controller
DC5-24V

Voltage	5V-24V
IP Rating	IP20
Dimension	80x55x20mm
SKU: 6332	

LED Strip 12V 5050 30 LEDs - SET
Adapter + ir Controller + Remote

Product code	ST5050-B1	LED Qty	30 SMD/m
Type LED	SMD 5050	Material	Flex PCB
Power/Meter	4W/m	Beam Angle	120°
Voltage	DC: 12V	IP Rating	IP20
Flux/Meter	240lm/m	Width	10mm

SKU: 4321 RGB IP20

LED Strip 12V 5050 30 LEDs - SET
Adapter + Bluetooth Music + Remote

Product code	ST5050-B1	LED Qty	30 SMD/m
Type LED	SMD 5050	Material	Flex PCB
Power/Meter	4W/m	Beam Angle	120°
Voltage	DC: 12V	IP Rating	IP20
Flux/Meter	240lm/m	Width	10mm

SKU: 4328 RGB IP20



Music

LED Strip 12V 5050 60 LEDs - SET
Adapter + ir Controller + Remote

Product code	ST5050-B1	LED Qty	60 SMD/m
Type LED	SMD 5050	Material	Flex PCB
Power/Meter	8W/m	Beam Angle	120°
Voltage	DC: 12V	IP Rating	IP20
Flux/Meter	480lm/m	Width	10mm

SKU: 4322 RGB IP20

LED Strip 12V 5050 60 LEDs - SET
Adapter + Bluetooth Music + Remote

Product code	ST5050-B1	LED Qty	60 SMD/m
Type LED	SMD 5050	Material	Flex PCB
Power/Meter	8W/m	Beam Angle	120°
Voltage	DC: 12V	IP Rating	IP20
Flux/Meter	480lm/m	Width	10mm

SKU: 4329 RGB IP20



Music

LED Strip 12V 5050 60 LEDs - SET
Adapter + ir Controller + Remote
Waterproof

Product code	ST5050-B1	LED Qty	60 SMD/m
Type LED	SMD 5050	Material	Flex PCB
Power/Meter	8W/m	Beam Angle	120°
Voltage	DC: 12V	IP Rating	IP54
Flux/Meter	480lm/m	Width	10mm

SKU: 4323 RGB IP54

LED Strip 12V 5050 60 LEDs - SET
Adapter + Bluetooth Music + Remote
Waterproof

Product code	ST5050-B1	LED Qty	60 SMD/m
Type LED	SMD 5050	Material	Flex PCB
Power/Meter	8W/m	Beam Angle	120°
Voltage	DC: 12V	IP Rating	IP54
Flux/Meter	480lm/m	Width	10mm

SKU: 4330 RGB IP54



Music

**Smart LED Strip 12V 5050+2835 - SET
 Adapter + Wifi Controller**

Wi Fi	Product code	ST5050-B1	LED Qty	60 SMD/m
	Type LED	SMD 5050+2835	Material	Flex PCB
	Power/Meter	4W/m	Beam Angle	120°
	Voltage	DC: 12V	IP Rating	IP20
	Flux/Meter	240lm/m	Width	10mm

SKU: 4324 RGB+W IP20

SKU: 4325 RGB+WW IP20

**Smart LED Strip 12V CCT 5050+2835 -SET
 Adapter + Wifi Controller**



Wi Fi	Product code	ST5050-B1	LED Qty	90 SMD/m
	Type LED	SMD 5050+2835	Material	Flex PCB
	Power/Meter	6W/m	Beam Angle	120°
	Voltage	DC: 12V	IP Rating	IP54
	Flux/Meter	360lm/m	Width	12mm

SKU: 4326 RGB+CCT IP20

**TV LED Strip 5V 5050+2835 60LEDs - SET
 Wifi Controller + Remote**

Product code	ST5050-B1	LED Qty	60 SMD/m
Type LED	SMD 5050+2835	Material	Flex PCB
Power/Meter	4W/m	Beam Angle	120°
Voltage	DC: 5V	IP Rating	IP20
Flux/Meter	240lm/m	Width	10mm

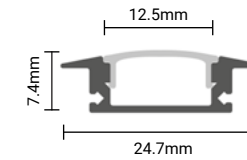
SKU: 4327 RGB+WW IP20



SKU: 5104 Black Body- White Cover (L=2m)

SKU: 5105 Black Body- Black Cover (L=2m)

SKU: 5106 White Body- White Cover (L=2m)

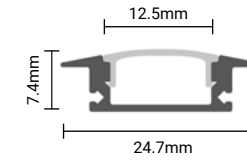

SKU: 5193 Silver Body- White Cover (L=1m)

SKU: 5192 Silver Body- White Cover (L=2m)

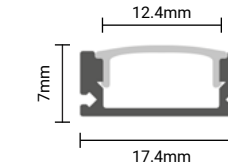

SKU: 5190 Silver Body- White Cover (L=1m)

SKU: 5191 Silver Body- White Cover (L=2m)

SKU: 5184 White Body- White Cover (L=2m)

SKU: 5185 Black Body- White Cover (L=2m)

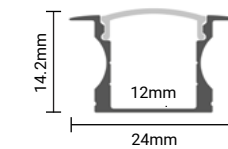

SKU: 5108 Silver Body- White Cover (L=2m)

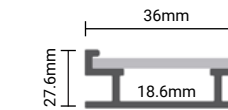

SKU: 5113 Silver Body- White Cover (L=2m)

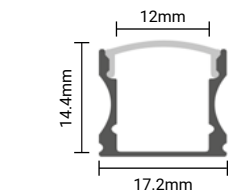

SKU: 5175 Silver Body- White Cover (L=2m)

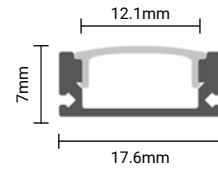

SKU: 5107 Black Body- Black Cover (L=2m) ■■

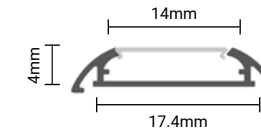

SKU: 5002 Bendable -Silver body (L=1m) ■

SKU: 5001 Bendable -Silver body (L=2m) ■

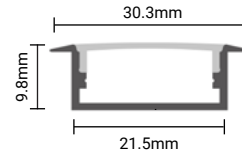

SKU: 5109 Silver Body- White Cover (L=2m) ■□

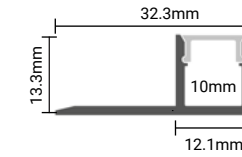
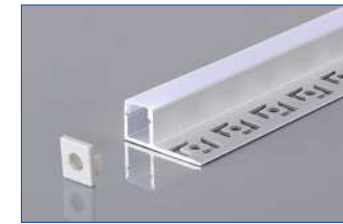

SKU: 5111 Silver Body- White Cover (L=2m) ■□

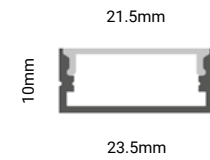

SKU: 5183 Silver Body- White Cover (L=2m) ■□

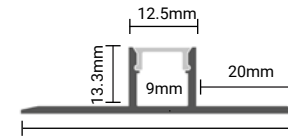
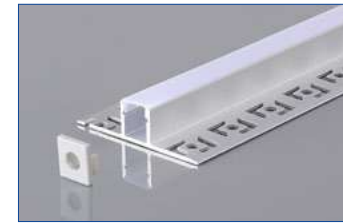

SKU: 5112 Silver Body- White Cover (L=2m) ■□

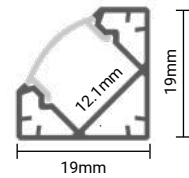

SKU: 5101 Black Body- Black Cover (L=2m) ■□

SKU: 5102 White Body- White Cover (L=2m) □□

SKU: 5103 Silver Body- White Cover (L=2m) ■□

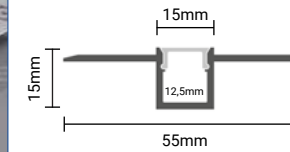

SKU: 5162 Silver Body- White Cover (L=2m) ■□

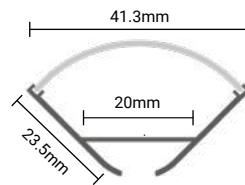

SKU: 5110 Silver Body- White Cover (L=2m) ■□

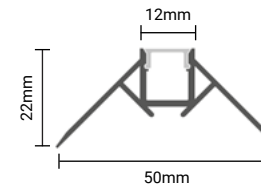

SKU: 5165 Silver Body- White Cover (L=2m) ■□

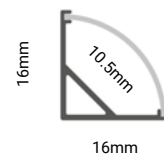

SKU: 5150 Silver Body- White Cover (L=2m) ■□

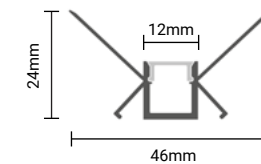

SKU: 5166 Silver Body- White Cover (L=2m) ■□

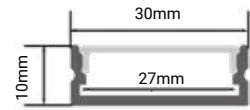

SKU: 5114 Black Body- Black Cover (L=2m) ■■

SKU: 5115 Silver Body- White Cover (L=2m) □□

SKU: 5116 Black Body- White Cover (L=2m) ■□

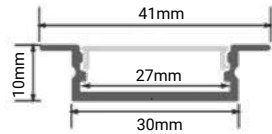

SKU: 5117 Black Body- Black Cover (L=2m) ■■

SKU: 5118 Silver Body- White Cover (L=2m) □□

SKU: 5119 Black Body- White Cover (L=2m) ■□

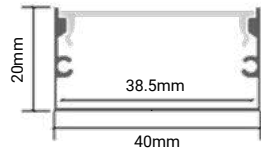

SKU: 5120 Black Body- Black Cover (L=2m) ■■

SKU: 5121 Silver Body- White Cover (L=2m) □□

SKU: 5122 Black Body- White Cover (L=2m) ■□

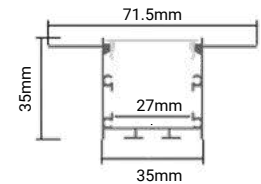

SKU: 5123 Black Body- Black Cover (L=2m) ■■

SKU: 5124 Silver Body- White Cover (L=2m) □□

SKU: 5125 Black Body- White Cover (L=2m) ■□

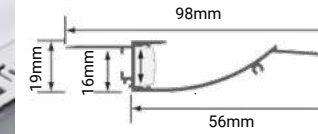

SKU: 5128 Silver Body- White Cover (L=2m) □□

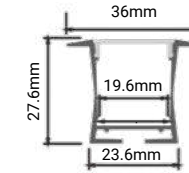

SKU: 5130 Silver Body- White Cover (L=2m) □□

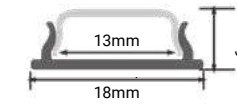

SKU: 5132 Silver Body- White Cover (L=2m) □□

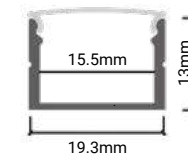

SKU: 5133 Silver Body- White Cover (L=2m) □□

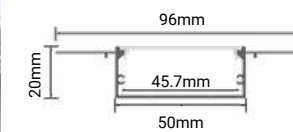

SKU: 5134 Silver Body- White Cover (L=2m) □□



LED STRIPS 220V AND FLEX NEON

The new range of silicone encapsulated Neon by OPTONICA LED comprises of highly durable and flexible linear LED Solutions - suitable for both indoor and outdoor architectural applications. Designed using high-grade silicone, the neon is:

- Able to withstand wide temperature amplitudes
- Resistant to the build-up of dirt and dust, making it the first to come with a self-cleaning property
- Waterproof and impact resistant
- UV, flame and solvent resistant

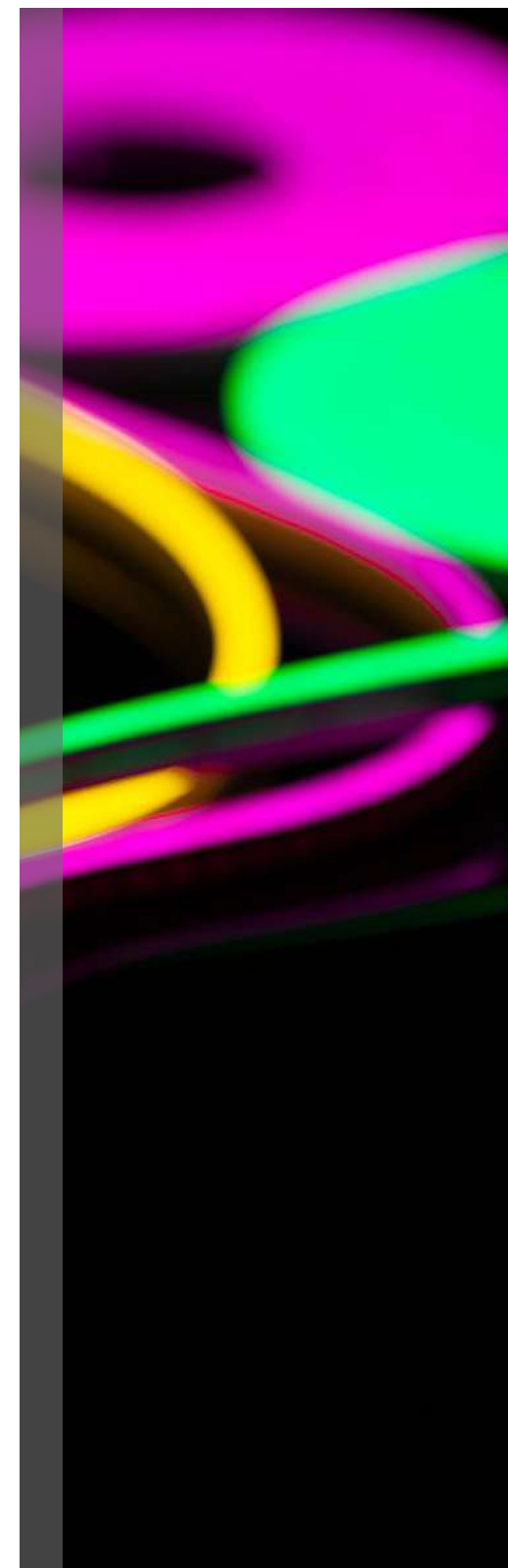



LED Strip S-Type 12V 2835 60 LEDs
7.2W/m - Non Waterproof

Product code	M02835-A2	LED Qty	60 SMD/m
Type LED	SMD 2835	Material	Flex PCB
Power/Meter	7.2W/m	Beam Angle	120°
Voltage	DC: 12V	IP Rating	IP20
Flux/Meter	720lm/m	Width	6mm

3
Years
Warranty



5m-Roll



IP20

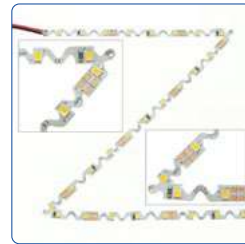

Free Angle Bending

SKU: 4541 SKU: 4546 SKU: 4542
■ 6000K ■ 4000K ■ 3000K



LED Strip S-Type 12V 2835 60 LEDs
7.2W/m - Waterproof

Product code	M02835-A2	LED Qty	60 SMD/m
Type LED	SMD 2835	Material	Flex PCB
Power/Meter	7.2W/m	Beam Angle	120°
Voltage	DC: 12V	IP Rating	IP65
Flux/Meter	720lm/m	Width	6mm

3
Years
Warranty



5m-Roll



IP65

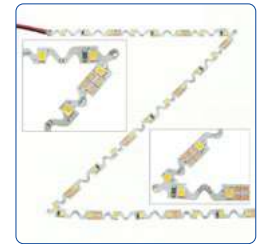

Free Angle Bending

SKU: 4551 SKU: 4552
■ 6000K ■ 2700K



LED Strip S-Type 12V 2835 60 LEDs
7.2W/m - Non Waterproof

Product code	M02835-A2	LED Qty	60 SMD/m
Type LED	SMD 2835	Material	Flex PCB
Power/Meter	7.2W/m	Beam Angle	120°
Voltage	DC: 12V	IP Rating	IP20
Flux/Meter	720lm/m	Width	6mm

3
Years
Warranty



5m-Roll



IP20

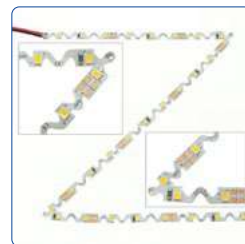

Free Angle Bending

SKU: 4543 SKU: 4545 SKU: 4544
■ RED ■ GREEN ■ BLUE



LED Strip S-Type 12V 2835 60 LEDs
7.2W/m - Waterproof

Product code	M02835-A2	LED Qty	60 SMD/m
Type LED	SMD 2835	Material	Flex PCB
Power/Meter	7.2W/m	Beam Angle	120°
Voltage	DC: 12V	IP Rating	IP65
Flux/Meter	720lm/m	Width	6mm

3
Years
Warranty



5m-Roll



IP65

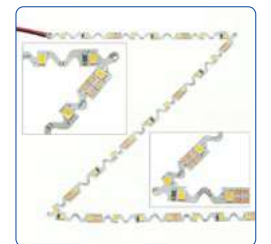

Free Angle Bending

SKU: 4553 SKU: 4555 SKU: 4554
■ RED ■ GREEN ■ BLUE



/m
120 pcs

-Roll
50m-Roll

IP65



/m
120 pcs

-Roll
50m-Roll

IP65



LED FLEX NEON 12V -50m Roll
2835 120 SMD/m

Product code	ST12-A2	LED Qty	120 SMD/m
Type LED	SMD 2835	Material	Flex PC
Power/Meter	6W/m	Beam Angle	120°
Voltage	DC: 12V	IP Rating	IP65
Flux/Meter	300lm/m	Dimension	16x8 mm

SKU: 4590	6000K	
SKU: 4591	4000K	
SKU: 4592	2800K	
SKU: 4593	Blue	
SKU: 4594	Red	
SKU: 4595	Green	
SKU: 4596	Ice Blue	
SKU: 4597	Lemon	
SKU: 4598	Golden	
SKU: 4599	PURPLE	

LED FLEX NEON 220V -50m Roll
2835 120 SMD/m

Product code	ST220-A2	LED Qty	120 SMD/m
Type LED	SMD 2835	Material	Flex PC
Power/Meter	8.5W/m	Beam Angle	120°
Voltage	AC: 220V	IP Rating	IP65
Flux/Meter	300lm/m	Dimension	Single 16x10 mm RGB 25x13 mm

SKU: 4581	6000K	
SKU: 4580	4000K	
SKU: 4582	2800K	
SKU: 4584	RED	
SKU: 4585	GREEN	
SKU: 4583	BLUE	
SKU: 4587	YELLOW	
SKU: 4586	AMBER	
SKU: 4588	PINK	
SKU: 4589	RGB	

PLUG IN + CONNECTOR PIN



SKU: 6602

MOUNTING BRACKET



SKU: 6603

ALUMINIUM CLIPS



SKU: 6601

END CAP FOR



SKU: 6605

INPUT CABLE + CONNECTOR + PLUG



SKU: 6635

MIDDLE CONNECTOR



SKU: 6634

ALUMINIUM CHANNEL WITH 2 SCREWS



SKU: 6636

END CAP FOR SINGLE COLOUR



SKU: 6637

CONNECTOR PLUG



SKU: 6604



POWER CABLE+RGB CONTROLLER



SKU: 6638

ALUMINIUM CHANNEL , 5CM RGB



SKU: 6639

END CAP FOR RGB



SKU: 6640

NEW PRODUCT



LED Strips 220V -50m Roll
2835 120 SMD/m

120 pcs/m

IP65

Product code ST220-A3
Type LED SMD 2835
Power/Meter 9W/m
Voltage AC: 220V
Flux/Meter 900lm/m

LED Qty 120 SMD/m
Material Flex PC
Beam Angle 120°
IP Rating IP65
Dimension 10x4.3 mm

SKU: 4951 6000K
SKU: 4952 4500K
SKU: 4953 3000K

50m-Roll



INPUT CABLE + CONNECTOR
SKU: 6543



FIX CLIP
SKU: 6544



END CAP FOR 2835
SKU: 6545



120 pcs/m

50m-Roll

IP65

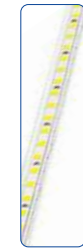

LED Strips 220V -50m Roll
5730 120 SMD/m

Product code ST220-A1
Type LED SMD 5730
Power/Meter 10W/m
Voltage AC: 220V
Flux/Meter 500lm/m

LED Qty 120 SMD/m
Material Flex PC
Beam Angle 120°
IP Rating IP65
Dimension 13x5 mm

SKU: 4611 6000K
SKU: 4613 4000K
SKU: 4612 2800K

NEW PRODUCT

NEW PRODUCT



LED Strips COB 220V -50m Roll
COB Waterproof

288 pcs/m

IP65

Product code ST228-A1
Type LED COB
Power/Meter 10W/m
Voltage AC: 220V
Flux/Meter 700lm/m

LED Qty 288 SMD/m
Material Flex PC
Beam Angle 120°
IP Rating IP65
Dimension 12x5 mm

SKU: 4954 6000K
SKU: 4955 4500K
SKU: 4956 3000K

50m-Roll



INPUT CABLE + CONNECTOR
SKU: 6546



FIX CLIP
SKU: 6547



END CAP FOR COB
SKU: 6548



2835/5730 INPUT CABLE + CONNECTOR
SKU: 6631



2835/5730 MIDDLE CONNECTOR
SKU: 6633



2835/5730 FIXING
SKU: 6632



END CAP FOR 220V
SKU: 6627



LENS LED Module 1.6W - 220V
3x2835 SMD - Waterproof

 100
 Lumens

IP67

Product code	M0220-A1	LED Qty	3 pcs
Type LED	SMD 2835	Material	PC
Power/Module	1.2W	Beam Angle	160°
Voltage	AC: 220-265V	IP Rating	IP67
Flux/Watt	84lm/W	Dimension	88x22x11mm

SKU: 4564 White Light 6500K

 3
 Years
 Warranty

LED Module 2.4W
4x2835 SMD - Waterproof

 85
 Lumens

IP65

Product code	M02835-A1	LED Qty	4 pcs
Type LED	SMD 2835	Material	PC
Power/Module	2.4W	Beam Angle	160°
Voltage	DC: 12V	IP Rating	IP65
Flux/Watt	35lm/W	Dimension	43x38x6.5mm

SKU: 4561 White Light 6500K 3800156645615

SKU: 4562 Warm White 3000K 3800156645622

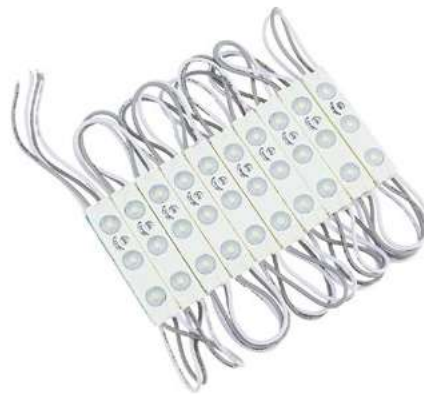
 3
 Years
 Warranty

LENS LED Module 0.72W
3x2835 SMD - Waterproof

 80
 Lumens

IP65

Product code	M02835-A1	LED Qty	3 pcs
Type LED	SMD 2835	Material	PC
Power/Module	0.72W	Beam Angle	160°
Voltage	DC: 12V	IP Rating	IP65
Flux/Watt	110lm/W	Dimension	58x12mm

 SKU: 4512 White Light 10000K
 SKU: 4511 White Light 6500K
 SKU: 4513 Warm White 3000K
 SKU: 4514 RED
 SKU: 4516 GREEN
 SKU: 4515 BLUE

 3
 Years
 Warranty

LENS LED Module 0.72W
3x5050 SMD - Waterproof

 85
 Lumens

IP65

Product code	M05050-A1	LED Qty	3 pcs
Type LED	SMD 5050	Material	PC
Power/Module	0.72W	Beam Angle	120°
Voltage	DC: 12V	IP Rating	IP65
Flux/Watt	118lm/W	Dimension	70x16x8mm

SKU: 4563 RGB

 3
 Years
 Warranty

LENS LED Module 1.5W
3x2835 SMD - Waterproof

 120
 Lumens

IP65

Product code	M02835-A1	LED Qty	3 pcs
Type LED	SMD 2835	Material	PC
Power/Module	1.5W	Beam Angle	160°
Voltage	DC: 12V	IP Rating	IP65
Flux/Watt	80lm/W	Dimension	75x15mm

 SKU: 4522 White Light 10000K
 SKU: 4521 White Light 6500K
 SKU: 4523 Warm White 3000K
 SKU: 4524 RED
 SKU: 4526 GREEN
 SKU: 4525 BLUE

 3
 Years
 Warranty

LED Module 0.36W
3x3014 SMD - Waterproof

 30
 Lumens

IP65

Product code	M03014-A1	LED Qty	3 pcs
Type LED	SMD 3014	Material	PC
Power/Module	0.36W	Beam Angle	120°
Voltage	DC: 12V	IP Rating	IP65
Flux/Watt	85lm/W	Dimension	18x8x2.9mm

 SKU: 4531 White Light 6500K
 SKU: 4532 Warm White 3000K
 SKU: 4533 RED
 SKU: 4535 GREEN
 SKU: 4534 BLUE

 3
 Years
 Warranty



LED POWER SUPPLIES



Our portfolio covers best-performing all world-wide LVD power standards including narrow-body for installation ease in tricky spaces. Cost-efficient on your utility bills and your maintenance budget.

Features:

- 5V, 12V and 24V units come in a choice of sizes and shapes
- Specialized dimmable products for panels and downlights
- Waterproof options available with various degree of ingress-protection ratings
- Extended life cycle through forced heat dissipation, making them utmost reliable

Application:

- The natural choice for each LED strip design and installation
- A vital part of any lighting application





Dimmable



TRIAC Dimmable Power Supplies

Metal 12V Output

3 Years
Warranty

DC:12V

IP20

SKU: 6271 75W - 12V
SKU: 6272 100W - 12V
SKU: 6273 150W - 12V

Watts	75W	100W	150W
Input Voltage	220-240V	220-240V	220-240V
Output Voltage	DC: 12V	DC: 12V	DC: 12V
Current	6.25A	8.33A	12.5A
Material	Metal	Metal	Metal
IP Rating	IP20	IP20	IP20
Dimension	190x50x31mm	206x67x37mm	206x67x37mm

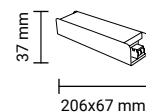
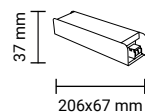
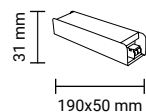

Power Supplies for Track Light

Metal 48V Output

DC:48V

IP20

SKU: 6284 120W - 48V

SKU: 6285 250W - 48V

Watts	120W	250W
Input Voltage	220V	220V
Output Voltage	DC: 48V	DC: 48V
Current	2.5A	5.2A
Material	Metal	Metal
IP Rating	IP20	IP20
Dimension	190x90x30mm	220x120x30mm

TRIAC Dimmable Power Supplies

Metal 24V Output

3 Years
Warranty

DC:24V

IP20

SKU: 6281 75W - 24V
SKU: 6282 100W - 24V
SKU: 6283 150W - 24V

Watts	75W	100W	150W
Input Voltage	220-240V	220-240V	220-240V
Output Voltage	DC: 24V	DC: 24V	DC: 24V
Current	3.1A	4.17A	6.25A
Material	Metal	Metal	Metal
IP Rating	IP20	IP20	IP20
Dimension	119x52x32mm	206x67x37mm	206x67x37mm

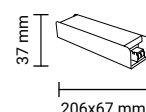
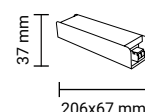
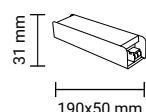



Strip Power Supplies Premium
Plastic 12V Output

3 Years
Warranty

DC:12V

IP20

SKU: 6201 36W - 12V
SKU: 6202 60W - 12V
SKU: 6203 72W - 12V

Watts	36W	60W	72W
Input Voltage	100-240V	100-240V	100-240V
Output Voltage	DC: 12V	DC: 12V	DC: 12V
Current	3A	5A	6A
Material	Plastic	Plastic	Plastic
IP Rating	IP20	IP20	IP20
Dimension	119x52x32mm	119x52x32mm	119x52x32mm

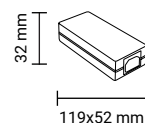
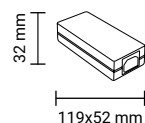
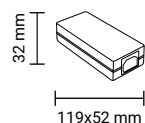

Strip Power Supplies Premium
SLIM - Metal 12V Output

3 Years
Warranty

DC:12V

IP20

SKU: 6211 60W - 12V
SKU: 6212 100W - 12V
SKU: 6213 150W - 12V
SKU: 6214 200W - 12V

Watts	60W	100W	150W	200W
Input Voltage	100-240V	100-240V	176-265V	176-265V
Output Voltage	DC: 12V	DC: 12V	DC: 12V	DC: 12V
Current	5A	8.4A	12.5A	16.7A
Material	Metal	Metal	Metal	Metal
IP Rating	IP20	IP20	IP20	IP20
Dimension	130x50x31mm	190x50x31mm	200x62x31mm	208x82x32mm

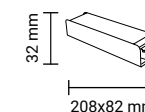
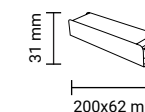
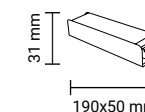
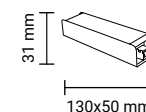

Strip Power Supplies Premium
Plastic 24V Output

3 Years
Warranty

DC:24V

IP20

SKU: 6206 36W - 24V
SKU: 6207 60W - 24V
SKU: 6208 72W - 24V

Watts	36W	60W	72W
Input Voltage	100-240V	100-240V	100-240V
Output Voltage	DC: 24V	DC: 24V	DC: 24V
Current	1.5A	2.5A	3A
Material	Plastic	Plastic	Plastic
IP Rating	IP20	IP20	IP20
Dimension	119x52x32mm	119x52x32mm	119x52x32mm

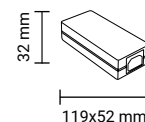
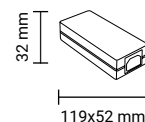
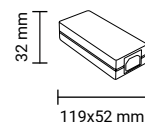

Strip Power Supplies Premium
SLIM - Metal 24V Output

3 Years
Warranty

DC:24V

IP20

SKU: 6221 60W - 24V
SKU: 6222 100W - 24V
SKU: 6223 150W - 24V
SKU: 6224 200W - 24V

Watts	60W	100W	150W	200W
Input Voltage	100-240V	100-240V	176-265V	176-265V
Output Voltage	DC: 24V	DC: 24V	DC: 24V	DC: 24V
Current	2.5A	4.2A	6.25A	8.35A
Material	Metal	Metal	Metal	Metal
IP Rating	IP20	IP20	IP20	IP20
Dimension	130x50x31mm	190x50x31mm	200x60x31mm	208x82x32mm

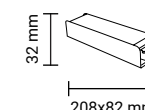
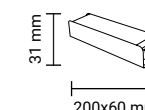
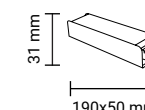
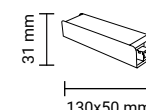



**Strip Power Supplies Premium
Plastic Case 12V Output**
3
 Years
 Warranty

 DC:12V

 IP20

 SKU: 6231 24W - 12V
 SKU: 6232 36W - 12V
 SKU: 6233 60W - 12V

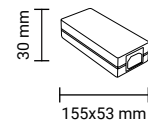
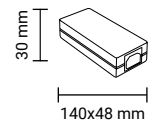
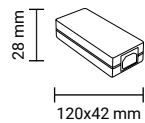
Watts	24W	36W	60W
Input Voltage	100-240V	100-240V	100-240V
Output Voltage	DC: 12V	DC: 12V	DC: 12V
Current	2A	3A	5A
Material	Plastic	Plastic	Plastic
IP Rating	IP20	IP20	IP20
Dimension	120x42x28mm	140x48x30mm	155x53x30mm



**Strip Power Supplies Premium
Plastic Case 24V Output**
3
 Years
 Warranty

 DC:24V

 IP20

 SKU: 6241 24W - 24V
 SKU: 6242 36W - 24V
 SKU: 6243 60W - 24V

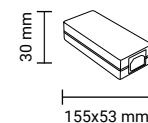
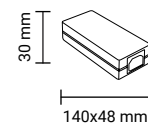
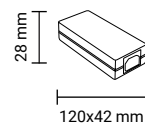
Watts	24W	36W	60W
Input Voltage	100-240V	100-240V	100-240V
Output Voltage	DC: 24V	DC: 24V	DC: 24V
Current	1A	1.5A	2.5A
Material	Plastic	Plastic	Plastic
IP Rating	IP20	IP20	IP20
Dimension	120x42x28mm	140x48x30mm	155x53x30mm



**Strip Power Supplies Premium
Waterproof 12V Output**
3
 Years
 Warranty

 DC:12V

 IP67

 SKU: 6251 60W - 12V
 SKU: 6252 100W - 12V
 SKU: 6253 150W - 12V
 SKU: 6254 200W - 12V

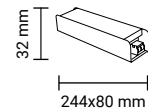
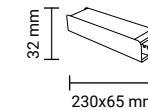
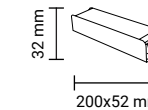
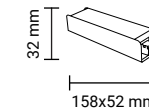
Watts	60W	100W	150W	200W
Input Voltage	100-240V	100-240V	176-265V	176-265V
Output Voltage	DC: 12V	DC: 12V	DC: 12V	DC: 12V
Current	5A	8.4A	12.5A	16.7A
Material	Metal	Metal	Metal	Metal
IP Rating	IP67	IP67	IP67	IP67
Dimension	158x52x32mm	220x52x32mm	233x65x32mm	244x80x32mm



**Strip Power Supplies Premium
Waterproof 24V Output**
3
 Years
 Warranty

 DC:24V

 IP67

 SKU: 6261 60W - 24V
 SKU: 6262 100W - 24V
 SKU: 6263 150W - 24V
 SKU: 6264 200W - 24V

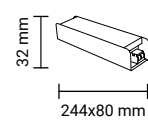
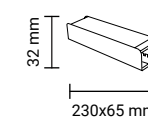
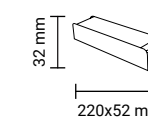
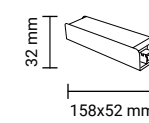
Watts	60W	100W	150W	200W
Input Voltage	100-240V	100-240V	176-265V	176-265V
Output Voltage	DC: 24V	DC: 24V	DC: 24V	DC: 24V
Current	2.5A	4.2A	6.25A	8.35A
Material	Metal	Metal	Metal	Metal
IP Rating	IP67	IP67	IP67	IP67
Dimension	158x52x32mm	220x52x32mm	230x65x32mm	244x80x32mm



 Strip Power Supplies
Plastic 12V Output

DC:12V



IP20

SKU: 6120	18W - 12V
SKU: 6101	24W - 12V
SKU: 6102	36W - 12V
SKU: 6103	60W - 12V
SKU: 6119	80W - 12V

18W

Product Code	AC18-A1	Current	1,5A
Watts	18W	Material	Plastic
Input Voltage	220-240V	IP Rating	IP20
Output Voltage	DC: 12V	Dimension	85x50x34mm

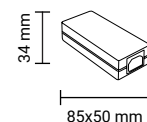
**24W**

Product Code	AC24-A1	Current	2A
Watts	24W	Material	Plastic
Input Voltage	220-240V	IP Rating	IP20
Output Voltage	DC: 12V	Dimension	90x50x31mm

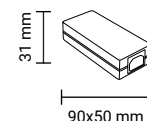
**36W**

Product Code	AC36-A1	Current	3A
Watts	36W	Material	Plastic
Input Voltage	220-240V	IP Rating	IP20
Output Voltage	DC: 12V	Dimension	124x58x32mm

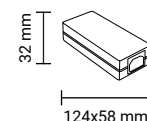
**60W**

Product Code	AC60-A1	Current	5A
Watts	60W	Material	Plastic
Input Voltage	220-240V	IP Rating	IP20
Output Voltage	DC: 12V	Dimension	124x58x32mm

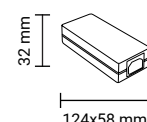
**80W**

Product Code	AC80-A1	Current	6.5A
Watts	80W	Material	Plastic
Input Voltage	220-240V	IP Rating	IP20
Output Voltage	DC:12V	Dimension	136x64x40mm

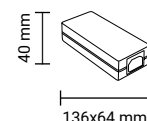

Strip Power Supplies

Waterproof Metal 12V Output

DC:12V



IP67

SKU: 6110	30W - 12V
SKU: 6111	60W - 12V
SKU: 6112	150W - 12V

30W

Product Code	AC30-A7	Current	2.5A
Watts	30W	Material	Aluminium
Input Voltage	220V	IP Rating	IP67
Output Voltage	DC: 12V	Dimension	221x30x34mm

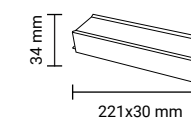
**60W**

Product Code	AC60-A7	Current	5A
Watts	60W	Material	Aluminium
Input Voltage	220V	IP Rating	IP67
Output Voltage	DC: 12V	Dimension	174x67x43mm

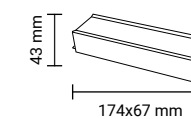
**100W**

Product Code	AC100-A7	Current	8.5A
Watts	100W	Material	Aluminium
Input Voltage	220V	IP Rating	IP67
Output Voltage	DC: 12V	Dimension	237x70x43mm

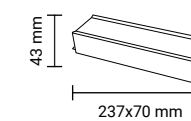
**150W**

Product Code	AC150-A7	Current	12.5A
Watts	150W	Material	Aluminium
Input Voltage	220V	IP Rating	IP67
Output Voltage	DC:12V	Dimension	235x50x85mm

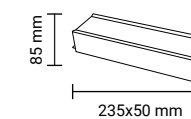



Strip Power Supplies
Metal 12V Output



- SKU: 6104 24W - 12V
- SKU: 6121 36W - 12V
- SKU: 6105 60W - 12V
- SKU: 6109 100W - 12V
- SKU: 6106 120W - 12V

Watts	24W	36W	60W	100W	120W
Input Voltage	220V	220V	220V	220V	220V
Output Voltage	DC: 12V	DC: 12V	DC: 12V	DC: 12V	DC: 12V
Current	2A	3A	5A	8.3A	10A
Material	Metal	Metal	Metal	Metal	Metal
IP Rating	IP20	IP20	IP20	IP20	IP20
Dimension	85x57x34mm	85x57x34mm	115x80x50mm	165x105x50mm	165x105x65mm

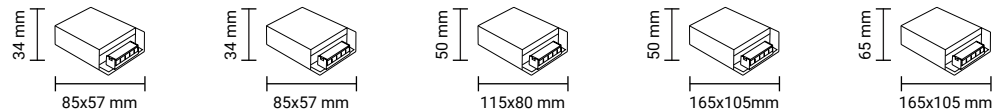

Strip Power Supplies
Metal 12V Output



- SKU: 6114 150W - 12V
- SKU: 6117 250W - 12V
- SKU: 6108 360W - 12V
- SKU: 6124 500W - 12V

Watts	150W	250W	360W	500W
Input Voltage	220V	220V	220V	220V
Output Voltage	DC: 12V	DC: 12V	DC: 12V	DC: 12V
Current	12.5A	20A	30A	41.5A
Material	Metal	Metal	Metal	Metal
IP Rating	IP20	IP20	IP20	IP20
Dimension	205x100x50mm	200x115x55mm	220x115x55mm	220x115x55mm

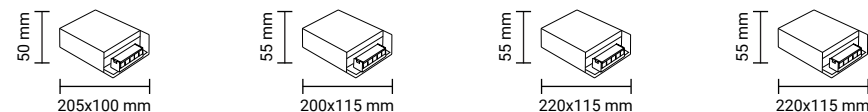

Strip Power Supplies
Metal 24V Output



- SKU: 6154 60W - 24V
- SKU: 6151 100W - 24V
- SKU: 6155 150W - 24V
- SKU: 6152 250W - 24V
- SKU: 6153 360W - 24V

60W

Product Code	AC60-A4	Current	2.5A
Watts	60W	Material	Metal
Input Voltage	220V	IP Rating	IP20
Output Voltage	DC: 24V	Dimension	165x100x45mm

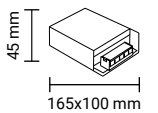

100W

Product Code	AC100-A4	Current	4.2A
Watts	100W	Material	Metal
Input Voltage	220V	IP Rating	IP20
Output Voltage	DC: 24V	Dimension	210x100x45mm

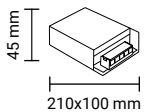

150W

Product Code	AC150-A4	Current	6.25A
Watts	150W	Material	Metal
Input Voltage	220V	IP Rating	IP20
Output Voltage	DC: 24V	Dimension	205x105x50mm

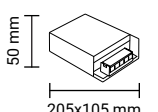

250W

Product Code	AC250-A4	Current	10.5A
Watts	250W	Material	Metal
Input Voltage	220V	IP Rating	IP20
Output Voltage	DC: 24V	Dimension	200x110x50mm

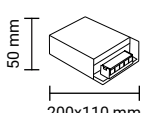

360W

Product Code	AC360-A4	Current	15A
Watts	360W	Material	Metal
Input Voltage	220V	IP Rating	IP20
Output Voltage	DC: 24V	Dimension	220x115x55mm

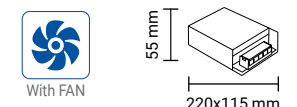



Strip Power Supplies

SLIM - Metal 12V Output

Slim Line



DC12V



IP20

SKU: 6131	60W - 12V
SKU: 6132	100W - 12V
SKU: 6133	150W - 12V
SKU: 6134	250W - 12V
SKU: 6135	360W - 12V

60W

Product Code	AC60-A3	Current	5A
Watts	60W	Material	Metal
Input Voltage	220V	IP Rating	IP20
Output Voltage	DC: 12V	Dimension	170x45x38mm

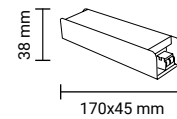
**100W**

Product Code	AC100-A3	Current	8.5A
Watts	100W	Material	Metal
Input Voltage	220V	IP Rating	IP20
Output Voltage	DC: 12V	Dimension	190x48x38mm

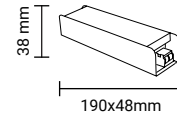
**150W**

Product Code	AC150-A3	Current	12.5A
Watts	150W	Material	Metal
Input Voltage	220V	IP Rating	IP20
Output Voltage	DC: 12V	Dimension	207x63x49mm

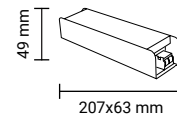
**250W**

Product Code	AC250-A3	Current	20A
Watts	250W	Material	Metal
Input Voltage	220V	IP Rating	IP20
Output Voltage	DC: 12V	Dimension	230x75x45mm

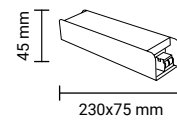

With FAN

**360W**

Product Code	AC360-A3	Current	30A
Watts	360W	Material	Metal
Input Voltage	220V	IP Rating	IP20
Output Voltage	DC: 12V	Dimension	230x75x45mm



With FAN

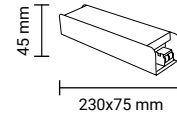

Strip Power Supplies

SLIM - Metal 24V Output

Slim Line



DC:24V



IP20

SKU: 6161	60W - 24V
SKU: 6162	100W - 24V
SKU: 6163	150W - 24V
SKU: 6164	250W - 24V
SKU: 6165	360W - 24V

60W

Product Code	AC60-A4	Current	2.5A
Watts	60W	Material	Metal
Input Voltage	220V	IP Rating	IP20
Output Voltage	DC: 24V	Dimension	170x45x40mm

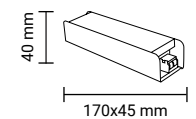
**100W**

Product Code	AC100-A4	Current	4.2A
Watts	100W	Material	Metal
Input Voltage	220V	IP Rating	IP20
Output Voltage	DC: 24V	Dimension	195x40x40mm

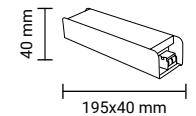
**150W**

Product Code	AC150-A4	Current	6.25A
Watts	150W	Material	Metal
Input Voltage	220V	IP Rating	IP20
Output Voltage	DC: 24V	Dimension	205x65x45mm

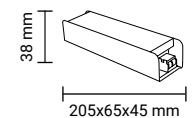
**250W**

Product Code	AC250-A4	Current	10.5A
Watts	250W	Material	Metal
Input Voltage	220V	IP Rating	IP20
Output Voltage	DC: 24V	Dimension	230x75x45mm

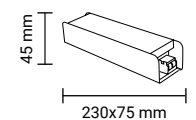

With FAN

**360W**

Product Code	AC360-A4	Current	15A
Watts	360W	Material	Metal
Input Voltage	220V	IP Rating	IP20
Output Voltage	DC: 24V	Dimension	230x75x45mm



With FAN

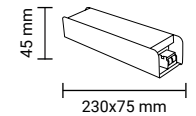

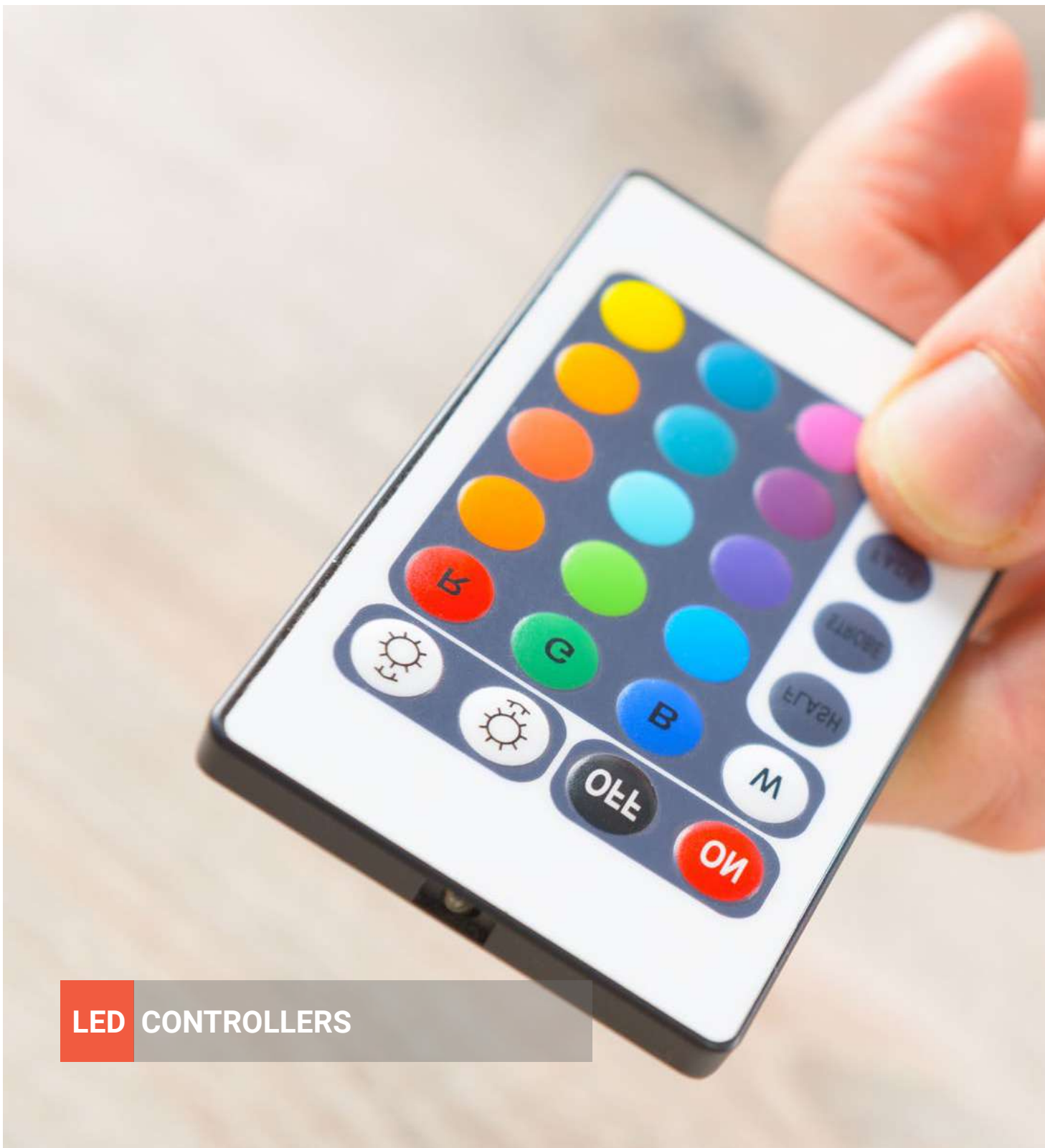

LED strips with all its power and might cannot be fully deployed without the appropriate diverse controllers. Touch sensors, Wi-Fi, smart home or any other popular type are available to diversify modern design and layout.

Features:

- Discreet and contemporary patterns.
- Small giants, an absolute must for any sophisticated lighting architecture
- Plug and play concept

Application:

- Probably the most widely used category with infinite applications

LED CONTROLLERS

**Dimmer LED Strip
With Remote Control 8A**

SKU:	6302
Product Code	AC2-A2
Power	96W-192W
Voltage	12V / 24V
IP Rating	IP20
Dimension	80x55x30mm

**WiFi Controller
RGB / Single Color 3x4A**

SKU:	6310	6311
Product Code	AC2-A2	AC2-A2
Power	90W-288W	90W-288W
Voltage	7.5V-24V	7.5V-24V
Strip Type	RGB	Single Color
Dimension	80x55x30mm	80x55x30mm

**Remote Control LED Strip
RGB - 4 Buttons 3x4A**

SKU:	6304
Product Code	AC2-A2
Power	144W-288W
Voltage	12V / 24V
IP Rating	IP20
Dimension	105x65x20mm

**Amplifier for LED Strip
RGB - Iron Shell 3x8A**

SKU:	6326
Product Code	AC2-A2
Power	288W-576W
Voltage	12V-24V
IP Rating	IP20
Dimension	80x70x30mm

**Remote Control LED Strip
RGB - 16 Buttons 3x2A**

SKU:	6303
Product Code	AC2-A2
Power	72W
Voltage	12V
IP Rating	IP20
Dimension	50x35x20mm

**Amplifier for LED Strip
RGB+White 4x6A**

SKU:	6328
Product Code	AC2-A2
Power	288W-576W
Voltage	12V-24V
IP Rating	IP20
Dimension	65x55x20mm

**Remote Control LED Strip
RGB - 44 Buttons**

SKU:	6306	6307
Product Code	AC2-A2	AC2-A2
Power	72W	144W
Voltage	12V	12V
IP Rating	IP20	IP20
Dimension	50x35x20mm	50x35x20mm

**Amplifier for LED Strip
RGB 3x4A**

SKU:	6305
Product Code	AC2-A2
Power	144W-288W
Voltage	12V-24V
IP Rating	IP20
Dimension	80x55x20mm



**Remote Control LED Strip
RGB Touch White/Black 3x6A**

 DC:12V/24V
 IP20

SKU:	6314	6315
Product Code	AC2-A2	AC2-A2
Power	216W-432W	216W-432W
Voltage	12V / 24V	12V / 24V
Body Color	White	Black
Dimension	95x50x30mm	95x50x30mm

**Sensor Dimmer
Wall Mounted 10A**

SKU:	6318
Product Code	AC2-A2
Power	120W-240W
Voltage	12V / 24V
Body Color	Black
Dimension	85x85x40mm

IP20

**Remote Control LED Strip
RGBW Touch 4x6A**

 DC:12V/24V
 IP20

SKU:	6329
Product Code	AC2-A2
Power	288W-576W
Voltage	12V / 24V
IP Rating	IP20
Dimension	80x45x15mm

**Sensor Dimmer
Wall Mounted 10A**

SKU:	6320
Product Code	AC2-A2
Power	120W-240W
Voltage	12V / 24V
Body Color	White
Dimension	85x85x40mm

IP20

**Music LED Controller
With Remote Control 3x4A**

 DC:12V/24V
 IP20

SKU:	6312
Product Code	AC2-A2
Power	144W-288W
Voltage	12V-24V
IP Rating	IP20
Dimension	170x85x23mm

**Sensor Dimmer
Wall Mounted RGB 3x4A**

SKU:	6317
Product Code	AC2-A2
Power	144W-288W
Voltage	12V-24V
IP Rating	IP20
Dimension	85x85x40mm

IP20

**DMX512 Decoder
3x4A**

 DC:12V/24V
 IP20

SKU:	6308
Product Code	AC2-A2
Power	144W-288W
Voltage	12V-24V
IP Rating	IP20
Dimension	160x60x42mm

**Sensor Dimmer
Wall Mounted RGB 3x4A**

SKU:	6319
Product Code	AC2-A2
Power	144W-288W
Voltage	12V-24V
IP Rating	IP20
Dimension	85x85x40mm

IP20

**LED Remote Control Set
Single Color RF 2.4G 3CH 3x4A V3**
**LED Remote**

Output signal	RF 2.4GHz
Working voltage	3VDC(CR2032)
Standby time	12 months
Remote distance	30m
Dimension	107x58.5x9mm

LED Receiver

Input voltage	12/24VDC
Output power	144W/288W
Output current	3CH,4A/CH
IP Rating	IP20
Dimension	97x33x18mm

SKU: 6348 **Professional series**
**LED Remote Control Set
RGB - RF 2.4G 3CH 3x4A V3**
**LED Remote**

Output signal	RF 2.4GHz
Working voltage	3VDC(CR2032)
Standby time	12 months
Remote distance	30m
Dimension	107x58.5x9mm

LED Receiver

Input voltage	12/24VDC
Output power	144W/288W
Output current	3CH,4A/CH
IP Rating	IP20
Dimension	97x33x18mm

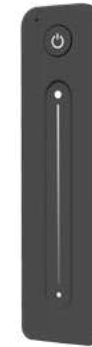
SKU: 6349 **Professional series**
**LED Single Color Remote Control
Touch - 1 Zone RF 2.4GHZ**

- * Match with OPTONICA Professional LED Controllers.
- * Ultra sensitive color adjustment touch slide.
- * Each remote can match one or more receivers.
- * Operate with LED indicator light.
- * Magnet on the back which can be easily stuck on any metal surfaces
- * CR2032 battery powered.

SKU: 6359 **Professional series**

IP20



Dimmable

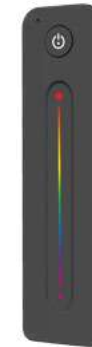

Battery

**LED RGB Remote Control
Touch - 1 Zone RF 2.4GHZ**

- * Match with OPTONICA Professional LED Controllers.
- * Ultra sensitive color adjustment touch slide.
- * Each remote can match one or more receivers.
- * Operate with LED indicator light.
- * Magnet on the back which can be easily stuck on any metal surfaces
- * CR2032 battery powered.

SKU: 6360 **Professional series**

IP20



Dimmable



Battery

**RGB+CCT LED Strip Controller Kit
5 channels constant voltage/Step-less dimming**

IP20

- * 5 Channels constant voltage output for RGB+ CCT light
- * Ultra sensitive color adjustment touch wheel
- * Smooth dimming and switch without any flickering
- * Built in 10 dynamic mode, include jump or gradual change style
- * Independent dimming function of each R, G, B channel to achieve millions of colors
- * Auto-transmitting function: Controller automatically transmit signal to another controller with 30m control distance
- * Synchronize on multiple number of controllers
- * Light on/off fade time 3s selectable

SKU: 6387 **Professional series**
**LED RGB + CCT Remote Control
Touch - 4 Zone RF 2.4GHZ**

- * Match with OPTONICA Professional LED Controllers.
- * Ultra sensitive color adjustment touch wheel.
- * Each remote can match one or more receivers.
- * Operate with LED indicator light.
- * AAx2 battery powered.
- * Dimension 122x53x17.5mm

SKU: 6368 **Professional series**

IP20



Dimmable



Battery

**Bluetooth & RF 2CH LED Controller
2 Channels/Push-Dim/Wireless control**

IP20

- * Remote control or connected with external push switch to achieve on/off and dimming function
- * Ultra sensitive brightness adjustment touch slide
- * Smooth dimming and switch without any flickering
- * Auto-transmitting function: Controller automatically transmit signal to another controller with 30m control distance
- * Synchronize on multiple number of controllers
- * Light on/off fade time 3s selectable
- * Magnet on the back which can be easily stuck on back holder or any metal surfaces

SKU: 6386 **Professional series**
**LED CCT Remote Control
Touch - 4 Zone RF 2.4GHZ**

- * Match with OPTONICA Professional LED Controllers.
- * Ultra sensitive color adjustment touch wheel.
- * Each remote can match one or more receivers.
- * Operate with LED indicator light.
- * AAx2 battery powered.
- * Dimension 122x53x17.5mm

SKU: 6350 **Professional series**

IP20



Dimmable



Battery

Wall Mounted Touch Panel
4 Zone/Color wheel/AC input/DMX 512 signal

Input Voltage	12-36VDC	Output Current	2CH,5A/CH
Input Current	10.5A	Output Power	2x(60-180)W
Output Voltage	2X(12-36)VDC	Output Type	Constant Voltage

- Used for control single color or color temperature LED strip.
- Tuya APP cloud control, support on/off, color temperature and brightness adjust, delay turn on/off light.
- Each controller can also work as Bluetooth-RF converter, then use Tuya APP to control one or more RF LED controller or RF LED dimming driver synchronously.

 SKU: 6376 Professional series

Wall Mounted Touch Panel
4 Zone/Color wheel/AC input/DMX 512 signal

Input Voltage	12-24VDC	Output Power	2x(60-180)W
Input Current	10.5A	Output Type	Constant Voltage
Output Voltage	2X(12-36)VDC		

- Used for control single color or color temperature LED strip.
- Tuya APP cloud control, support on/off, color temperature and brightness adjust, delay turn on/off light.
- Each controller can also work as Bluetooth-RF converter, then use Tuya APP to control one or more RF LED controller or RF LED dimming driver synchronously.

 SKU: 6377 Professional series

LED Remote Control
Single Color Touch - 2.4GHZ

- Touch panel 4 zone 1 color RF remote.
- Each zone can remote control multiple receivers, LED controller, dimming driver or smart lamp.
- Ultra sensitive high strength glass touch panel with touch color slide in the middle.
- Smooth and accurate adjustment by touching the slide.
- Touch keys with chord tones and LED indicator.
- Free installation, no wiring, removable.
- AAA x 2 battery powered.

 SKU: 6375 Professional series

LED Remote Control
RGB/RGBW Touch - 2.4GHZ

- Touch panel 4 zone 1 color RF remote.
- Each zone can remote control multiple receivers, LED controller, dimming driver or smart lamp.
- Ultra sensitive high strength glass touch panel with touch color slide in the middle.
- Smooth and accurate adjustment by touching the slide.
- Touch keys with chord tones and LED indicator.
- Free installation, no wiring, removable.
- AAA x 2 battery powered.

 SKU: 6374 Professional series

Ultra thin Touch Wheel RF Remote Controller
4 zone RGB+CCT/Touch color wheel

- Apply to RGB+CCT LED controller.
- Ultra sensitive color adjustment touch wheel.
- Each remote can match one or more receiver.
- CR2032 battery powered.
- Operate with LED indicator light.

 SKU: 6381 Professional series

Desk Mount RF Remote Controller
Rotary dimming/CR2032 battery

Output signal	RF(2.4GHz)	Standby current	<10μA
Working voltage	3VDC(CR2032)	Standby time	1 year
Working current	<5mA	Remote distance	30m

- Apply to RGB LED controller.
- Rotate knob to change RGB color, color temperature or brightness, support long press or twice click operation.
- Each remote can match one or more receiver.
- CR2032 battery powered.
- Desk mount, removable anywhere easily.

 SKU: 6379 Professional series

RF Signal Repeater
AC or DC input /Wall junction box mounting

Input Voltage	12-36VDC ; 100-240VAC
Input/Output	RF 2.4GHz
RF Control Distance	30m

- Apply for wireless signal extension, greatly ensures RF communication stability and wide controlling area.
- Powered by AC100-240V or DC12-24V.
- Compatibility with RF 2.4G remote control.
- Easy to be placed in standard wall junction box.

 SKU: 6382 Professional series

WiFi & RF AC Triac Dimmer
Voice control/RF dimming/Push Dim

Input Voltage	AC100-240V	Output Current	MAX 1.5A
Output Voltage	AC100-240V	Output Power	150-360W

- WiFi + RF + Push AC phase-cut dimmer, 1 channel output.
- Voice control, support amazon ECHO and TmallGenie smart speaker.
- 256 levels 0-100% dimming smoothly without any flash.
- Compatibility with RF 2.4G single zone or multiple zone dimming remote control.
- Easy to be placed in standard wall junction box behind a push switch.
- Over-heat / Over-load protection, recover automatically.

 SKU: 6388 Professional series

Bluetooth & RF 2CH LED Controller
2 Channels/Push-Dim/Wireless control

Input Voltage	12-36VDC	Output Current	2CH,5A/CH
Input Current	10.5A	Output Power	2x(60-180)W
Output Voltage	2X(12-36)VDC	Output Type	Constant Voltage

- Used for control single color or color temperature LED strip.
- Tuya APP cloud control, support on/off, color temperature and brightness adjust, delay turn on/off light.
- Each controller can also work as Bluetooth-RF converter, then use Tuya APP to control one or more RF LED controller or RF LED dimming driver synchronously.

SKU: 6384 *Professional series*
WiFi & RF 5 in1 LED Controller
Tuya APP cloud control/Voice control/5 Channels

Input Voltage	12-24VDC	Output Current	5CH,3A/CH
Input Current	15.5A	Output Power	5x(36-72)W
Output Voltage	5X(12-24)VDC	Output Type	Constant Voltage

- 5 in 1 function, used for control RGB, RGBW, RGB+CCT, color temperature or single color LED strip.
- Voice control, support amazon ECHO and TmallGenie smart speaker.
- Match with RF 2.4G remote control optional.
- Light on/off fade time 3s selectable.

SKU: 6383 *Professional series*
Constant Voltage LED Waterproof Controller
4 Channels/Wireless remote control/Synchronize

Input Voltage	12-36VDC	Output Current	4CH,5A/CH
Input Current	20.5A	Output Power	4x(60-180)W
Output Voltage	4X(12-36)VDC	Output Type	Constant Voltage

- When using with RGB/RGBW light, built in 10 dynamic mode, include jump or gradual change style.
- Auto-transmitting function: Controller automatically transmit signal to another controller with 30m control distance.
- Synchronize on multiple number of controllers.
- Fade in and out effect selectable.

SKU: 6380 *Professional series*
Constant Voltage Waterproof Power Repeater
4 Channel/PWM signal input

Input Voltage	12-36VDC	Output Current	4CH,5A/CH
Input Current	20.5A	Output Power	4x(60-180)W
Output Voltage	4X(12-36)VDC	Output Type	Constant Voltage

- Waterproof 12-36V constant voltage power repeater with IP67 rating, suitable for outdoor and damp environment.
- 4 channel, 5A per channel.
- To receive PWM signal control.
- Power repeater in series or in parallel to expand output unlimitedly.
- Apply to single color, dual color, RGB or RGBW constant voltage LED strip or module.

SKU: 6395 *Professional series*
6 Channel DMX Sliding Fader Console
6 Sliding Faders / Real DMX Value LED Screen

Ideal Cost Efficient 6 Channel Mini DMX Fader Console

- Easy Usage
- Suitable for permanent installations by using available brackets
- Ideal for Sample Testing and Trouble-Shooting on-site or workshops
- Powered by 3 x AAA Batteries or external 5-12V Power-Supply
- 3 Digit LED Screen 0-100% or DMX000-DMX255 (Settings by internal DIP-Switch)
- 6 Channel Mode or 5 Channel & Master Mode (Settings by internal DIP-Switch)

SKU: 6392 *Professional series*
Constant Voltage DMX512 & RDM Decoder
Linear or logarithmic dimming/Numeric display

Comply with the DMX512 standard protocols.

- Digital numeric display, set DMX decode start address by buttons.
- RDM function can realize intercommunication between DMX decoder address can be set by DMX master console.
- 1/2/4 DMX channel output selectable.
- 16bit (65536 levels) /8bit (256 levels) grey level selectable.
- Stand-alone RGB/RGBW mode and 4 channel dimmer mode selectable, which be controlled by buttons with built-in programs, instead of DMX signal.

SKU: 6390 *Professional series*
4 Ways DMX Signal Splitter
DMX512-A compatible

- One DMX512 signal input, repeat four DMX512 signal output, each allowing for 32 DMX devices to be connected.
- Dedicated to amplify, distribute and insulate the signal that comes from the lighting system equipment when it is connected to the bus of DMX512(or RS-485).
- Input isolated from outputs to 500VAC, 1000VDC.
- Outputs are isolated from each other to 500VAC, 1000VDC.
- Input and outputs are ture RS-485 rated, and no microprocessors are used for maximum reliability.

SKU: 6391 *Professional series*
Constant Voltage Power Repeater
5 Channel/PWM signal input/Constant voltage

- 12-24V constant voltage power repeater.
- 5 channel, 5A per channel.
- To receive PWM signal control.
- Power repeater in series or in parallel to expand output unlimitedly.
- Apply to RGB+CCT constant voltage LED strip or module.

SKU: 6396 *Professional series*

Constant Voltage Power Repeater
1 Channel/PWM signal input

IP20

Input Voltage	12-24VDC	Output Current	15A
Input Current	15.5A	Output Power	180-360W
Output Voltage	12-36VDC	Output Type	Constant Voltage

- 12-24V constant voltage power repeater.
- one channel, 15A.
- To receive PWM signal control.
- Power repeater in series or in parallel to expand output unlimitedly.
- Apply to single color constant voltage LED strip or module.

SKU: 6393 Professional series
PIR Sensor Stair Light Controller
PIR sensor/Daylight Sensor/Max 32 step

IP20

Input Voltage	5-24VDC	Output Current	32CH,1A/CH
Output Voltage	32 x (5-24)VDC	Output Power	32 x (5-24)W
Output Type	Constant Voltage+SPI(TTL)		

- Multiple function PIR sensor stair light controller with daylight sensor.
- 32 channels constant voltage output drive low voltage LED strip, Max. 1A
- Built-in multiple color mode, speed and brightness 1-8 grade adjustable.
- Push switch can also be as induction signal input.
- With fast self-testing function.
- Any damaged LED channel in 32 channels can be set disable.

SKU: 6385 Professional series
12-60V Constant Voltage Power Repeater
4 Channel/12-60V/PWM signal input

IP20

Input Voltage	12-60VDC	Output Current	4CH,5A/CH
Input Current	20A	Output Power	4x(60-300)W
Output Voltage	4X(12-60)VDC	Output Type	Constant Voltage

- 12-60V constant voltage power repeater.
- 3/4 channel, 5A max. per channel.
- To receive PWM signal control.
- Power repeater in series or in parallel to expand output unlimitedly.
- Apply to single color, dual color, RGB or RGBW constant voltage LED strip or module.

SKU: 6394 Professional series
RGB LED Mini Controller without remote
3 channel constant voltage/Max 4.5A output

IP20

Input Voltage	12-24VDC	Output Current	3CH,1.5A/CH
Output Voltage	12-24VDC	Output Type	Constant Voltage

- 3 channel constant voltage RGB LED mini controller.
- 3 key operation with on/off, mode and color adjustment.
- 1.5A per channel, output connect with 5 meters RGB LED strip.
- 256 levels 0-100% dimming smoothly without any flash.
- Built in 10 dynamic mode, include jump or gradual change style.

SKU: 6378 Professional series
Dimming High Voltage LED Strip Controller
3 Channels/Step-less dimming/Wireless control

IP20

Input Voltage	110-240VAC	Output Current	3CH,1A/CH
Input Current	3.2A	Output Power	3x(110-240)W
Output Voltage	3X(110-240)VDC		

- 3 channel high voltage LED strip RF 2.4G controller
- Match with RF 2.4G single zone or multiple zone single color, dual color and RGB/RGBW remote control.
- One RF controller accept up to 10 remote control.
- When using with RGB light, built in 10 dynamic mode, include jump or gradual change style.

SKU: 6397 Professional series
DMX512 /0-10V to Triac Dimmer
RDM/Stand-alone function/Numeric display/

IP20

Input Voltage	100-240VAC	Output Current	1CH,6A/CH
Output Voltage	100-240VAC	Output Power	600-1440)W

- AC phase-cut mosfet dimmer with DMX512 function, one channel output.
- Comply with the DMX512 standard protocols.
- Digital numeric display, set DMX decode start address by buttons.
- Reverse-phase dimming or forward-phase dimming selectable.
- Minimum brightness set from 1% to 40%.
- Stand-alone dynamic mode and dimmer mode selectable, which be controlled by buttons with built-in programs, instead of DMX signal.

SKU: 6389 Professional series

 Wall mounted holder for 6345
 SKU: 6347

LED RGB/RGBW Remote Control
4 Zone RF 2.4GHZ
Professional series

- * Match with OPTONICA Professional LED Controllers.
- * Ultra sensitive color adjustment touch wheel.
- * Each remote can match one or more receivers.
- * Operate with LED indicator light.
- * AAAx2 battery powered.
- * Dimension 122x53x17.5mm

SKU: 6345



IP20



Dimmable



Battery

LED Controller
3 Channel x 4A
Professional series

IP20

SKU:	6353	Output Voltage	3X(12-24)VDC
Product Code	AC2-A3	Output Current	3CH,4A/CH
Input Voltage	12-24VDC	Output Power	144/288W
Input Current	12.5A	Output Type	Constant Voltage
Input Signal	RF2.4Ghz	Dimension	96x33x17 mm

- * Match with OPTONICA Professional Series Remote Controls.
- * One RF controller accept up to 10 remote control.
- * Build in 10 dynamic mode, include jump or gradual change style.
- * Auto-transmitting function: Controller automatically transmit signal of another controller with 30m control distance.
- *Synchronize on multiple number of controllers.

 Remote Holder
 for all remotes
 SKU: 6334

LED RGB/RGBW Remote Control
4 Zone RF 2.4GHZ
Professional series

- * Match with OPTONICA Professional LED Controllers.
- * Ultra sensitive color adjustment touch wheel.
- * Each remote can match one or more receivers.
- * Slim and light
- * CR2032 battery powered.
- * Dimension 107x58.5x9mm

SKU: 6335



IP20



Dimmable



Battery

LED Controller
4 Channel x 5A
Professional series

IP20

SKU:	6342	Output Voltage	4x(12-36)VDC
Product Code	AC2-A3	Output Current	4CH,5A/CH
Input Voltage	12-36VDC	Output Power	4x(60-180)W
Input Current	20.5A	Output Type	Constant Voltage
Input Signal	RF2.4Ghz+Push	Dimension	175x45x27 mm

- * Match with OPTONICA Professional Series Remote Controls.
- * One RF controller accept up to 10 remote control.
- * Build in 10 dynamic mode, include jump or gradual change style.
- * Auto-transmitting function: Controller automatically transmit signal of another controller with 30m control distance.
- *Synchronize on multiple number of controllers.
- *Connect with external push switch to achieve on/off and dimming function.

 Wall mounted holder for 6341
 SKU: 6346

LED Remote Control
4 Zone Single Color RF 2.4GHZ
Professional series

- * Match with OPTONICA Professional LED Controllers.
- * Each remote can match one or more receivers.
- * Slim and light
- * IP20
- * CR2032 battery powered.
- * Dimension 135x40x11mm

SKU: 6341



IP20



Dimmable



Battery

LED Controller
4 Channel x 300mA Constant Current
Professional series

IP20

SKU:	6343	Output Voltage	4x(12-48)VDC
Product Code	AC2-A3	Output Current	4CH,300mA/CH
Input Voltage	12-48VDC	Output Power	4x(3.6-14.4)W
Input Current	1.5A	Output Type	Constant Current
Input Signal	RF2.4Ghz+Push	Dimension	175x45x27 mm

- * Match with OPTONICA Professional Series Remote Controls.
- * One RF controller accept up to 10 remote control.
- * Build in 10 dynamic mode, include jump or gradual change style.
- * Auto-transmitting function: Controller automatically transmit signal of another controller with 30m control distance.
- *Synchronize on multiple number of controllers.
- *Connect with external push switch to achieve on/off and dimming function.

 Wall mounted holder for 6340
 SKU: 6346

LED Remote Control
1 Zone CCT RF 2.4GHZ
Professional series

- * Match with OPTONICA Professional LED Controllers.
- * Each remote can match one or more receivers.
- * Slim and light.
- * IP20
- * CR2032 battery powered.
- * Dimension 107x58.5x9mm

SKU: 6340



IP20



Dimmable



Battery

**Smart Wifi-BLE Music Controller
IR 44 Keys RGB**

Input Voltage DC12-24V
 Output 3 Channels
 Output Current 2A (each channel)
 Output Power 12V-72W ; 24V-144W
 Dimension 70x30x15 mm

* Support remote/ local control through 2G / 3G /4G / Wi-Fi networks.

SKU: 6336



IP20



Dimmable



Battery

**Smart Wifi-BLE Controller
IR 24 Keys RGCCT**

Input Voltage DC12-24V
 Output 5 Channels
 Output Current 1A (each channel)
 Output Power 12V-60W ; 24V-120W
 Dimension 70x30x15 mm

* Support remote/ local control through 2G / 3G /4G / Wi-Fi networks.

SKU: 6337



IP20



Dimmable



Battery

**Smart Wifi-BLE Controller
IR 14 Keys CCT**

Input Voltage DC12-24V
 Output 2 Channels
 Output Current 2A (each channel)
 Output Power 12V-48W ; 24V-96W
 Dimension 70x30x15 mm

* Support remote/ local control through 2G / 3G /4G / Wi-Fi networks.

SKU: 6338



IP20



Dimmable



Battery

**LED Controller
IR 40 Keys RGBW**

Input Voltage DC12-24V
 Output 4 Channels
 Output Current 2A (each channel)
 Output Power 12V-96W ; 24V-192W
 Dimension 70x30x15 mm

* Support remote/ local control through 2G / 3G /4G / Wi-Fi networks.

SKU: 6339



IP20



Dimmable



Battery

**LED Controller
1 Channel x 8A**

Professional series

SKU: 6321
 Product Code AC2-A3
 Input Voltage 12-24VDC
 Input Current 8A
 Output Voltage 1X(12-24)VDC
 Output Current 8A/CH
 Output Power 96/384W
 Output Type Constant Voltage
 Dimension 97x33x18 mm

* Match with OPTONICA Professional Series Remote Controls.
 * Fade-in Fade-out LED dimmer with smooth fading effect for soft start and stop
 * The fading speed can be set via knob potentiometer, 1S, 3S, 5S, 10S, 20S selectable.
 * Connect with self-resetting metal button or push switch to achieve on/off and 0-100% dimming function.
 * Push input can accept either positive or negative trigger.



IP20

**LED Controller
1 Channel x 8A**

Professional series

SKU: 6322
 Product Code AC2-A3
 Input Voltage 5-36VDC
 Input Current 8.5A
 Output Voltage 1X(5-36)VDC
 Output Current 1CH,8A
 Output Power 40W/96W/192W/288W
 Output Type Constant Voltage
 Dimension 97x33x18 mm

* 4096 levels 0-100% dimming smoothly without any flash.
 * One RF controller accept up to 10 remote control.
 * Match with RF 2.4G single zone or multiple zone dimming remote control.
 * Auto-transmitting function: Controller automatically transmit signal to another controller with 30m control distance.
 * Synchronize on multiple number of controllers.



IP20

**LED Controller
1 Channel x 8A**

Professional series

SKU: 6352
 Input Voltage 5-25VDC
 Input Current 8A
 Input Signal Tuya App + RF 2.4Ghz
 Output Signal SPI(TTL)x2
 Dimension 120x43x27 mm

* Multi-pixel RGB/RGBW LED strip controller with SPI signal output, Tuya APP cloud control.
 * Voice control, support for Amazon ECHO, Google, Tmall Genie and Xiaodu smart speakers.
 * Compatible with 45 kinds of RGB or RGBW LED strips.
 * Rich dynamic effects: 44 default and 10+ custom dynamic scenarios, 16 variations.
 * Match with RF 2.4G RGB remote control.



IP20

DMX512 & RDM Decoder
4 Channel x 5A

Professional series



IP20



SKU:	6364	Output Voltage	12-24VDC
Product Code	AC2-A3	Output Current	4CH,5A/CH
Input Voltage	12-24VDC	Output Power	4x(60-120)W
Input Current	20.5A	Output Type	Constant Voltage
IP Rating	IP20	Dimension	170x50x24 mm

- * Match with OPTONICA Professional Series Remote Controls.
- * Comply with the DMX512 standard protocols.
- * Digital numeric display, set DMX address by buttons.
- * RDM function can realize intercommunication between DMX master and decoder.
- * 1/2/4 DMX channel output selectable.
- * Stand-alone RGB/RGBW mode and 4 channel dimmer mode selectable.

LED Dimmer
4 Channel x 5A

Professional series



IP20



SKU:	6369	Output Voltage	12-36VDC
Product Code	AC2-A3	Output Current	4CH,5A/CH
Input Voltage	12-36VDC	Output Power	4x(60-180)W
Input Current	20.5A	Output Type	Constant Voltage
Input Signal	0/1-10V+Push	Dimension	175x45x27 mm

- * Match with OPTONICA Professional Series Remote Controls.
- * 4 channel 0/1-10V LED dimming driver with push-dim function.
- * 4 channel 0/1-10V input, 4 channel PWM constant voltage output.
- * 0~100% dimming range via logarithmic characteristic can be very comfortable for human eyes.

LED Controller
5 Channel x 5A

Professional series



IP20



SKU:	6366	Output Voltage	5x(12-24)VDC
Product Code	AC2-A3	Output Current	5CH,5A/CH
Input Voltage	12-24VDC	Output Power	5x(60-120)W
Input Current	25.5A	Output Type	Constant Voltage
IP Rating	IP20	Dimension	175x45x27 mm

- * Match with OPTONICA Professional Series Remote Controls.
- * One RF controller accept up to 10 remote control.
- * Build in 10 dynamic mode, include jump or gradual change style.
- * Auto-transmitting function: Controller automatically transmit signal of another controller with 30m control distance.
- * Synchronize on multiple number of controllers.
- * Connect with external push switch to achieve on/off and dimming function.

DALI LED Dimmer
1 Channel 15A

Professional series



IP20



SKU:	6371	Output Voltage	12-24VDC
Product Code	AC2-A3	Output Current	1CH,15A
Input Voltage	12-24VDC	Output Power	180W/360W
Input Current	15A	Output Type	Constant Voltage
Input Signal	DALI+Push	Dimension	175x45x27 mm

- * Match with OPTONICA Professional Series Remote Controls.
- * Constant voltage DALI LED dimmer with 1 channel, 15A output.
- * DALI address will be automatically assigned by DALI master, 1 DALI address.
- * PWM digital dimming, standard DALI logarithmic dimming curve.
- * Connect with external push switch to achieve on/off and dimming function.

LED Dimmer
1 Channel 12A

Professional series



IP20



SKU:	6367	Output Voltage	12-36VDC
Product Code	AC2-A3	Output Current	1CH,12A
Input Voltage	12-36VDC	Output Power	144-432W
Input Current	12.5A	Output Type	Constant Voltage
Input Signal	0/1-10V+Push	Dimension	175x45x27 mm

- * Match with OPTONICA Professional Series Remote Controls.
- * 1 channel 0/1-10V LED dimming driver with push-dim function.
- * 1 channel 0/1-10V input, 1 channel PWM constant voltage output.
- * 0~100% dimming range via logarithmic characteristic can be very comfortable for human eyes.

DALI LED Dimmer
4 Channel x 5A

Professional series



IP20



SKU:	6372	Output Voltage	12-24VDC
Product Code	AC2-A3	Output Current	4CH,5A/CH
Input Voltage	12-24VDC	Output Power	4x(60-120)W
Input Current	20.5A	Output Type	Constant Voltage
Input Signal	DALI	Dimension	175x45x27 mm

- * Match with OPTONICA Professional Series Remote Controls.
- * 4 channel constant voltage DALI LED Dimmer, 5A per channel.
- * 4 DALI address, 4 channel work separately.
- * DALI address will be automatically assigned by DALI master.
- * PWM digital dimming, standard DALI logarithmic dimming curve.

LED Controller

Professional series



SKU:	6355	Output Voltage	4x(12-24)VDC
Product Code	AC2-A3	Output Current	4CH,5A/CH
Input Voltage	12-24VDC	Output Power	4x(60-120)W
Input Current	20.5A	Output Type	Constant Voltage
IP Rating	IP20	Dimension	110x64x45mm

- * Match with OPTONICA Professional Series Remote Controls.
- * Digital numeric display and easy key operation.
- * Can set as 1 channel dimmer, 4 channel, dual color, RGB or RGBW controller.
- * Logarithmic or linear dimming curve selectable.
- * Synchronize on multiple number of controllers.



IP20

AC Triac RF Dimmer

RF 2.4GHz + Push

Professional series



SKU:	6363	Output Voltage	100-240VAC
Product Code	AC2-A3	Output Current	MAX 1A
Input Voltage	100-240VAC	Output Power	100-240W
Input Signal	RF2.4GHz+Push	Dimming level	256 levels
IP Rating	IP20	Dimension	56x56x26 mm

- * Match with OPTONICA Professional Series Remote Controls.
- * RF+ Push AC phase-cut dimmer, 1channel output.
- * 0-100% dimming smoothly without any flash.
- * Connect with external push switch to achieve ON/OFF and dimming function.
- * Easy to be inserted into standard 86x86mm wall box



IP20

AC TRIAC Dimmer

Professional series



SKU:	6365	Output Voltage	100-240VAC
Product Code	AC2-A3	Output Current	1CH,2A/CH
Input Voltage	100-240VAC	Output Power	200-480W
Input Signal	RF2.4GHz+Push	Dimming level	100 levels
IP Rating	IP20	Dimension	110x64x45 mm

- * Match with OPTONICA Professional Series Remote Controls.
- * RF+ Push AC phase-cut dimmer, 1channel output.
- * Digital numeric display, set brightness by buttons.
- * 0-100% dimming smoothly without any flash.
- * Reverse-phase dimming or forward-phase dimming selectable.
- * Minimum brightness set from 1% to 40%



IP20

LED Controller

3 Channel x 10A

Professional series



SKU:	6356	Output Voltage	3x(12-36)VDC
Product Code	AC2-A3	Output Current	3CH,10A/CH
Input Voltage	12-36VDC	Output Power	3x(120-360)W
Input Current	30.5A	Output Type	Constant Current
Input Signal	RF2.4GHz	Dimension	105x75x25 mm

- * Match with OPTONICA Professional Series Remote Controls.
- * One RF controller accept up to 10 remote control.
- * Build in 10 dynamic mode, include jump or gradual change style.
- * Auto-transmitting function: Controller automatically transmit signal of another controller with 30m control distance.
- * Synchronize on multiple number of controllers.



IP20

Power Repeater

Professional series



SKU:	6370	Output Voltage	4x(12-24)VDC
Product Code	AC2-A3	Output Current	4CH,5A/CH
Input Voltage	12-24VDC	Output Power	4x(60-120)W
Input Current	20.5A	Output Type	Constant Voltage
IP Rating	IP20	Dimension	110x64x45 mm

- * Match with OPTONICA Professional Series Remote Controls.
- * To receive PWM signal control.
- * Power repeater in series or in parallel to expand output unlimitedly.
- * Apply to single color, dual color, RGB or RGBW constant voltage LED strip or module.
- * 3KV Optoelectronic isolation.



IP20

WiFi - Relay 2.4GHz

WiFi to RF Converter

Professional series



SKU:	6354	Output Control	RGB,RGBW,CT
Product Code	AC2-A3	Working Temp.	-20°C~50°C
Input Voltage	5-24VDC	Platform	iOS, Android
Wifi standard	802.11 b/g/n	Dimension	ø72x25 mm



IP20

NEW PRODUCT



LED 0-10V DIMMER

4 Zones - Touch glass panel

Professional series

SKU:	6398	Output Signal	0-10V (20mA)
Input Voltage	100-240V	Output Current	20mA/CH
IP Rating	IP20	Dimension	86x86x33 mm

- *Touch panel 0-10V dimmer, output 4 channel 0-10V signal
- * Output connect with 0/1-10V dimmable driver.
- * Ultra sensitive high strength glass touch panel with touch slide in the middle.
- * Compatibility with RF 2.4G dimming remote control.
- *Touch keys with LED indicator.



Dimmable



IP20

NEW PRODUCT



LED 0-10V DIMMER

1 Channel - Rotary glass panel

Professional series

SKU:	6399	Output Signal	0-10V (50mA)
Input Voltage	100-240V	Output Current	1.5A
IP Rating	IP20	Dimension	86x86x48 mm

- * Rotary glass panel 1-10V dimmer, 1 channel output.
- * Output connect with 0/1-10V dimmable driver.
- * Output 1 channel 1-10V signal, connect with 1-10V dimmable driver.
- * High voltage AC input, High voltage AC relay output.
- *Compatibility with RF 2.4G single zone or multiple zone dimming remote control.



Dimmable



IP20

NEW PRODUCT



LED AC TRIAC DIMMER

1 Channel - Rotary glass panel

Professional series

SKU:	6351	Output Power	150-360W
I/O Voltage	100-240V	Output Current	Max 1.5A
IP Rating	IP20	Dimension	86x86x48 mm

- * Rotary glass panel AC phase-cut dimmer, 1 channel output.
- * To dim and switch single color dimmable LED lamps, traditional incandescent and halogen lights.
- * 256 levels 0-100% dimming smoothly without any flash.
- * Leading edge dimming or trailing edge dimming set by dip switch.
- * Over-heat / Over-load protection, recover automatically.



Dimmable



IP20



LED Single Color Controller

4A*3CH

Professional series

SKU:	6357	Output Voltage	3x(12-24)VDC
Product Code	AC2-A3	Output Current	3CH,4A/CH
Input Voltage	12-24VDC	Output Power	144-288W
Input Current	12.5A	Output Type	Constant Voltage
IP Rating	IP20	Dimension	86x86x53 mm



Dimmable



IP20



LED RGB Controller

4A*3CH

Professional series

SKU:	6358	Output Voltage	3x(12-24)VDC
Product Code	AC2-A3	Output Current	3CH,4A/CH
Input Voltage	12-24VDC	Output Power	144-288W
Input Current	12.5A	Output Type	Constant Voltage
IP Rating	IP20	Dimension	86x86x53 mm



Dimmable



IP20



LED DMX Controller

4 Zones control DMX512+RF 2.4G

Professional series

SKU:	6361	Control Mode	4 Zone Control
Product Code	AC2-A3	Light Type	Single Color
Input Voltage	85-265V	Remote Distance	30m
Output Signal	DMX512+RF	Working Temp.	-20°C/+50°C
IP Rating	IP20	Dimension	86x86x36 mm



Dimmable



IP20



LED RGBW DMX Controller

4 Zones control DMX512+RF 2.4G

Professional series

SKU:	6362	Control Mode	4 Zone Control
Product Code	AC2-A3	Light Type	RGBW
Input Voltage	85-265V	Remote Distance	30m
Output Signal	DMX512+RF	Working Temp.	-20°C/+50°C
IP Rating	IP20	Dimension	86x86x36 mm



Dimmable



IP20

LED LINEAR AND TRACK LIGHTS



Highly specialized luminaires with concentrated light distribution angle intended for retail or other spot required presentation area. These adjustable fixtures can be combined with variously lengthen three phased tracks along with connectors to suit every design, including rapid solutions for trade fair halls and shopping malls.

Features:

- Three colour temperatures offered to match the needs of most commercial shelf products
- Upto 80% cost-saving use
- Quick and easy fool proof on and off installation

Application:

- Indoor use
- Any show-room, art gallery, dining rooms companions.
- Popular choice for both residential and commercial projects.

5
 Years
 Warranty

Linkable

**LED Linear Suspended Light
40W Slim Linkable**

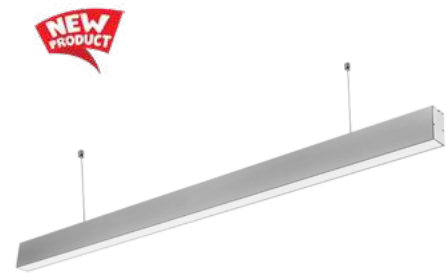
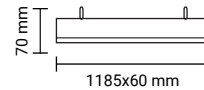

Product code	LN40-A3	CRI	Ra>80
Watts	40W	IP Rating	IP20
Input Voltage	AC : 200-240V	Dimension	1185x60x70 mm
Flux	4000lm	Body Color	BLACK
Beam Angle	120°	Dimmable	NO

 SKU: 5470 SKU: 5380
 6000K 4000K

5
 Years
 Warranty

Linkable

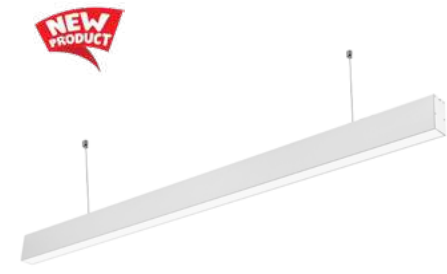
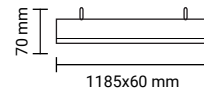
**LED Linear Suspended Light
40W Slim Linkable**



Product code	LN40-A3	CRI	Ra>80
Watts	40W	IP Rating	IP20
Input Voltage	AC : 200-240V	Dimension	1185x60x70 mm
Flux	4000lm	Body Color	SILVER
Beam Angle	120°	Dimmable	NO

 SKU: 5471 SKU: 5381
 6000K 4000K

5
 Years
 Warranty

Linkable

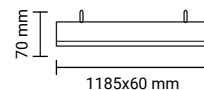
**LED Linear Suspended Light
40W Slim Linkable**

Product code	LN40-A3	CRI	Ra>80
Watts	40W	IP Rating	IP20
Input Voltage	AC : 200-240V	Dimension	1185x60x70 mm
Flux	4000lm	Body Color	WHITE
Beam Angle	120°	Dimmable	NO

 SKU: 5472 SKU: 5382
 6000K 4000K

5
 Years
 Warranty

**LED Linear L-Shape Connector
12W Slim Linkable**

Product code	LN10-A3	CRI	Ra>80
Watts	12W	IP Rating	IP20
Input Voltage	AC : 200-240V	Dimension	176x176x70 mm
Flux	1000lm	Body Shape	L-Shape
Beam Angle	120°	Dimmable	NO

 White Light 6000K

 SKU: 5060 Black Body
 SKU: 5061 Silver Body
 SKU: 5062 White Body

 Neutral White 4000K

 SKU: 5027 Black Body
 SKU: 5028 Silver Body
 SKU: 5029 White Body

5
 Years
 Warranty

**LED Linear T-Shape Connector
15W Slim Linkable**

Product code	LN15-A3	CRI	Ra>80
Watts	15W	IP Rating	IP20
Input Voltage	AC : 200-240V	Dimension	300x176x70 mm
Flux	1500lm	Body Shape	T-Shape
Beam Angle	120°	Dimmable	NO

 White Light 6000K

 SKU: 5063 Black Body
 SKU: 5064 Silver Body
 SKU: 5065 White Body

 Neutral White 4000K

 SKU: 5030 Black Body
 SKU: 5036 Silver Body
 SKU: 5037 White Body

5
 Years
 Warranty

**LED Linear X-Shape Connector
20W Slim Linkable**

Product code	LN20-A3	CRI	Ra>80
Watts	20W	IP Rating	IP20
Input Voltage	AC : 200-240V	Dimension	300x300x70 mm
Flux	2000lm	Body Shape	X-Shape
Beam Angle	120°	Dimmable	NO

 White Light 6000K

 SKU: 5066 Black Body
 SKU: 5067 Silver Body
 SKU: 5068 White Body

 Neutral White 4000K

 SKU: 5038 Black Body
 SKU: 5039 Silver Body
 SKU: 5040 White Body

LED Linear Suspended Light
50W UP-DOWN

Product code	LN50-A3	CRI	Ra>80
Watts	50W	IP Rating	IP20
Input Voltage	AC : 200-240V	Dimension	1185x28x68 mm
Flux	5000lm	Body Color	BLACK
Beam Angle	120°	Dimmable	NO

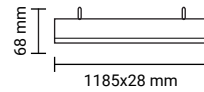

 SKU: 5383
 ■ 4000K

LED Linear Suspended Light
50W Linkable

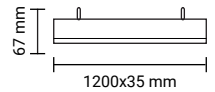
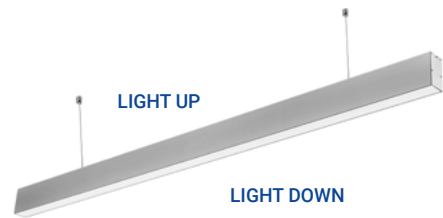
Product code	LN50-A4	CRI	Ra>80
Watts	50W	IP Rating	IP20
Input Voltage	AC : 200-240V	Dimension	1200x35x67 mm
Flux	4500lm	Body Color	BLACK
Beam Angle	60°	Dimmable	NO

 Connector
 SKU: 5047

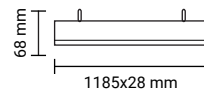
 SKU: 5386
 ■ 4000K

LED Linear Suspended Light
50W UP-DOWN

Product code	LN50-A3	CRI	Ra>80
Watts	50W	IP Rating	IP20
Input Voltage	AC : 200-240V	Dimension	1185x28x68 mm
Flux	5000lm	Body Color	SILVER
Beam Angle	120°	Dimmable	NO

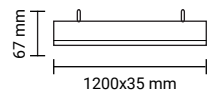
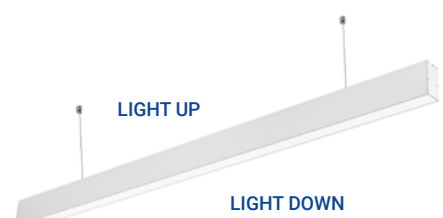

 SKU: 5384
 ■ 4000K

LED Linear Suspended Light
50W Linkable

Product code	LN50-A4	CRI	Ra>80
Watts	50W	IP Rating	IP20
Input Voltage	AC : 200-240V	Dimension	1200x35x67 mm
Flux	4500lm	Body Color	SILVER
Beam Angle	60°	Dimmable	NO

 Connector
 SKU: 5047

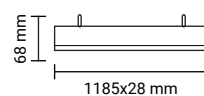
 SKU: 5387
 ■ 4000K

LED Linear Suspended Light
50W UP-DOWN

Product code	LN50-A3	CRI	Ra>80
Watts	50W	IP Rating	IP20
Input Voltage	AC : 200-240V	Dimension	1185x28x68 mm
Flux	5000lm	Body Color	WHITE
Beam Angle	120°	Dimmable	NO

 SKU: 5385
 ■ 4000K

LED Linear Suspended Light
50W Linkable

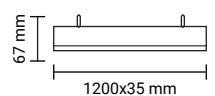

Product code	LN50-A4	CRI	Ra>80
Watts	50W	IP Rating	IP20
Input Voltage	AC : 200-240V	Dimension	1200x35x67 mm
Flux	4500lm	Body Color	WHITE
Beam Angle	60°	Dimmable	NO

 Connector
 SKU: 5047

 SKU: 5388
 ■ 4000K

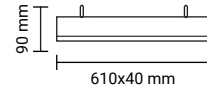

LED Wall washer for Tracks
30W For 3 Phase 4 Line Tracks

Product code	LN30-A3	CRI	Ra>80
Watts	30W	IP Rating	IP20
Input Voltage	AC : 200-240V	Dimension	610x40x90 mm
Flux	2700lm	Body Color	BLACK
Beam Angle	24°	Dimmable	NO

 SKU: 5389
 ■ 4000K

5
 Years
 Warranty

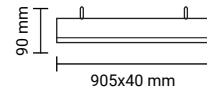
LED Wall washer for Tracks
40W For 3 Phase 4 Line Tracks

Product code	LN40-A4	CRI	Ra>80
Watts	40W	IP Rating	IP20
Input Voltage	AC : 200-240V	Dimension	9050x40x90 mm
Flux	3600lm	Body Color	BLACK
Beam Angle	24°	Dimmable	NO

 SKU: 5390
 ■ 4000K

5
 Years
 Warranty

LED COB Track Light
25W For 3 Phase 4 Line Tracks

3
 Years
 Warranty

2750
 Lumens

Product code	FL25-A1	CRI	Ra>80
Watts	25W	IP Rating	IP20
Input Voltage	AC : 220-240V	Dimension	ø80x145x160mm
Flux	2750lm	Body Color	WHITE
Beam Angle	24°		

SKU: 5321 ■ 5000K
 SKU: 5322 ■ 4500K
 SKU: 5323 ■ 3000K

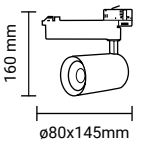

LED COB Track Light
25W For 3 Phase 4 Line Tracks

3
 Years
 Warranty

2750
 Lumens

Product code	FL25-A1	CRI	Ra>80
Watts	25W	IP Rating	IP20
Input Voltage	AC : 220-240V	Dimension	ø80x145x160mm
Flux	2750lm	Body Color	BLACK
Beam Angle	24°		

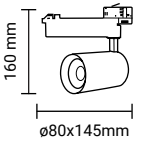
SKU: 5327 ■ 5000K
 SKU: 5328 ■ 4500K
 SKU: 5329 ■ 3000K



LED COB Track Light
35W For 3 Phase 4 Line Tracks

3
 Years
 Warranty

3850
 Lumens

Product code	WL35-A1	CRI	Ra>80
Watts	35W	IP Rating	IP20
Input Voltage	AC : 220-240V	Dimension	ø90x160x160mm
Flux	3850lm	Body Color	WHITE
Beam Angle	24°		

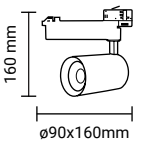
SKU: 5324 ■ 5000K
 SKU: 5325 ■ 4500K
 SKU: 5326 ■ 3000K

LED COB Track Light
35W For 3 Phase 4 Line Tracks

3
 Years
 Warranty

3850
 Lumens

Product code	WL35-A1	CRI	Ra>80
Watts	35W	IP Rating	IP20
Input Voltage	AC : 220-240V	Dimension	ø90x160x160mm
Flux	3850lm	Body Color	BLACK
Beam Angle	24°		

SKU: 5330 ■ 5000K
 SKU: 5331 ■ 4500K
 SKU: 5332 ■ 3000K



ACCESSORIES FOR TRACK LIGHTS



TRACK SYSTEM - 1M WHITE
SKU: 5153



TRACK SYSTEM - 1M BLACK
SKU: 5154



TRACK SYSTEM - 2M WHITE
SKU: 5156



TRACK SYSTEM - 2M BLACK
SKU: 5155



CONNECTOP ANGLE - WHITE
SKU: 5157



CONNECTOP LINE - BLACK
SKU: 5159



CONNECTOP ANGLE - WHITE
SKU: 5158



CONNECTOP ANGLE - BLACK
SKU: 5160



ACCESSORIES FOR 3-PHASE TRACK LIGHTS



TRACK SYSTEM 3PHASES - 1M WHITE
SKU: 5007



TRACK SYSTEM 3PHASES - 1M BLACK
SKU: 5009



TRACK SYSTEM 3PHASES - 2M WHITE
SKU: 5008



TRACK SYSTEM 3PHASES - 2M BLACK
SKU: 5010



STRAIGHT CONNECTOR WHITE
SKU: 5013



MINI STRAIGHT CONNECTOR WHITE
SKU: 5011



T-CONNECTOR WHITE
SKU: 5017



END CAP WHITE
SKU: 5023



STRAIGHT CONNECTOR BLACK
SKU: 5014



MINI STRAIGHT CONNECTOR BLACK
SKU: 5012



T-CONNECTOR BLACK
SKU: 5018



END CAP BLACK
SKU: 5024



L-FEEDER WHITE
SKU: 5019



L-CONNECTOR WHITE
SKU: 5015



X-CONNECTOR WHITE
SKU: 5021



FLEXIBLE CONNECTOR WHITE
SKU: 5025



L-FEEDER BLACK
SKU: 5020



L-CONNECTOR BLACK
SKU: 5016



X-CONNECTOR BLACK
SKU: 5022

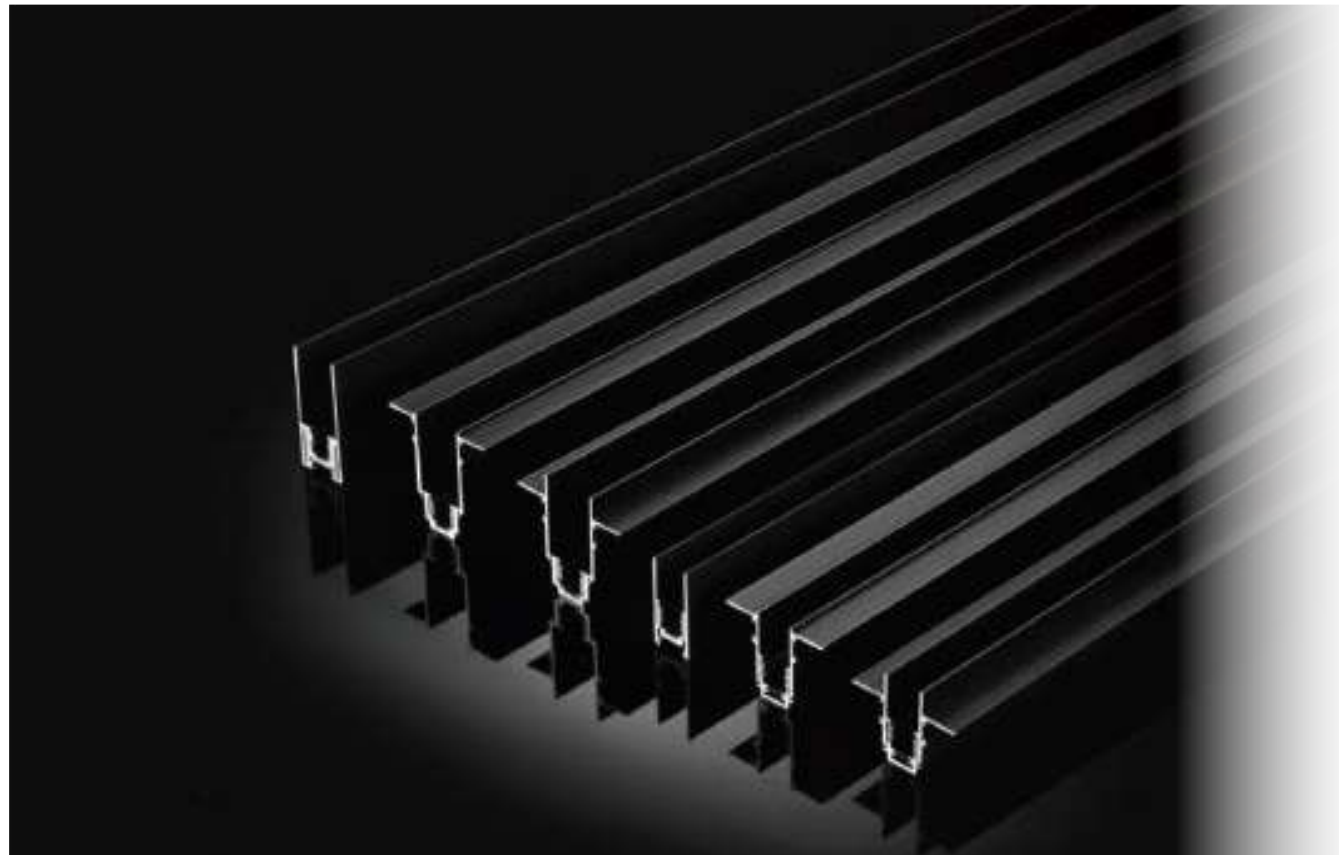

FLEXIBLE CONNECTOR BLACK
SKU: 5026

**NEW
PRODUCT**

MAGNETIC TRACK SERIES

Magnetic force connects profile and modules both mechanical and electrical.



Magnetic

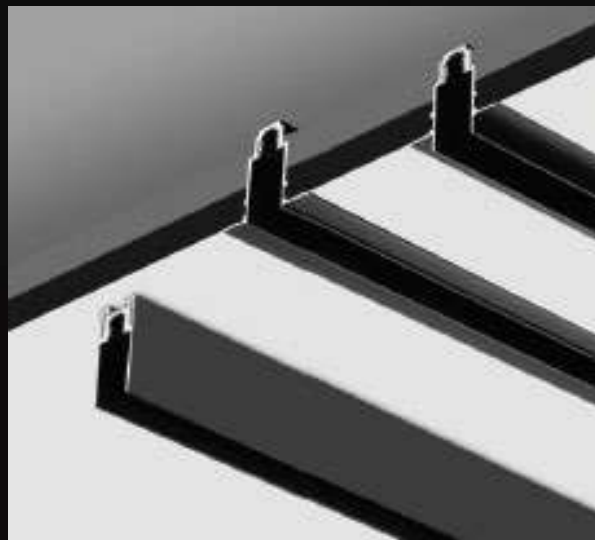

IP20

TRACK SYSTEM 3 PHASES R35

- SKU: 5350 BLACK BODY - 1m
 SKU: 5351 BLACK BODY - 1.5m
 SKU: 5352 BLACK BODY - 2m

 ANGLE CONNECTOR
 SKU: 5358

 END CAP
 SKU: 5353

Magnetic

TRACK SYSTEM 3 PHASES R35 Build-in

- SKU: 5360 BLACK BODY - 1m
 SKU: 5361 BLACK BODY - 1.5m
 SKU: 5362 BLACK BODY - 2m

 ANGLE CONNECTOR
 SKU: 5363

 END CAP
 SKU: 5411

Magnetic

TRACK SYSTEM 3 PHASES R35B-Build-in

- SKU: 5420 BLACK BODY - 1m
 SKU: 5421 BLACK BODY - 1.5m
 SKU: 5422 BLACK BODY - 2m

 ANGLE CONNECTOR
 SKU: 5423

 END CAP
 SKU: 5411

Magnetic

TRACK SYSTEM 3 PHASES S20

- SKU: 5364 BLACK BODY - 1m
 SKU: 5365 BLACK BODY - 1.5m
 SKU: 5366 BLACK BODY - 2m

 ANGLE CONNECTOR
 SKU: 5412

 END CAP
 SKU: 5413

Magnetic

TRACK SYSTEM 3 PHASES R20 Build-In

- SKU: 5367 BLACK BODY - 1m
 SKU: 5368 BLACK BODY - 1.5m
 SKU: 5369 BLACK BODY - 2m

 ANGLE CONNECTOR
 SKU: 5414

 END CAP
 SKU: 5415

Magnetic

TRACK SYSTEM 3 PHASES R20B-Build-in

- SKU: 5450 BLACK BODY - 1m
 SKU: 5451 BLACK BODY - 1.5m
 SKU: 5452 BLACK BODY - 2m

 ANGLE CONNECTOR
 SKU: 5453

 END CAP
 SKU: 5415

Magnetic



LED Magnetic Track Light
12W ; 20W

Product code	LN12-A4 ; LN20-A4	CRI	Ra>80
Power	12W ; 20W	IP Rating	IP20
Beam Angle	120°	Dimension 12W	300x34x50mm
Voltage	DC:48V	Dimension 20W	600x34x50mm



- SKU: 5340 12W 30cm 3000K
- SKU: 5391 12W 30cm 4000K
- SKU: 5341 20W 60cm 3000K
- SKU: 5392 20W 60cm 4000K



LED Magnetic Track Light
10W ; 20W

Product code	LN10-A4 ; LN20-A4	CRI	Ra>80
Power	10W ; 20W	IP Rating	IP20
Beam Angle	24°	Dimension 10W	135x34x95mm
Voltage	DC:48V	Dimension 20W	270x34x95mm



- SKU: 5347 10W 13.5cm 3000K
- SKU: 5398 10W 13.5cm 4000K
- SKU: 5348 20W 27cm 3000K
- SKU: 5399 20W 27cm 4000K



LED Magnetic Track Light
10W ; 20W

Product code	LN10-A4 ; LN20-A4	CRI	Ra>80
Power	10W ; 20W	IP Rating	IP20
Beam Angle	24°	Dimension 10W	135x34x50mm
Voltage	DC:48V	Dimension 18W	270x34x50mm



- SKU: 5342 10W 13.5cm 3000K
- SKU: 5393 10W 13.5cm 4000K
- SKU: 5343 20W 27cm 3000K
- SKU: 5394 20W 27cm 4000K



LED Magnetic Track Light
7W Focusing Spot Light

Product code	LN7-A4	Beam Angle	15-60°
Watts	7W	CRI	Ra>90
Input Voltage	48V	IP Rating	IP20
Flux	560lm	Dimension	Φ60x200mm



- SKU: 5349 Warm White 3000K
- SKU: 5400 Neutral White 4000K



**LED Magnetic Track Light
7W**

M35

TRACK



Magnetic



IP20

Product code LN7-A4
Watts 7W
Input Voltage 48V
Flux 560lm
Beam Angle 15°

CRI Ra>90
IP Rating IP20
Dimension ϕ 55x105mm
Body Color Black

SKU: 5395 SKU: 5344
4000K 3000K

**Power Supplies for Track Light
BUILT-IN 48V Output**

DC:48V



SKU: 5424 100W - 48V
SKU: 5425 200W - 48V
SKU: 5426 100W - 48V
SKU: 5427 200W - 48V
SKU: 5428 280W - 48V

Watts	100W	200W	100W	200W	280W
Input Voltage	220V	220V	220V	220V	220V
Output Voltage	DC: 48V	DC: 48V	DC: 48V	DC: 48V	DC: 48V
Current	2.1A	4.2A	2.1A	4.2A	5.85A
Material	PC	PC	PC	PC	PC
IP Rating	IP20	IP20	IP20	IP20	IP20
Dimension	190x90x30mm	220x120x30mm	220x120x30mm	220x120x30mm	220x120x30mm

Magnetic Track Light

M20

TRACK

M20

TRACK

M35

TRACK

M35

TRACK

M35

TRACK



**LED Magnetic Track Light
12W**

M35

TRACK



Magnetic



IP20

Product code LN12-A4
Watts 12W
Input Voltage 48V
Flux 960lm
Beam Angle 15°

CRI Ra>90
IP Rating IP20
Dimension ϕ 65x130mm
Body Color Black

SKU: 5396 SKU: 5345
4000K 3000K



**LED Magnetic Track Light
20W**

M35

TRACK



Magnetic



IP20

Product code LN20-A4
Watts 20W
Input Voltage 48V
Flux 1600lm
Beam Angle 15°

CRI Ra>90
IP Rating IP20
Dimension ϕ 65x130mm
Body Color Black

SKU: 5397 SKU: 5346
4000K 3000K





800
Lumens



1440
Lumens

LED Magnetic Track Light - M20
10W ; 18W

M20
TRACK
Magnetic
IP20

Product code	LN10-A4 ; LN18-A4	CRI	Ra>80
Power	10W ;18W	IP Rating	IP20
Beam Angle	120°	Dimension 10W	300x22x25mm
Voltage	DC:48V	Dimension 18W	600x22x25mm

SKU: 5417	10W 30cm	3000K
SKU: 5416	10W 30cm	4000K
SKU: 5419	18W 60cm	3000K
SKU: 5418	18W 60cm	4000K



CRI
90+

LED Magnetic Track Light
12W

M20
TRACK
Magnetic
IP20

Watts	12W	CRI	Ra>90
Input Voltage	DC48V	IP Rating	IP20
Flux	960lm	Dimension	Φ65x130mm
Beam Angle	15°	Body Color	Black

SKU: 5316	Warm White	3000K
SKU: 5315	Neutral White	4000K



CRI
90+

LED Magnetic Track Light
10W

M20
TRACK
Magnetic
IP20

Watts	10W	CRI	Ra>90
Input Voltage	DC48V	IP Rating	IP20
Flux	800lm	Dimension	Φ70x100mm
Beam Angle	15-24°	Body Color	Black

SKU: 5379	Warm White	3000K
SKU: 5378	Neutral White	4000K



480
Lumens



960
Lumens

LED Magnetic Track Light - M20
6W ; 12W

M20
TRACK
Magnetic
IP20

Product code	LN6-A4 ; LN12-A4	CRI	Ra>80
Power	6W ;12W	IP Rating	IP20
Beam Angle	24°	Dimension 10W	112x22x45mm
Voltage	DC:48V	Dimension 18W	220x22x45mm

SKU: 5312	6W	3000K
SKU: 5311	6W	4000K
SKU: 5314	12W	3000K
SKU: 5313	12W	4000K



Straight Joint

SKU: 5356



Joining Cable

SKU: 5357



Input Cable

SKU: 5355



Hanging Accessories

SKU: 5354



LED Magnetic Track Light 9W

720
Lumens

M20
TRACK

45°

Magnetic

IP20

Product code LN9-A4
Power 9W
Beam Angle 24°
Voltage DC:48V

CRI Ra>80
IP Rating IP20
Dimension 137x34x95mm

SKU: 5318 Warm White 3000K
SKU: 5317 Neutral White 4000K



LED Magnetic Track Light 5W

560
Lumens

M20
TRACK

Magnetic

IP20

Product code LN5-A4
Power 5W
Beam Angle 15-60°
Voltage DC:48V

CRI Ra>80
IP Rating IP20
Dimension Φ 60*200mm

SKU: 5319 Warm White 3000K
SKU: 5320 Neutral White 4000K



LED Magnetic Track Light 6W

480
Lumens

Magnetic

IP20

Product code LN6-A5
Watts 6W
Input Voltage DC48V
Flux 480lm
Beam Angle 90°

CRI Ra>80
IP Rating IP20
Dimension ϕ 130mm
Body Color Black

SKU: 5335 Neutral White 4000K
SKU: 5334 Warm White 3000K

M20
M35
TRACK



LED Magnetic Track Light 10W

800
Lumens

Magnetic

IP20

Product code LN10-A5
Watts 10W
Input Voltage DC48V
Flux 800lm
Beam Angle 90°

CRI Ra>80
IP Rating IP20
Dimension ϕ 85mm
Body Color Black

SKU: 5337 Neutral White 4000K
SKU: 5336 Warm White 3000K

M20
M35
TRACK



LED Magnetic Track Light 5W

400
Lumens

Magnetic

IP20

Product code LN5-A5
Watts 5W
Input Voltage DC48V
Flux 400lm
Beam Angle 50°

CRI Ra>80
IP Rating IP20
Dimension 88x75mm
Body Color Black

SKU: 5339 Neutral White 4000K
SKU: 5338 Warm White 3000K

M20
M35
TRACK



TRACK SYSTEM Three-Phase

WHITE**Length: 1.0m ; 1.5m ; 2.0m****S35**

SKU: 5241 WHITE BODY - 1m
 SKU: 5242 WHITE BODY - 1.5m
 SKU: 5243 WHITE BODY - 2m

R35 Build-in

SKU: 5250 WHITE BODY - 1m
 SKU: 5251 WHITE BODY - 1.5m
 SKU: 5252 WHITE BODY - 2m

R35B Build-in

SKU: 5255 WHITE BODY - 1m
 SKU: 5256 WHITE BODY - 1.5m
 SKU: 5257 WHITE BODY - 2m

**Accessories:**

INPUT CABLE
 SKU: 5246



STRAIGHT JOINT
 SKU: 5247



JOINING CABLE
 SKU: 5248



COVER PLATE
 SKU: 5254



S35 SURFACE CORNER
 SKU: 5249



R35 SURFACE CORNER
 SKU: 5253



R35-B SURFACE CORNER
 SKU: 5258



R35-A Concave Angle
 SKU: 5259



SLIM POWER SUPPLY 48V
100W 2.08A

M35
 TRACK



Watts	100W	Current	2.08A
Input Voltage	220V	Material	Metal
Output Voltage	DC: 48V	IP Rating	IP20

SKU: 5216 WHITE BODY



SLIM POWER SUPPLY 48V
200W 4.16A

M35
 TRACK



Watts	200W	Current	4.16A
Input Voltage	220V	Material	Metal
Output Voltage	DC: 48V	IP Rating	IP20

SKU: 5217 WHITE BODY



NEW
PRODUCT
**LED Magnetic Track Light
12W**

Watts 12W
 Input Voltage DC48V
 Flux 960lm
 Beam Angle 120°

SKU: 5265 SKU: 5261
 4000K 3000K



CRI Ra>90
 IP Rating IP20
 Dimension 300x34x50.5mm
 Body Color White

NEW
PRODUCT
**LED Magnetic Track Light
20W**

Watts 20W
 Input Voltage DC48V
 Flux 1600lm
 Beam Angle 120°

SKU: 5266 SKU: 5262
 4000K 3000K



CRI Ra>90
 IP Rating IP20
 Dimension 600x34x50.5mm
 Body Color White

NEW
PRODUCT
**LED Magnetic Track Light
10W**

Watts 10W
 Input Voltage DC48V
 Flux 800lm
 Beam Angle 90°

SKU: 5268 SKU: 5267
 4000K 3000K

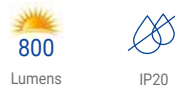

CRI Ra>90
 IP Rating IP20
 Dimension 134x34x50.5mm
 Body Color White

NEW
PRODUCT
**LED Magnetic Track Light
20W**

Watts 20W
 Input Voltage DC48V
 Flux 1600lm
 Beam Angle 120°

SKU: 5270 SKU: 5269
 4000K 3000K

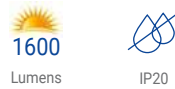

CRI Ra>90
 IP Rating IP20
 Dimension 270x34x50.5mm
 Body Color White

NEW
PRODUCT
**LED Magnetic Track Light
12W**

Watts 12W
 Input Voltage DC48V
 Flux 960lm
 Beam Angle 90°

SKU: 5271 SKU: 5263
 4000K 3000K



CRI Ra>90
 IP Rating IP20
 Dimension Φ65x130
 Body Color White

NEW
PRODUCT
**LED Magnetic Track Light
20W**

Watts 20W
 Input Voltage DC48V
 Flux 1600lm
 Beam Angle 90°

SKU: 5272 SKU: 5264
 4000K 3000K

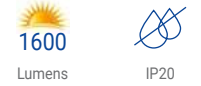

CRI Ra>90
 IP Rating IP20
 Dimension Φ65x130
 Body Color White

NEW
PRODUCT
**LED Magnetic Track Light
10W**

Watts 10W
 Input Voltage DC48V
 Flux 800lm
 Beam Angle 24°

SKU: 5273
 3000K

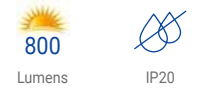

CRI Ra>90
 IP Rating IP20
 Dimension 137x34x95
 Body Color White



45°



NEW PRODUCT

TRACK SYSTEM Three-Phase

BLACK

Length: 1.0m ; 1.5m ; 2.0m

S15

- SKU: 5207 BLACK BODY - 1m
- SKU: 5208 BLACK BODY - 1.5m
- SKU: 5209 BLACK BODY - 2m

R15 Build-in

- SKU: 5204 BLACK BODY - 1m
- SKU: 5205 BLACK BODY - 1.5m
- SKU: 5206 BLACK BODY - 2m

R15B Build-in

- SKU: 5201 BLACK BODY - 1m
- SKU: 5202 BLACK BODY - 1.5m
- SKU: 5203 BLACK BODY - 2m



ACCESSORIES:



POWER CONNECTOR
SKU: 5211



STRAIGHT CONNECTOR
SKU: 5212



ADJUSTABLE CONNECTOR
SKU: 5213

SLIM POWER SUPPLY 48V - BLACK



SKU: 5214
80W 1.66A

Watts	80W	Current	1.66A
Input Voltage	220V	Material	Metal
Output Voltage	DC: 48V	IP Rating	IP20



SKU: 5215
150W 3.12A

Watts	150W	Current	3.12A
Input Voltage	220V	Material	Metal
Output Voltage	DC: 48V	IP Rating	IP20

NEW PRODUCT



LED Magnetic Track Light
6W ; 10W

M15
TRACK



Watts	6W ; 10W	CRI	Ra>90
Input Voltage	DC48V	IP Rating	IP20
Flux	480 ; 800lm	Dimension	φ35x70 mm
Beam Angle	90°	Body Color	Black

480 Lumens **6W** SKU: 5221 4000K SKU: 5222 3000K

800 Lumens **10W** SKU: 5223 4000K SKU: 5224 3000K

NEW PRODUCT



LED Magnetic Track Light
10W ; 20W

M15
TRACK



Watts	10W ; 20W	CRI	Ra>90
Input Voltage	DC48V	IP Rating	IP20
Flux	650 ; 1300lm	Dimension 10W	300x15x18mm
Beam Angle	120°	Dimension 20W	600x15x18mm

650 Lumens **10W** SKU: 5225 4000K SKU: 5226 3000K

1300 Lumens **20W** SKU: 5227 4000K SKU: 5228 3000K

NEW PRODUCT



LED Magnetic Track Light
12W

M15
TRACK



Watts	12W	CRI	Ra>90
Input Voltage	DC48V	IP Rating	IP20
Flux	780lm	Dimension	232x15x18mm
Beam Angle	24°	Body Color	Black

780 Lumens **12W** SKU: 5229 4000K SKU: 5230 3000K

MINI MAGNETIC TRACK SYSTEM
BLACK - 30mm
Length: 1.0m ; 1.5m ; 2.0m
MM30

SKU: 5480 BLACK BODY - 1m

SKU: 5481 BLACK BODY - 1.5m

SKU: 5482 BLACK BODY - 2m



Magnetic

IP20

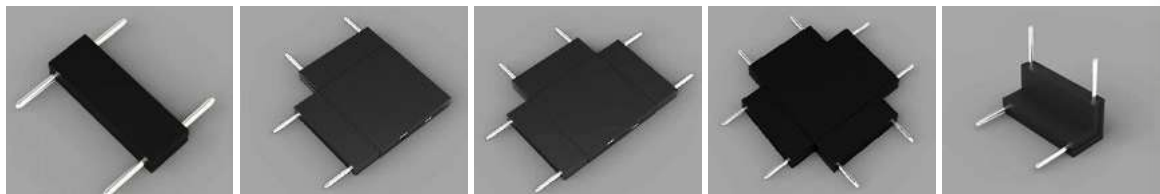
ACCESSORIES:

SKU: 5483

SKU: 5484

SKU: 5485

SKU: 5486

SKU: 5487

SLIM POWER SUPPLY 48V

Magnetic

IP20

SKU: 5488 100W 2.08A

Watts 100W

Input Voltage 220V

Output Voltage DC: 48V

Current 2.08A

Material Aluminium

IP Rating IP20

SKU: 5489 200W 2.08A

Watts 200W

Input Voltage 220V

Output Voltage DC: 48V

Current 4.16A

Material Aluminium

IP Rating IP20

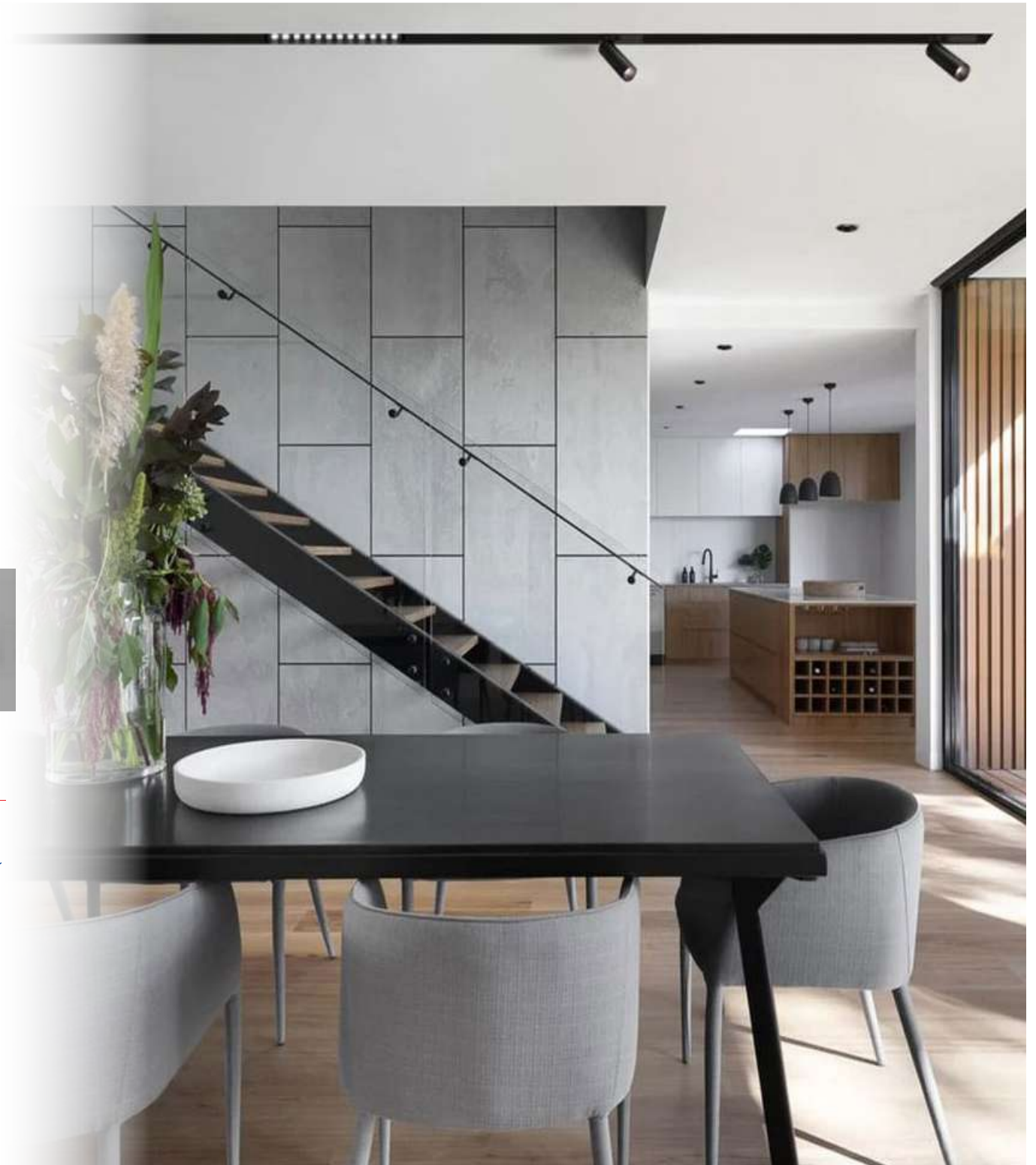



**LED Mini Magnetic Track Light
6W**



Watts	6W	CRI	Ra>90
Input Voltage	DC48V	IP Rating	IP20
Flux	720lm	Dimension	φ54x63x98mm
Beam Angle	32°	Body Color	Black

SKU: 5494 SKU: 5495
■ 4000K ■ 3000K



MM30
TRACK



**LED Mini Magnetic Track Light
5W**



Watts	5W	CRI	Ra>90
Input Voltage	DC48V	IP Rating	IP20
Flux	425lm	Dimension	48x35x60mm
Beam Angle	38°	Body Color	Black

SKU: 5496 SKU: 5497
■ 4000K ■ 3000K



MM30
TRACK



**LED Mini Magnetic Track Light
4W**



Watts	4W	CRI	Ra>90
Input Voltage	DC48V	IP Rating	IP20
Flux	240lm	Dimension	48x35x60mm
Beam Angle	80°	Body Color	Black

SKU: 5498 SKU: 5499
■ 4000K ■ 3000K



MM30
TRACK



**LED Mini Magnetic Track Light
12W**



Watts	12W	CRI	Ra>90
Input Voltage	DC48V	IP Rating	IP20
Flux	400lm	Dimension	300x32x11mm
Beam Angle	110°	Body Color	Black

SKU: 5490 SKU: 5491
■ 4000K ■ 3000K



MM30
TRACK



**LED Mini Magnetic Track Light
10W**



Watts	10W	CRI	Ra>90
Input Voltage	DC48V	IP Rating	IP20
Flux	520lm	Dimension	240x32x11mm
Beam Angle	25°	Body Color	Black

SKU: 5492 SKU: 5493
■ 4000K ■ 3000K



MM30
TRACK





LED Floodlights are commonly used for outdoor lighting large areas. Applicable for villas and country houses, LED floodlights are number one choice for gardens and large open spaces.

Features:

- Up to 80% power saving
- High power and IP65 rating
- Large beam angles for single product lighting
- Wall or pylon mountable
- Tough and reliable
- Options with solar panels

Application:

- Outdoor lighting
- Large area coverage
- Houses or warehouse usage

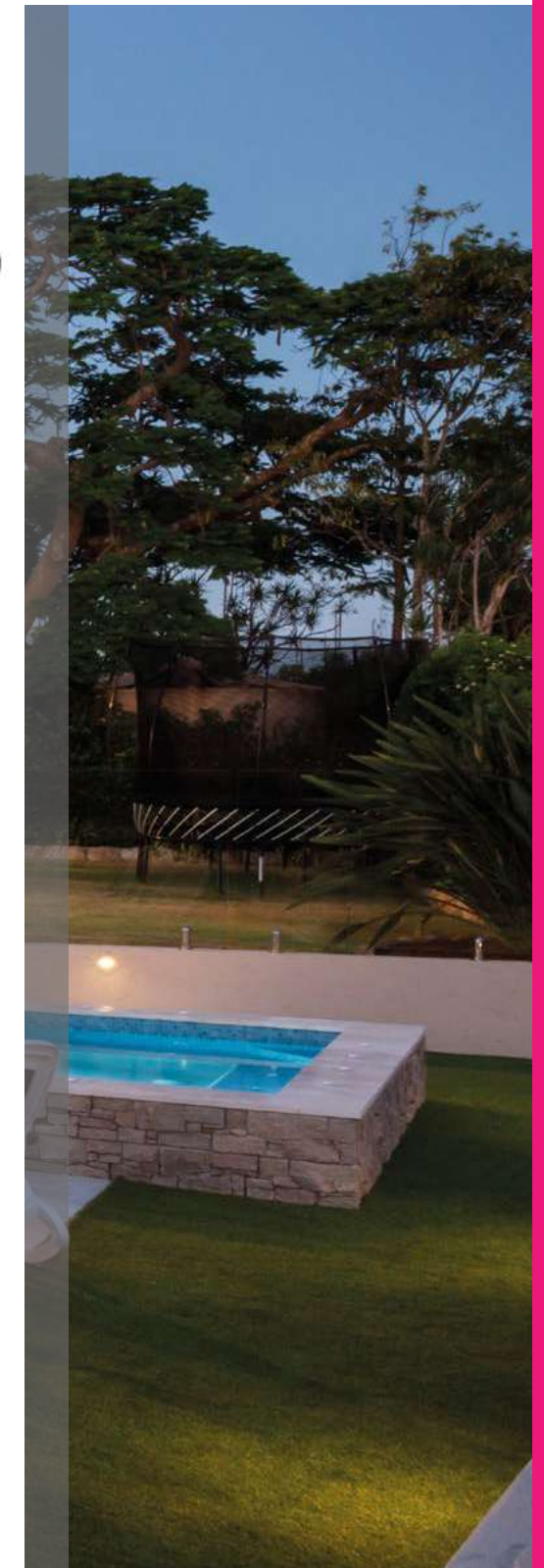

LED FLOODLIGHTS

LED FLOODLIGHTS



LED CCT SOLAR FLOODLIGHT
Solar Panel Power:5V/10W

1000 Lumens 120° IP65

EQ.Watts	10W	Beam Angle	120°
Battery	3.2V / 10Ah	CRI	Ra>80
Flux	1000lm	IP Rating	IP65

SKU: 5473
CCT
6000K 4500K 3000K

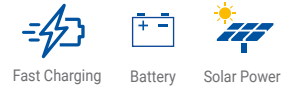

LED CCT SOLAR FLOODLIGHT
Solar Panel Power:5V/20W

1800 Lumens 120° IP65

EQ.Watts	10W	Beam Angle	120°
Battery	3.2V / 20Ah	CRI	Ra>80
Flux	1800lm	IP Rating	IP65

SKU: 5474
CCT
6000K 4500K 3000K

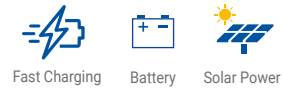

LED CCT SOLAR FLOODLIGHT
Solar Panel Power:5V/30W

2700 Lumens 120° IP65

EQ.Watts	30W	Beam Angle	120°
Battery	3.2V / 30Ah	CRI	Ra>80
Flux	2700lm	IP Rating	IP65

SKU: 5475
CCT
6000K 4500K 3000K

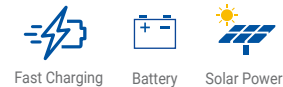

LED SMD SOLAR FLOODLIGHT
Solar Panel Power:6V/30W

3000 Lumens 120° IP65

EQ.Watts	30W	Beam Angle	120°
Battery	3.2V / 30Ah	CRI	Ra>80
Flux	3000lm	IP Rating	IP65

SKU: 5468
6000K



LED SMD SOLAR FLOODLIGHT
Solar Panel Power:6V/8W

500 Lumens 120° IP65

EQ.Watts	16W	Beam Angle	120°
Battery	3.2V / 5Ah	CRI	Ra>80
Flux	500lm	IP Rating	IP65

SKU: 5430
6000K

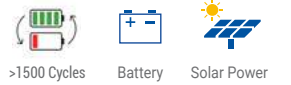

LED SMD SOLAR FLOODLIGHT
Solar Panel Power:6V/16W

1200 Lumens 120° IP65

EQ.Watts	16W	Beam Angle	120°
Battery	3.2V / 10Ah	CRI	Ra>80
Flux	1200lm	IP Rating	IP65

SKU: 5431
6000K



LED SMD SOLAR FLOODLIGHT
Solar Panel Power:6V/20W

1600 Lumens 120° IP65

EQ.Watts	20W	Beam Angle	120°
Battery	3.2V / 15Ah	CRI	Ra>80
Flux	1600lm	IP Rating	IP65

SKU: 5432
6000K



LED SMD SOLAR FLOODLIGHT
Solar Panel Power:6V/25W

2200 Lumens 120° IP65

EQ.Watts	25W	Beam Angle	120°
Battery	3.2V / 20Ah	CRI	Ra>80
Flux	2200lm	IP Rating	IP65

SKU: 5433
6000K





LED SOLAR POWER FLOOD LIGHT PF>0.9 with Solar Panel and Remote



6W EQ.Watts	800 Lumens	Solar Panel Flux	6W/5V 800lm	IP Rating	IP65	Body Color	Black	3.2V 6Ah	SKU: 5291	6000K
10W EQ.Watts	1200 Lumens	Solar Panel Flux	10W/5V 1200lm	IP Rating	IP65	Body Color	Black	3.2V 10Ah	SKU: 5292	6000K
15W EQ.Watts	2000 Lumens	Solar Panel Flux	15W/5V 2000lm	IP Rating	IP65	Body Color	Black	3.2V 15Ah	SKU: 5293	6000K
20W EQ.Watts	2600 Lumens	Solar Panel Flux	20W/5V 2600lm	IP Rating	IP65	Body Color	Black	3.2V 20Ah	SKU: 5294	6000K
25W EQ.Watts	3200 Lumens	Solar Panel Flux	25W/5V 3200lm	IP Rating	IP65	Body Color	Black	3.2V 25Ah	SKU: 5295	6000K
30W EQ.Watts	3800 Lumens	Solar Panel Flux	30W/5V 3800lm	IP Rating	IP65	Body Color	Black	3.2V 30Ah	SKU: 5296	6000K
40W EQ.Watts	4800 Lumens	Solar Panel Flux	40W/5V 4800lm	IP Rating	IP65	Body Color	Black	3.2V 40Ah	SKU: 5297	6000K



LED SMD FLOODLIGHT PF>0.9 with Solar Panels and Remote Control



900 Lumens	Product code	FL12-A6	Beam Angle	120°		SKU: 5465	6000K
	EQ.Watts	50W	CRI	Ra>80			
	Battery	3.2V / 11Ah	IP Rating	IP65			
	Flux	900lm	Body Color	Black			
2500 Lumens	Product code	FL35-A6	Beam Angle	120°		SKU: 5466	6000K
	EQ.Watts	100W	CRI	Ra>80			
	Battery	6.4V / 16.5Ah	IP Rating	IP65			
	Flux	2500lm	Body Color	Black			
3200 Lumens	Product code	FL40-A6	Beam Angle	120°		SKU: 5467	6000K
	EQ.Watts	150W	CRI	Ra>80			
	Battery	6.4V / 22Ah	IP Rating	IP65			
	Flux	3200lm	Body Color	Black			



LED SMD FLOODLIGHT **PF>0.9**
With Solar Panels and Remote Control



800
Lumens

Product code FL25-A6
EQ.Watts 12W
Battery 3.2V / 5.5Ah
Flux 800lm
Beam Angle 120°
CRI Ra>80
IP Rating IP65
Body Color Black

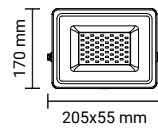

SKU: 5460
6000K

1300
Lumens

Product code FL40-A6
EQ.Watts 40W
Battery 3.2V / 11Ah
Flux 1300lm
Beam Angle 120°
CRI Ra>80
IP Rating IP65
Body Color Black

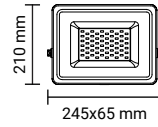

SKU: 5461
6000K

1800
Lumens

Product code FL60-B2
EQ.Watts 20W
Battery 6.4V / 11Ah
Flux 1800lm
Beam Angle 120°
CRI Ra>80
IP Rating IP65
Body Color Black

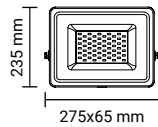

SKU: 5462
6000K

2500
Lumens

Product code FL100-B2
EQ.Watts 35W
Battery 6.4V / 16.5Ah
Flux 2500lm
Beam Angle 120°
CRI Ra>80
IP Rating IP65
Body Color Black

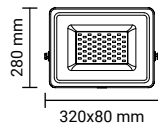

SKU: 5463
6000K



LED SMD FLOODLIGHT **PF>0.9**
With Solar Panels and Remote Control



400
Lumens

Product code FL6-B5
EQ.Watts 6W
Battery 3.2V / 5Ah
Flux 400lm
Beam Angle 90°
CRI Ra>80
IP Rating IP65
Body Color Grey

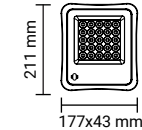

SKU: 5455
6000K

500
Lumens

Product code FL8-B5
EQ.Watts 8W
Battery 3.2V / 6Ah
Flux 500lm
Beam Angle 90°
CRI Ra>80
IP Rating IP65
Body Color Grey

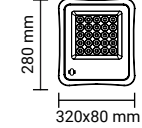

SKU: 5456
6000K

1200
Lumens

Product code FL15-B5
EQ.Watts 15W
Battery 3.2V / 10Ah
Flux 1200lm
Beam Angle 90°
CRI Ra>80
IP Rating IP65
Body Color Grey

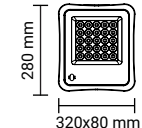

SKU: 5457
6000K

1800
Lumens

Product code FL20-B5
EQ.Watts 20W
Battery 3.2V / 20Ah
Flux 1800lm
Beam Angle 90°
CRI Ra>80
IP Rating IP65
Body Color Grey

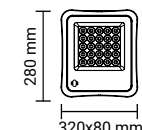

SKU: 5458
6000K

2400
Lumens

Product code FL30-B5
EQ.Watts 30W
Battery 3.2V / 25Ah
Flux 2400lm
Beam Angle 90°
CRI Ra>80
IP Rating IP65
Body Color Grey

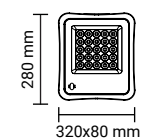

SKU: 5459
6000K



LED SMD FLOODLIGHT

White Body

10W
 900
 Lumens

Product code	FL10-B3	Beam Angle	90°
Watts	10W	CRI	Ra>80
Input Voltage	AC : 220-240V	IP Rating	IP65
Flux	900lm	Body Color	White

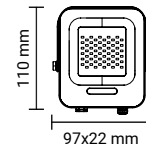

SKU: 5701 SKU: 5702 SKU: 5703

20W
 1800
 Lumens

Product code	FL20-B3	Beam Angle	90°
Watts	20W	CRI	Ra>80
Product code	AC : 220-240V	IP Rating	IP65
Flux	1800lm	Body Color	White

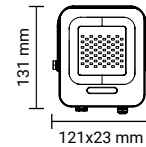

SKU: 5704 SKU: 5705 SKU: 5706

30W
 2700
 Lumens

Product code	FL30-B3	Beam Angle	90°
Watts	30W	CRI	Ra>80
Input Voltage	AC : 220-240V	IP Rating	IP65
Flux	2700lm	Body Color	White

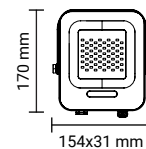

SKU: 5707 SKU: 5708 SKU: 5709

50W
 4500
 Lumens

Product code	FL50-B3	Beam Angle	90°
Watts	50W	CRI	Ra>80
Input Voltage	AC : 220-240V	IP Rating	IP65
Flux	4500lm	Body Color	White

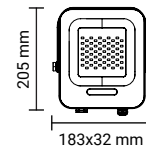

SKU: 5710 SKU: 5711 SKU: 5712

100W
 9000
 Lumens

Product code	FL100-B3	Beam Angle	90°
Watts	100W	CRI	Ra>80
Input Voltage	AC : 220-240V	IP Rating	IP65
Flux	9000lm	Body Color	White

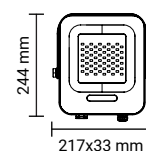

SKU: 5713 SKU: 5714 SKU: 5715



LED SMD FLOODLIGHT

Black Body

10W
 900
 Lumens

Product code	FL10-B3	Beam Angle	90°
Watts	10W	CRI	Ra>80
Input Voltage	AC : 220-240V	IP Rating	IP65
Flux	900lm	Body Color	Black

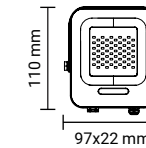

SKU: 5721 SKU: 5722 SKU: 5723

20W
 1800
 Lumens

Product code	FL20-B3	Beam Angle	90°
Watts	20W	CRI	Ra>80
Product code	AC : 220-240V	IP Rating	IP65
Flux	1800lm	Body Color	Black

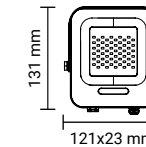

SKU: 5724 SKU: 5725 SKU: 5726

30W
 2700
 Lumens

Product code	FL30-B3	Beam Angle	90°
Watts	30W	CRI	Ra>80
Input Voltage	AC : 220-240V	IP Rating	IP65
Flux	2700lm	Body Color	Black

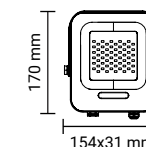

SKU: 5727 SKU: 5728 SKU: 5729

50W
 4500
 Lumens

Product code	FL50-B3	Beam Angle	90°
Watts	50W	CRI	Ra>80
Input Voltage	AC : 220-240V	IP Rating	IP65
Flux	4500lm	Body Color	Black

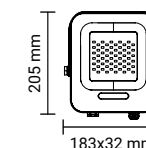

SKU: 5730 SKU: 5731 SKU: 5732

100W
 9000
 Lumens

Product code	FL100-B3	Beam Angle	90°
Watts	100W	CRI	Ra>80
Input Voltage	AC : 220-240V	IP Rating	IP65
Flux	9000lm	Body Color	Black

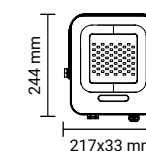

SKU: 5733 SKU: 5734 SKU: 5735

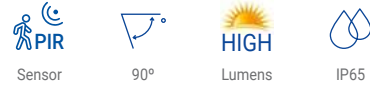

LED SMD FLOODLIGHT

White Body - PIR Sensor

10W 900 Lumens	Product code	FL10-B3	Beam Angle	90°	169 mm 97x54 mm	SKU: 5760	SKU: 5761	SKU: 5762
	Watts	10W	CRI	Ra>80				
	Input Voltage	AC : 220-240V	IP Rating	IP65				
	Flux	900lm	Body Color	White				

20W 1800 Lumens	Product code	FL20-B3	Beam Angle	90°	190 mm 121x54 mm	SKU: 5763	SKU: 5764	SKU: 5765
	Watts	20W	CRI	Ra>80				
	Input Voltage	AC : 220-240V	IP Rating	IP65				
	Flux	1800lm	Body Color	White				

30W 2700 Lumens	Product code	FL30-B3	Beam Angle	90°	228 mm 154x55 mm	SKU: 5766	SKU: 5767	SKU: 5768
	Watts	30W	CRI	Ra>80				
	Input Voltage	AC : 220-240V	IP Rating	IP65				
	Flux	2700lm	Body Color	White				

50W 4500 Lumens	Product code	FL50-B3	Beam Angle	90°	263 mm 183x57 mm	SKU: 5769	SKU: 5770
	Watts	50W	CRI	Ra>80			
	Input Voltage	AC : 220-240V	IP Rating	IP65			
	Flux	4500lm	Body Color	White			

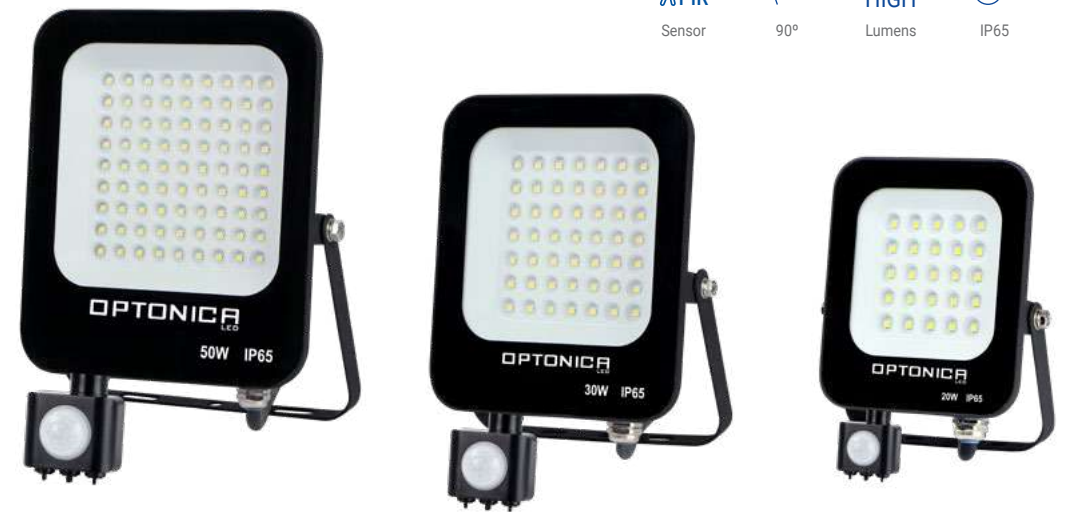
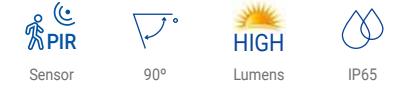

LED SMD FLOODLIGHT

Black Body - PIR Sensor

10W 900 Lumens	Product code	FL10-B3	Beam Angle	90°	169 mm 97x54 mm	SKU: 5771	SKU: 5772	SKU: 5773
	Watts	10W	CRI	Ra>80				
	Input Voltage	AC : 220-240V	IP Rating	IP65				
	Flux	900lm	Body Color	Black				

20W 1800 Lumens	Product code	FL20-B3	Beam Angle	90°	190 mm 121x54 mm	SKU: 5774	SKU: 5775	SKU: 5776
	Watts	20W	CRI	Ra>80				
	Input Voltage	AC : 220-240V	IP Rating	IP65				
	Flux	1800lm	Body Color	Black				

30W 2700 Lumens	Product code	FL30-B3	Beam Angle	90°	228 mm 154x55 mm	SKU: 5777	SKU: 5778	SKU: 5779
	Watts	30W	CRI	Ra>80				
	Input Voltage	AC : 220-240V	IP Rating	IP65				
	Flux	2700lm	Body Color	Black				

50W 4500 Lumens	Product code	FL50-B3	Beam Angle	90°	263 mm 183x57 mm	SKU: 5780	SKU: 5781
	Watts	50W	CRI	Ra>80			
	Input Voltage	AC : 220-240V	IP Rating	IP65			
	Flux	4500lm	Body Color	Black			



LED SMD FLOODLIGHT PF>0.9

High Power - Grey Body



100W 10000 Lumens	Product code Watts Input Voltage Flux	FL100-B4 100W AC : 220-240V 10000lm	Beam Angle CRI IP Rating Body Color	90° Ra>80 IP65 Grey
-----------------------------	--	--	--	------------------------------

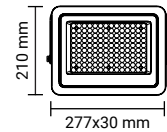

SKU: 5741 (6000K) SKU: 5742 (4500K)



LED SMD FLOODLIGHT PF>0.9

High Power - Grey Body



300W 36000 Lumens	Product code Watts Input Voltage Flux	FL150-A5 300W AC :220-240V 36000lm	Beam Angle CRI IP Rating Body Color	90° Ra>80 IP65 Grey
-----------------------------	--	---	--	------------------------------

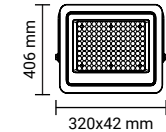

SKU: 5747 (6000K) SKU: 5748 (4500K)

150W 15000 Lumens	Product code Watts Input Voltage Flux	FL150-B4 150W AC : 220-240V 15000lm	Beam Angle CRI IP Rating Body Color	90° Ra>80 IP65 Grey
-----------------------------	--	--	--	------------------------------

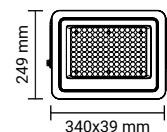

SKU: 5743 (6000K) SKU: 5744 (4500K)

400W 48000 Lumens	Product code Watts Input Voltage Flux	FL200-A5 400W AC :220-240V 48000lm	Beam Angle CRI IP Rating Body Color	90° Ra>80 IP65 Grey
-----------------------------	--	---	--	------------------------------

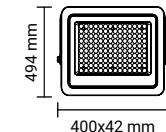

SKU: 5749 (6000K) SKU: 5750 (4500K)

200W 20000 Lumens	Product code Watts Input Voltage Flux	FL200-B4 200W AC : 220-240V 20000lm	Beam Angle CRI IP Rating Body Color	90° Ra>80 IP65 Grey
-----------------------------	--	--	--	------------------------------

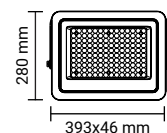

SKU: 5745 (6000K) SKU: 5746 (4500K)



5
 Years
 Warranty

 HIGH
 Lumens

IP65



Power Cable Length-0.70m

LED SMD FLOODLIGHT PF>0.9
Premium Line - White Body

 10W 850 Lumens	Product code	FL10-A5	Beam Angle	150°
	Watts	10W	CRI	Ra>80
	Input Voltage	AC : 175-265V	IP Rating	IP65
	Flux	850lm	Body Color	White

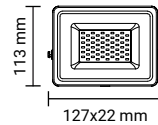
 SKU: 5865 SKU: 5866 SKU: 5867

 20W 1700 Lumens	Product code	FL20-A5	Beam Angle	150°
	Watts	20W	CRI	Ra>80
	Input Voltage	AC : 175-265V	IP Rating	IP65
	Flux	1700lm	Body Color	White

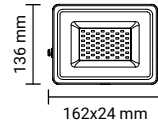
 SKU: 5868 SKU: 5869 SKU: 5870

 30W 2550 Lumens	Product code	FL30-A5	Beam Angle	150°
	Watts	30W	CRI	Ra>80
	Input Voltage	AC : 175-265V	IP Rating	IP65
	Flux	2550lm	Body Color	White

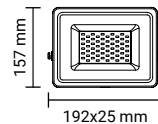
 SKU: 5871 SKU: 5872 SKU: 5873

 50W 4250 Lumens	Product code	FL50-A5	Beam Angle	150°
	Watts	50W	CRI	Ra>80
	Input Voltage	AC : 175-265V	IP Rating	IP65
	Flux	4250lm	Body Color	White

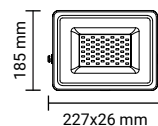
 SKU: 5874 SKU: 5875 SKU: 5876

 100W 8500 Lumens	Product code	FL100-A5	Beam Angle	150°
	Watts	100W	CRI	Ra>80
	Input Voltage	AC : 175-265V	IP Rating	IP65
	Flux	8500lm	Body Color	White

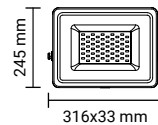
 SKU: 5877 SKU: 5878 SKU: 5879

 5
 Years
 Warranty

 HIGH
 Lumens

IP65



Power Cable Length-0.70m

LED SMD FLOODLIGHT PF>0.9
Premium Line - Black Body

 10W 850 Lumens	Product code	FL10-A5	Beam Angle	150°
	Watts	10W	CRI	Ra>80
	Input Voltage	AC : 175-265V	IP Rating	IP65
	Flux	850lm	Body Color	Black

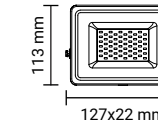
 SKU: 5880 SKU: 5881 SKU: 5882

 20W 1700 Lumens	Product code	FL20-A5	Beam Angle	150°
	Watts	20W	CRI	Ra>80
	Input Voltage	AC : 175-265V	IP Rating	IP65
	Flux	1700lm	Body Color	Black

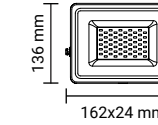
 SKU: 5883 SKU: 5884 SKU: 5885

 30W 2550 Lumens	Product code	FL30-A5	Beam Angle	150°
	Watts	30W	CRI	Ra>80
	Input Voltage	AC : 175-265V	IP Rating	IP65
	Flux	2550lm	Body Color	Black

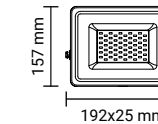
 SKU: 5886 SKU: 5887 SKU: 5888

 50W 4250 Lumens	Product code	FL50-A5	Beam Angle	150°
	Watts	50W	CRI	Ra>80
	Input Voltage	AC : 175-265V	IP Rating	IP65
	Flux	4250lm	Body Color	Black

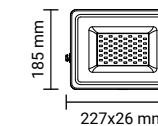
 SKU: 5889 SKU: 5890 SKU: 5891

 100W 8500 Lumens	Product code	FL100-A5	Beam Angle	150°
	Watts	100W	CRI	Ra>80
	Input Voltage	AC : 175-265V	IP Rating	IP65
	Flux	8500lm	Body Color	Black

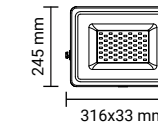
 SKU: 5892 SKU: 5893 SKU: 5894



LED SMD FLOODLIGHT PF>0.9
Premium Line - White Body

5 Years
Warranty

HIGH
Lumens

IP65



Power Cable Length-1.00m

LED SMD FLOODLIGHT PF>0.9
Premium Line - Black Body

5 Years
Warranty

HIGH
Lumens

IP65



Power Cable Length-1.00m

150W
18000
Lumens

Product code FL150-A5
Watts 150W
Input Voltage AC : 100-265V
Flux 18000lm

Beam Angle 150°
CRI Ra>80
IP Rating IP65
Body Color White

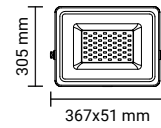

SKU: 5786 6000K
SKU: 5787 4500K

150W
18000
Lumens

Product code FL150-A5
Watts 150W
Input Voltage AC : 100-265V
Flux 18000lm

Beam Angle 150°
CRI Ra>80
IP Rating IP65
Body Color Black

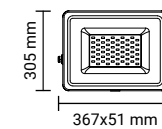

SKU: 5792 6000K
SKU: 5793 4500K

200W
24000
Lumens

Product code FL200-A5
Watts 200W
Input Voltage AC : 100-265V
Flux 24000lm

Beam Angle 150°
CRI Ra>80
IP Rating IP65
Body Color White

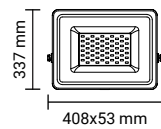

SKU: 5788 6000K
SKU: 5789 4500K

200W
24000
Lumens

Product code FL200-A5
Watts 200W
Input Voltage AC : 100-265V
Flux 24000lm

Beam Angle 150°
CRI Ra>80
IP Rating IP65
Body Color Black

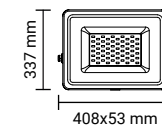

SKU: 5794 6000K
SKU: 5795 4500K

300W
36000
Lumens

Product code FL300-A5
Watts 300W
Input Voltage AC : 100-265V
Flux 36000lm

Beam Angle 150°
CRI Ra>80
IP Rating IP65
Body Color White

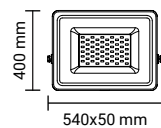

SKU: 5790 6000K
SKU: 5791 4500K

300W
36000
Lumens

Product code FL300-A5
Watts 300W
Input Voltage AC : 100-265V
Flux 36000lm

Beam Angle 150°
CRI Ra>80
IP Rating IP65
Body Color Black

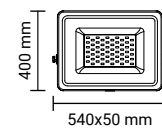

SKU: 5796 6000K
SKU: 5797 4500K

LED SMD FLOODLIGHT
CITY LINE - White Body
10W800
Lumens

Product code	FL10-B1	Beam Angle	120°
Watts	10W	CRI	Ra>80
Input Voltage	AC : 220-265V	IP Rating	IP65
Flux	800lm	Body Color	White

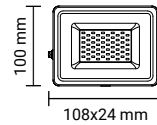
 SKU: 5900
 6000K
 SKU: 5901
4500K
SKU: 5902
2800K
20W1600
Lumens

Product code	FL20-B1	Beam Angle	120°
Watts	20W	CRI	Ra>80
Input Voltage	AC : 220-265V	IP Rating	IP65
Flux	1600lm	Body Color	White

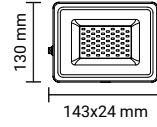
 SKU: 5903
 6000K
 SKU: 5904
4500K
SKU: 5905
2800K
30W2400
Lumens

Product code	FL30-B1	Beam Angle	120°
Watts	30W	CRI	Ra>80
Input Voltage	AC : 220-265V	IP Rating	IP65
Flux	2400lm	Body Color	White

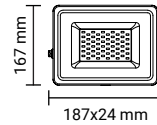
 SKU: 5906
 6000K
 SKU: 5907
4500K
SKU: 5908
2800K
50W4000
Lumens

Product code	FL50-B1	Beam Angle	120°
Watts	50W	CRI	Ra>80
Input Voltage	AC : 220-265V	IP Rating	IP65
Flux	4000lm	Body Color	White

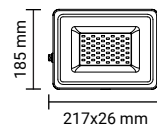

 SKU: 5909
 6000K
 SKU: 5910
4500K
SKU: 5911
2800K
100W8000
Lumens

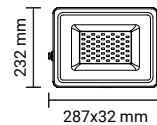
Product code	FL100-B1	Beam Angle	120°
Watts	100W	CRI	Ra>80
Input Voltage	AC : 220-265V	IP Rating	IP65
Flux	8000lm	Body Color	White

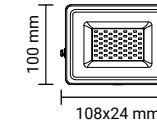

 SKU: 5912
 6000K
 SKU: 5913
4500K
SKU: 5914
2800K

LED SMD FLOODLIGHT
CITY LINE - Black Body
10W800
Lumens

Product code	FL10-B1	Beam Angle	120°
Watts	10W	CRI	Ra>80
Input Voltage	AC : 220-265V	IP Rating	IP65
Flux	800lm	Body Color	Black

 SKU: 5915
 6000K
 SKU: 5916
4500K
SKU: 5917
2800K
20W1600
Lumens

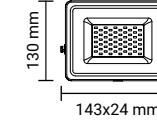
Product code	FL20-B1	Beam Angle	120°
Watts	20W	CRI	Ra>80
Input Voltage	AC : 220-265V	IP Rating	IP65
Flux	1600lm	Body Color	Black

 SKU: 5918
 6000K
 SKU: 5919
4500K
SKU: 5920
2800K
30W2400
Lumens

Product code	FL30-B1	Beam Angle	120°
Watts	30W	CRI	Ra>80
Input Voltage	AC : 220-265V	IP Rating	IP65
Flux	2400lm	Body Color	Black

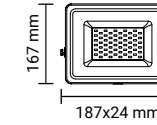
 SKU: 5921
 6000K
 SKU: 5922
4500K
SKU: 5923
2800K
50W4000
Lumens

Product code	FL50-B1	Beam Angle	120°
Watts	50W	CRI	Ra>80
Input Voltage	AC : 220-265V	IP Rating	IP65
Flux	4000lm	Body Color	Black

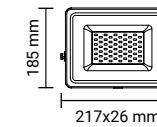
 SKU: 5924
 6000K
 SKU: 5925
4500K
SKU: 5926
2800K
100W8000
Lumens

Product code	FL100-B1	Beam Angle	120°
Watts	100W	CRI	Ra>80
Input Voltage	AC : 220-265V	IP Rating	IP65
Flux	8000lm	Body Color	Black

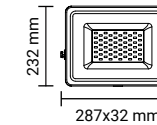
 SKU: 5927
 6000K
 SKU: 5928
4500K
SKU: 5929
2800K



**LED SMD FLOODLIGHT
CITY LINE- White Body
With PIR Sensor**

10W 800 Lumens	Product code Watts Input Voltage Flux	FL10-B2 10W AC : 220-265V 800lm	Beam Angle CRI IP Rating Body Color	120° Ra>80 IP65 White
--------------------------	--	--	--	--------------------------------

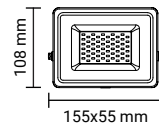

- SKU: 5930
6000K
- SKU: 5931
4500K
- SKU: 5932
2800K

20W 1600 Lumens	Product code Watts Input Voltage Flux	FL20-B2 20W AC : 220-265V 1600lm	Beam Angle CRI IP Rating Body Color	120° Ra>80 IP65 White
---------------------------	--	---	--	--------------------------------

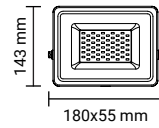

- SKU: 5933
6000K
- SKU: 5934
4500K
- SKU: 5935
2800K

30W 2400 Lumens	Product code Watts Input Voltage Flux	FL30-B2 30W AC : 220-265V 2400lm	Beam Angle CRI IP Rating Body Color	120° Ra>80 IP65 White
---------------------------	--	---	--	--------------------------------

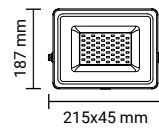

- SKU: 5936
6000K
- SKU: 5937
4500K
- SKU: 5938
2800K

50W 4000 Lumens	Product code Watts Input Voltage Flux	FL50-B2 50W AC : 220-265V 4000lm	Beam Angle CRI IP Rating Body Color	120° Ra>80 IP65 White
---------------------------	--	---	--	--------------------------------

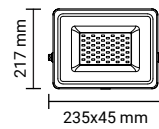

- SKU: 5939
6000K
- SKU: 5940
4500K



**LED SMD FLOODLIGHT
CITY LINE - Black Body
With PIR Sensor**

10W 800 Lumens	Product code Watts Input Voltage Flux	FL10-B2 10W AC : 220-265V 800lm	Beam Angle CRI IP Rating Body Color	120° Ra>80 IP65 Black
--------------------------	--	--	--	--------------------------------

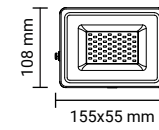

- SKU: 5941
6000K
- SKU: 5942
4500K
- SKU: 5943
2800K

20W 1600 Lumens	Product code Watts Input Voltage Flux	FL20-B2 20W AC : 220-265V 1600lm	Beam Angle CRI IP Rating Body Color	120° Ra>80 IP65 Black
---------------------------	--	---	--	--------------------------------

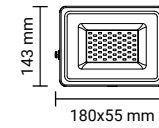

- SKU: 5944
6000K
- SKU: 5945
4500K
- SKU: 5946
2800K

30W 2400 Lumens	Product code Watts Input Voltage Flux	FL30-B2 30W AC : 220-265V 2400lm	Beam Angle CRI IP Rating Body Color	120° Ra>80 IP65 Black
---------------------------	--	---	--	--------------------------------

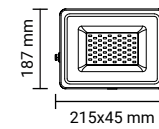

- SKU: 5947
6000K
- SKU: 5948
4500K
- SKU: 5949
2800K

50W 4000 Lumens	Product code Watts Input Voltage Flux	FL50-B2 50W AC : 220-265V 4000lm	Beam Angle CRI IP Rating Body Color	120° Ra>80 IP65 Black
---------------------------	--	---	--	--------------------------------

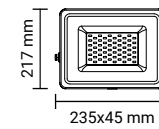

- SKU: 5950
6000K
- SKU: 5951
4500K



LED SMD FLOODLIGHT PF>0.9
CCT LIGHT - Black Body

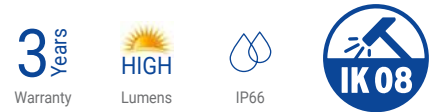

50W 5000 Lumens	Product code Watts Input Voltage Flux	FL50-A7 50W AC : 200-277V 5 000lm	Beam Angle CRI IP Rating Body Color	120° Ra>80 IP66 Black
---------------------------	--	--	--	--------------------------------

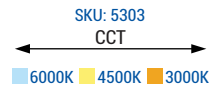
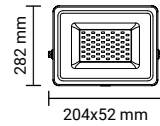

100W 10000 Lumens	Product code Watts Input Voltage Flux	FL100-A7 100W AC : 200-277V 10000lm	Beam Angle CRI IP Rating Body Color	120° Ra>80 IP66 Black
-----------------------------	--	--	--	--------------------------------

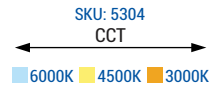
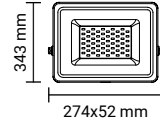

150W 15000 Lumens	Product code Watts Input Voltage Flux	FL150-A7 150W AC : 200-277V 15000lm	Beam Angle CRI IP Rating Body Color	120° Ra>80 IP66 Black
-----------------------------	--	--	--	--------------------------------

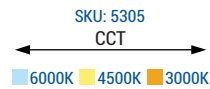
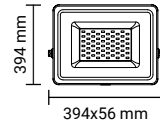

200W 20000 Lumens	Product code Watts Input Voltage Flux	FL200-A7 200W AC : 200-277V 20000lm	Beam Angle CRI IP Rating Body Color	120° Ra>80 IP66 Black
-----------------------------	--	--	--	--------------------------------

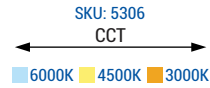
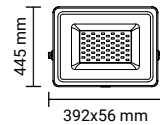

LED SMD FLOODLIGHT
CITY LINE - Black Body
With PIR Sensor

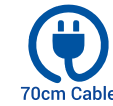

10W 800 Lumens	Product code Watts Input Voltage Flux	FL10-B2 10W AC : 220-265V 800lm	Beam Angle CRI IP Rating Body Color	120° Ra>80 IP65 Black
--------------------------	--	--	--	--------------------------------

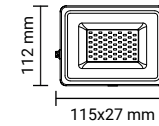

20W 1600 Lumens	Product code Watts Input Voltage Flux	FL20-B2 20W AC : 220-265V 1600lm	Beam Angle CRI IP Rating Body Color	120° Ra>80 IP65 Black
---------------------------	--	---	--	--------------------------------

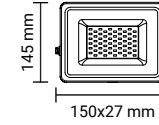

30W 2400 Lumens	Product code Watts Input Voltage Flux	FL30-B2 30W AC : 220-265V 2400lm	Beam Angle CRI IP Rating Body Color	120° Ra>80 IP65 Black
---------------------------	--	---	--	--------------------------------

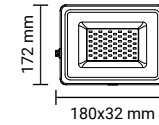

50W 4000 Lumens	Product code Watts Input Voltage Flux	FL50-B2 50W AC : 220-265V 4000lm	Beam Angle CRI IP Rating Body Color	120° Ra>80 IP65 Black
---------------------------	--	---	--	--------------------------------

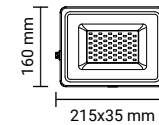



LED SMD FLOODLIGHT
On Stand - Foldable



20W



1600
Lumens

Product code	FL20-A8	Beam Angle	120°
Watts	20W	CRI	Ra>80
Input Voltage	AC : 200-240V	IP Rating	IP65
Flux	1600lm	Body Color	Yellow

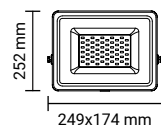

SKU: 5403
■ 6000K

30W



2400
Lumens

Product code	FL30-A8	Beam Angle	120°
Watts	30W	CRI	Ra>80
Input Voltage	AC : 200-240V	IP Rating	IP65
Flux	2400lm	Body Color	Yellow

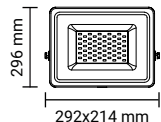

SKU: 5404
■ 6000K

50W



4000
Lumens

Product code	FL50-A8	Beam Angle	120°
Watts	50W	CRI	Ra>80
Input Voltage	AC : 200-240V	IP Rating	IP65
Flux	4000lm	Body Color	Yellow

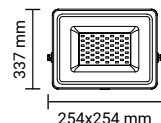

SKU: 5405
■ 6000K



PORTABLE LED SMD FLOODLIGHT
Rechargeable + Battery



Rechargeable



120°



IP44

Input Voltage	AC : 200-240V	Body Color	Yellow+Black
Beam Angle	120°	CRI	Ra>80
IP Rating	IP44	Dimension 10W	123x133x218mm
		Dimension 20W	156x163x250mm

10W



600
Lumens



3.7V 2200mAh

SKU: 5401
■ 6000K

20W



1200
Lumens



3.7V 4400mAh

SKU: 5402
■ 6000K



LED SMD PORTABLE FLOODLIGHT
Solar Panel Power: 6V/2.3W



Solar Power



1850
Lumens



120°



IP65

Flux	1850lm	Beam Angle	120°
Battery	3.7V 8Ah	CRI	Ra>80
Body Color	Yellow	Dimension	215x175x55mm

- SOS Emergency Light
- Power Bank Function
- USB Ports



3.7V 8Ah

SKU: 5464
CCT
■ 6000K ■ 4500K ■ 3000K



LED SMD FLOODLIGHT

Black Body -Green Light

90°



IP65

10W**800**

Lumens

Product code	FL10-B3	Beam Angle	90°
Watts	10W	CRI	Ra>70
Input Voltage	AC : 220-240V	IP Rating	IP65
Flux	800lm	Body Color	Black

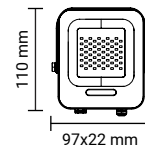
 SKU: 5751
 Green

LED RGB SMD FLOODLIGHT

Black Body + Remote Control

RGB



120°



IP65

10W**800**

Lumens

Product code	FL10-B4	Beam Angle	120°
Watts	10W	CRI	Ra>80
Input Voltage	AC : 200-240V	IP Rating	IP65
Flux	800lm	Body Color	Black

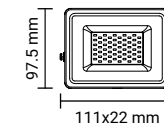
 SKU: 5754
 RGB
20W**1600**

Lumens

Product code	FL20-B3	Beam Angle	90°
Watts	20W	CRI	Ra>70
Product code	AC : 220-240V	IP Rating	IP65
Flux	1600lm	Body Color	Black

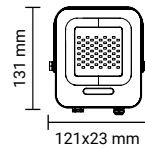
 SKU: 5752
 Green
30W**2400**

Lumens

Product code	FL30-B4	Beam Angle	120°
Watts	30W	CRI	Ra>80
Input Voltage	AC : 200-240V	IP Rating	IP65
Flux	2400lm	Body Color	Black

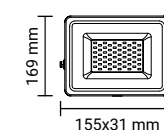
 SKU: 5755
 RGB
30W**2400**

Lumens

Product code	FL30-B3	Beam Angle	90°
Watts	30W	CRI	Ra>70
Input Voltage	AC : 220-240V	IP Rating	IP65
Flux	2400lm	Body Color	Black

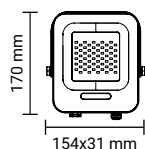
 SKU: 5753
 Green
50W**4000**

Lumens

Product code	FL50-B4	Beam Angle	120°
Watts	50W	CRI	Ra>80
Input Voltage	AC : 200-240V	IP Rating	IP65
Flux	4000lm	Body Color	Black

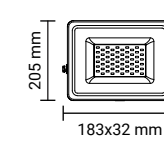
 SKU: 5756
 RGB

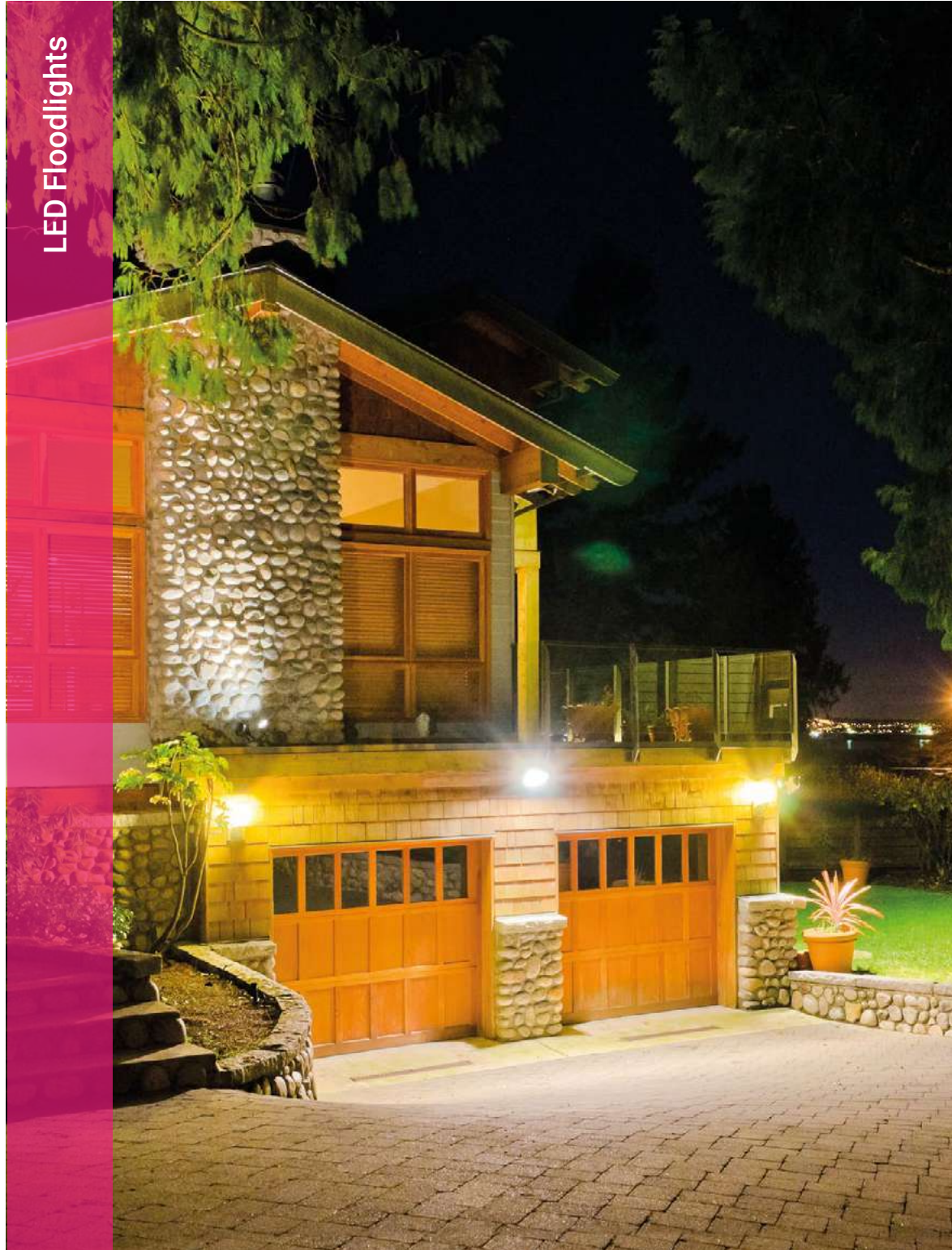

LED Floodlights



LED SMD5730 FLOODLIGHT PF>0.9
Dual Voltage With Terminal Block



100W



Product code	FL100-A9	Beam Angle	120°
Watts	100W	CRI	Ra>80
Input Voltage	AC : 85-265V	IP Rating	IP65
Flux	9000lm	Body Color	Black

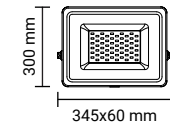

SKU: 5277
6000K

200W



Product code	FL200-A9	Beam Angle	120°
Watts	200W	CRI	Ra>80
Input Voltage	AC : 85-265V	IP Rating	IP65
Flux	18000lm	Body Color	Black

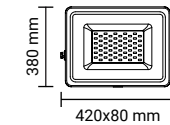

SKU: 5279
6000K





LED SMD FLOODLIGHT
High Power - Black Body



150W 13500 Lumens	Product code	FL150-B3	Beam Angle	90°
	Watts	150W	CRI	Ra>80
	Input Voltage	AC : 220-240V	IP Rating	IP65
	Flux	13500lm	Body Color	Black

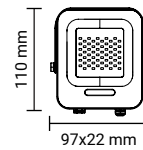

SKU: 5736 (6000K) SKU: 5737 (4500K)

200W 18000 Lumens	Product code	FL200-B3	Beam Angle	90°
	Watts	200W	CRI	Ra>80
	Input Voltage	AC : 220-240V	IP Rating	IP65
	Flux	18000lm	Body Color	Black

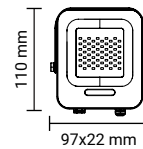

SKU: 5738 (6000K) SKU: 5739 (4500K)



LED SMD FLOODLIGHT
Classic Line 2 - High Power



150W 12750 Lumens	Product code	FL150-A3	Beam Angle	100°
	Watts	100W	CRI	Ra>80
	Input Voltage	AC : 170-265V	IP Rating	IP65
	Flux	12750lm	Body Color	Black

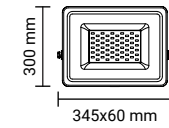

SKU: 5818 (6000K) SKU: 5819 (4500K)

200W 17000 Lumens	Product code	FL200-A3	Beam Angle	100°
	Watts	200W	CRI	Ra>80
	Input Voltage	AC : 170-265V	IP Rating	IP65
	Flux	17000lm	Body Color	Black

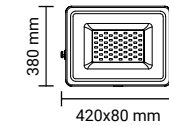

SKU: 5838 (6000K) SKU: 5839 (4500K)



Floodlight Spike
Body Color: Black
Material: Aluminium

SKU: 6682 160x35cm
SKU: 6683 265x55cm



Billboard Stand
Body Color: Black
Material: Iron

SKU: 6684 150x500cm
SKU: 6685 200x800cm



**TRIPOD FOR FLOODLIGHTS
With Cross Bar**

Product code OT1-B9
 Body Color Yellow , Black
 Material Iron
 Maximum size 157x64x64cm
 Height Adjustment: 64-157cm
 Sections: 3 Pcs

SKU: 6686 BLACK BODY ■
 SKU: 6687 YELLOW BODY ■

**Terminal Block
Waterproof Box**

Rated Voltage 250V
 Material Flame Retardant PP
 Wire Range 0.5-1.5mm²
 Wire Range-T 0.5-2.5mm²
 Rated Current 16A



**Terminal Blocks Professional
Metal-Waterproof Box**

Rated Voltage 450V
 Material Cast Aluminium
 Body Size 80x75x60mm
 Rated Current 24A



**Lever Connectors
Easy Clip**

Rated voltage 450V
 Rated current 32A
 Wire range 18-12AWG 0.08--2.5mm²
 Ambient temperature -40°C~+105°C
 Strip length 12-13mm

SKU: 6501
SKU: 6502
SKU: 6503
SKU: 6504
SKU: 6505

Rated voltage 450V
 Rated current 32A
 Housing material: thermoplastic, 94V-0
 Flame-retardant
 Temperature: 110 degrees Celsius
 Wire range: #24 to #12 AWG solid wires

SKU: 6506
SKU: 6507
SKU: 6508

**Terminal Block Splitter
Waterproof Box**

Rated Voltage 250V
 Material Polypropylene 94 V2
 Wire Range 0.5-2.5mm²
 Rated Current 16A



**Terminal Block Splitter
Waterproof Box**

Rated Voltage 450V
 Material Polypropylene 94 V2
 Wire Range 0.5-4mm²
 Rated Current 24A



**Terminal Blocks Professional
Polycarbonate-Waterproof Box**

Rated Voltage 250V
 Rated Current 16A
 Material Polycarbonate
 Body Size 120x35x50 mm



Rated Voltage 450V
 Rated Current 24A
 Material Polycarbonate
 Body Size 120x35x70 mm



**Terminal Block Splitter
Waterproof Box**

Rated Voltage 450V
 Material Polypropylene 94 V2
 Wire Range 0.5-4mm²
 Rated Current 24A



**Terminal Block Splitter
Waterproof Box**

Rated Voltage 450V
 Material Polypropylene 94 V2
 Wire Range 0.5-4mm²
 Rated Current 24A





LED STREET AND INDUSTRIAL LIGHTS



LED industrial lights are series of highly efficient, reliable and easy to install products for production sites, warehouses or specialised areas. With different types – low or high bays, bulbs or linear lighting fixtures. These products will meet all industry standards and cover any lighting needs.

Features:

- Up to 80% power saving
- Variety of shapes and types
- Long lifetime and reliability
- Different types of mounting options
- Comply with industrial standards

Application:

- Production sites and warehouses
- Industrial places and factories
- Special lighting requirements





LED SOLAR INDUSTRIAL LIGHTS

Remote Control



30W

4300
Lumens

Power Solar	5V/30W	CRI	Ra>80
Beam Angle	60°	IP Rating	IP66
Flux	4300lm	Body Color	Black

Battery
3.2V 30Ah

SKU: 9141
6000K

40W

5200
Lumens

Power Solar	5V/40W	CRI	Ra>80
Beam Angle	60°	IP Rating	IP66
Flux	5200lm	Body Color	Black

Battery
3.2V 35Ah

SKU: 9142
6000K

50W

6300
Lumens

Power Solar	5V/50W	CRI	Ra>80
Beam Angle	60°	IP Rating	IP66
Flux	6300lm	Body Color	Black

Battery
3.2V 45Ah

SKU: 9143
6000K



LED STREET LIGHT

Solar Power + Battery



500
Lumens

Product code	SL8-B6	Beam Angle	120°
Watts	8W	CRI	Ra>70
Battery	3.2V 5AH	IP Rating	IP65
Flux	500lm	Body Color	Black

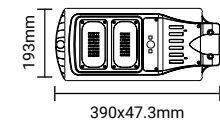

SKU: 9126
6000K

1200
Lumens

Product code	SL10-B6	Beam Angle	120°
Watts	10W	CRI	Ra>70
Battery	3.2V 10AH	IP Rating	IP65
Flux	1200lm	Body Color	Black

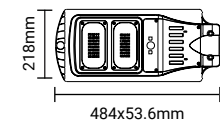

SKU: 9127
6000K

1800
Lumens

Product code	SL15-B6	Beam Angle	120°
Watts	15W	CRI	Ra>70
Battery	3.2V 15AH	IP Rating	IP65
Flux	1800lm	Body Color	Black

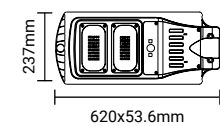

SKU: 9128
6000K

2400
Lumens

Product code	SL18-B6	Beam Angle	120°
Watts	18W	CRI	Ra>70
Battery	3.2V 20AH	IP Rating	IP65
Flux	2400lm	Body Color	Black

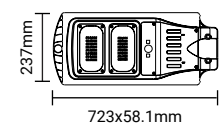

SKU: 9129
6000K



LED STREET LIGHT
8W Solar Power + Battery

Watts	8W	CRI	Ra>70
Battery	3.2V / 16.5Ah	IP Rating	IP65
Flux	950lm	Dimension	490x240x65mm
Beam Angle	120°	Body Color	Black

- * Intelligent Light Control
 - * Time Switch
- SKU: 9135
6000K



Wireless Remote Control

950 Lumens
 Battery
 >1500 Cycles
 Solar Power
 IP65



LED STREET LIGHT
35W Solar Power + Battery

Watts	35W	CRI	Ra>70
Battery	6.4V / 16.5Ah	IP Rating	IP65
Flux	2600lm	Dimension	490x240x65mm
Beam Angle	120°	Body Color	Black

- * Intelligent Light Control
 - * Time Switch
- SKU: 9137
6000K



Wireless Remote Control

2600 Lumens
 Battery
 >1500 Cycles
 Solar Power
 IP65



LED STREET LIGHT
12W Solar Power + Battery

Watts	12W	CRI	Ra>70
Battery	3.2V / 22Ah	IP Rating	IP65
Flux	1200lm	Dimension	650x250x65mm
Beam Angle	120°	Body Color	Black

- * Intelligent Light Control
 - * Time Switch
- SKU: 9136
6000K



Wireless Remote Control

1200 Lumens
 Battery
 >1500 Cycles
 Solar Power
 IP65



LED STREET LIGHT
40W Solar Power + Battery

Watts	40W	CRI	Ra>70
Battery	6.4V / 22h	IP Rating	IP65
Flux	3000lm	Dimension	490x240x65mm
Beam Angle	120°	Body Color	Black

- * Intelligent Light Control
 - * Time Switch
- SKU: 9138
6000K



Wireless Remote Control

3000 Lumens
 Battery
 >1500 Cycles
 Solar Power
 IP65

NEW PRODUCT



LED STREET LIGHT PF>0.9
High Lumens



50W 5000 Lumens	Product code Watts Input Voltage Flux	SL50-A9 50W AC : 220-240V 5000lm	Beam Angle CRI IP Rating Body Color	75x135° Ra>70 IP65 Gray	 400x153.6x76mm	SKU: 9221 6000K
---------------------------	--	---	--	----------------------------------	--	--------------------

100W 10000 Lumens	Product code Watts Input Voltage Flux	SL100-A9 100W AC : 220-240V 10000lm	Beam Angle CRI IP Rating Body Color	75x135° Ra>70 IP65 Gray	 500x196.3x76mm	SKU: 9222 6000K
-----------------------------	--	--	--	----------------------------------	--	--------------------

150W 15000 Lumens	Product code Watts Input Voltage Flux	SL150-A9 150W AC : 220-240V 15000lm	Beam Angle CRI IP Rating Body Color	75x135° Ra>70 IP65 Gray	 542x214x76mm	SKU: 9223 6000K
-----------------------------	--	--	--	----------------------------------	--	--------------------

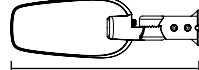
200W 20000 Lumens	Product code Watts Input Voltage Flux	SL200-A9 200W AC : 220-240V 20000lm	Beam Angle CRI IP Rating Body Color	75x135° Ra>70 IP65 Gray	 609x234.6x76mm	SKU: 9224 6000K
-----------------------------	--	--	--	----------------------------------	--	--------------------



LED STREET LIGHT PF>0.9
High Lumens



30W 3000 Lumens	Product code Watts Input Voltage Flux	SL30-A9 30W AC : 220-240V 3000lm	Beam Angle CRI IP Rating Body Color	75x135° Ra>70 IP65 Gray	 438x128mm	SKU: 9201 6000K	SKU: 9202 4500K	SKU: 9203 2700K
---------------------------	--	---	--	----------------------------------	--	--------------------	--------------------	--------------------

50W 5000 Lumens	Product code Watts Input Voltage Flux	SL50-A9 50W AC : 220-240V 5000lm	Beam Angle CRI IP Rating Body Color	75x135° Ra>70 IP65 Gray	 486x151mm	SKU: 9204 6000K	SKU: 9205 4500K	SKU: 9206 2700K
---------------------------	--	---	--	----------------------------------	--	--------------------	--------------------	--------------------

100W 10000 Lumens	Product code Watts Input Voltage Flux	SL100-A9 100W AC : 220-240V 10000lm	Beam Angle CRI IP Rating Body Color	75x135° Ra>70 IP65 Gray	 564x189mm	SKU: 9207 6000K	SKU: 9208 4500K	SKU: 9209 2700K
-----------------------------	--	--	--	----------------------------------	--	--------------------	--------------------	--------------------

150W 15000 Lumens	Product code Watts Input Voltage Flux	SL150-A9 150W AC : 220-240V 15000lm	Beam Angle CRI IP Rating Body Color	75x135° Ra>70 IP65 Gray	 638x210mm	SKU: 9210 6000K	SKU: 9211 4500K	SKU: 9212 2700K
-----------------------------	--	--	--	----------------------------------	--	--------------------	--------------------	--------------------

200W 20000 Lumens	Product code Watts Input Voltage Flux	SL200-A9 200W AC : 220-240V 20000lm	Beam Angle CRI IP Rating Body Color	75x135° Ra>70 IP65 Gray	 695x235mm	SKU: 9213 6000K	SKU: 9214 4500K	SKU: 9215 2700K
-----------------------------	--	--	--	----------------------------------	--	--------------------	--------------------	--------------------



LED STREET LIGHT **PF>0.95**
High Lumens-Moso Driver

MOSO
Driver

5
Years
Warranty

150
Lumens/W

HIGH
Lumens

120°

IP65

100W

15000
Lumens

Product code	SL100-A7	Beam Angle	120°
Watts	100W	CRI	Ra>70
Input Voltage	AC : 220-240V	IP Rating	IP65
Flux	15000lm	Protection	Class 1

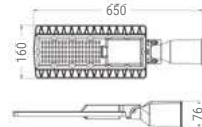

SKU: 9179
5700K

120W

18000
Lumens

Product code	SL120-A7	Beam Angle	120°
Watts	120W	CRI	Ra>70
Input Voltage	AC : 220-240V	IP Rating	IP65
Flux	18000lm	Protection	Class 1

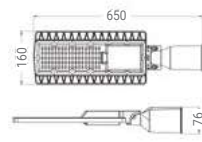

SKU: 9180
5700K

LED STREET LIGHT **PF>0.95**
High Lumens-Moso Driver

80W

11200
Lumens

Product code	SL80-A8	Beam Angle	120°
Watts	80W	CRI	Ra>70
Input Voltage	AC : 100-240V	IP Rating	IP66
Flux	11200lm	Protection	Class 1

SKU: 9196
5700K

100W

14000
Lumens

Product code	SL50-A8	Beam Angle	120°
Watts	100W	CRI	Ra>70
Input Voltage	AC : 100-240V	IP Rating	IP66
Flux	14000lm	Protection	Class 1

SKU: 9197
5700K

150W

21000
Lumens

Product code	SL150-A8	Beam Angle	120°
Watts	150W	CRI	Ra>70
Input Voltage	AC : 100-240V	IP Rating	IP66
Flux	21000lm	Protection	Class 1

SKU: 9198
5700K

180W

25200
Lumens

Product code	SL180-A8	Beam Angle	120°
Watts	180W	CRI	Ra>70
Input Voltage	AC : 100-240V	IP Rating	IP66
Flux	25200lm	Protection	Class 1

SKU: 9199
5700K

MOSO
Driver

5
Years
Warranty

140
Lumens/W

HIGH
Lumens

IP66



LED STREET LIGHT **PF>0.9**
2 pcs BOX



LED STREET LIGHT **PF>0.9**
2 pcs BOX



30W
4050
Lumens

Product code	SL30-A2	Beam Angle	120°
Watts	30W	CRI	Ra>70
Input Voltage	AC : 100-240V	IP Rating	IP65
Flux	4050lm	Protection	Class 1

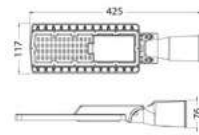

SKU: 9156
5700K

20W
2000
Lumens

Product code	SL20-A1	Beam Angle	120°
Watts	20W	CRI	Ra>70
Input Voltage	AC : 220-240V	IP Rating	IP65
Flux	2000lm	Protection	Class 2

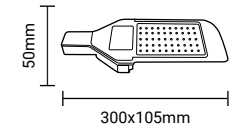

SKU: 9171
6000K

50W
7500
Lumens

Product code	SL50-A2	Beam Angle	120°
Watts	50W	CRI	Ra>70
Input Voltage	AC : 100-240V	IP Rating	IP65
Flux	7500lm	Protection	Class 1

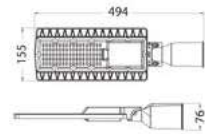

SKU: 9157
5700K

50W
5000
Lumens

Product code	SL50-A1	Beam Angle	120°
Watts	50W	CRI	Ra>70
Input Voltage	AC : 220-240V	IP Rating	IP65
Flux	5000lm	Protection	Class 2

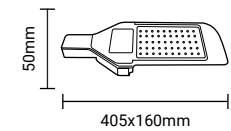

SKU: 9172
6000K

80W
8000
Lumens

Product code	SL80-A1	Beam Angle	120°
Watts	80W	CRI	Ra>70
Input Voltage	AC : 220-240V	IP Rating	IP65
Flux	8000lm	Protection	Class 2

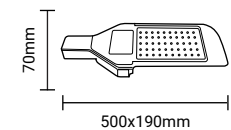

SKU: 9173
6000K

60W
8100
Lumens

Product code	SL60-A2	Beam Angle	120°
Watts	60W	CRI	Ra>70
Input Voltage	AC : 100-240V	IP Rating	IP65
Flux	8100lm	Protection	Class 1

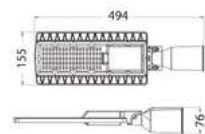

SKU: 9158
5700K

100W
10000
Lumens

Product code	SL100-A1	Beam Angle	120°
Watts	100W	CRI	Ra>70
Input Voltage	AC : 220-240V	IP Rating	IP65
Flux	10000lm	Protection	Class 2

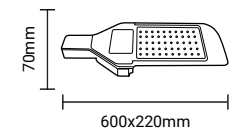

SKU: 9174
6000K



LED STREET LIGHT **PF>0.9**
Bridgelux 3030 Chips

5 Years Warranty
 HIGH Lumens
 120° Beam Angle
 IP65 Protection

150W
14250
 Lumens

Product code	SL150-A3	Beam Angle	120°
Watts	150W	CRI	Ra>70
Input Voltage	AC : 220-240V	IP Rating	IP65
Flux	14250lm	Protection	Class 1

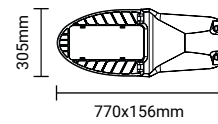

SKU: 9181
 5700K

200W
19000
 Lumens

Product code	SL200-A3	Beam Angle	120°
Watts	200W	CRI	Ra>70
Input Voltage	AC : 220-240V	IP Rating	IP65
Flux	19000lm	Protection	Class 1

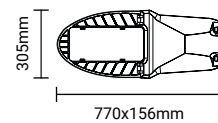

SKU: 9182
 5700K

Adapter Matt Grey Φ60mm to Φ40mm

SKU: 9118



Adapter Φ60mm to Φ60 mm Adjustable Angle 90°

SKU: 9119



LED INDUSTRIAL LIGHTS **PF>0.9**
Stadium Floodlight

5 Years Warranty
 HIGH Lumens
 90° Beam Angle
 IP65 Protection

100W
10000
 Lumens

Product code	SL100-A5	Beam Angle	90°
Watts	100W	CRI	Ra>70
Input Voltage	AC : 220-240V	IP Rating	IP65
Flux	10000lm	Protection	Class 1

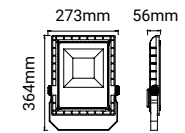

SKU: 9175
 5700K

150W
16500
 Lumens

Product code	SL150-A5	Beam Angle	90°
Watts	150W	CRI	Ra>70
Input Voltage	AC : 220-240V	IP Rating	IP65
Flux	16500lm	Protection	Class 1

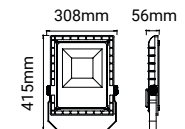

SKU: 9176
 5700K

240W
26400
 Lumens

Product code	SL240-A5	Beam Angle	90°
Watts	240W	CRI	Ra>70
Input Voltage	AC : 220-240V	IP Rating	IP65
Flux	26400lm	Protection	Class 1

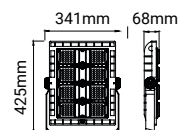

SKU: 9177
 5700K

480W
68000
 Lumens

Product code	SL480-A5	Beam Angle	90°
Watts	480W	CRI	Ra>70
Input Voltage	AC : 220-240V	IP Rating	IP65
Flux	68000lm	Protection	Class 1

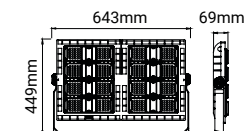

SKU: 9178
 5700K

NEW PRODUCT



LED INDUSTRIAL LIGHTS **PF>0.9**
SLIM LINE



50W

5000
Lumens

Watts	50W	Beam Angle	90°
Input Voltage	AC : 220-240V	IP Rating	IP65
Flux	5000lm	Body Color	Grey

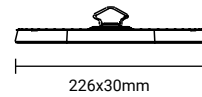

SKU: 8231 SKU: 8232
6000K 4500K

100W

10000
Lumens

Watts	100W	Beam Angle	90°
Input Voltage	AC : 220-240V	IP Rating	IP65
Flux	10000lm	Body Color	Grey

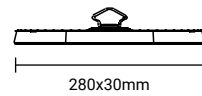

SKU: 8233 SKU: 8234
6000K 4500K

150W

15000
Lumens

Watts	150W	Beam Angle	90°
Input Voltage	AC : 220-240V	IP Rating	IP65
Flux	15000lm	Body Color	Grey

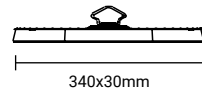

SKU: 8235 SKU: 8236
6000K 4500K

200W

20000
Lumens

Watts	200W	Beam Angle	90°
Input Voltage	AC : 220-240V	IP Rating	IP65
Flux	20000lm	Body Color	Grey

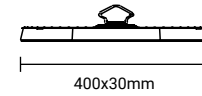

SKU: 8237 SKU: 8238
6000K 4500K

NEW PRODUCT



LED INDUSTRIAL LIGHTS **PF>0.9**
High Lumens



100W

10000
Lumens

Product code	HB100-B1	Beam Angle	90°
Watts	100W	CRI	Ra>80
Input Voltage	AC : 220-240V	IP Rating	IP65
Flux	10000lm	Body Color	Black

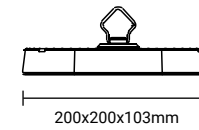

SKU: 8221 White Light 6000K
SKU: 8222 Neutral Light 4500K

150W

15000
Lumens

Product code	HB150-B1	Beam Angle	90°
Watts	150W	CRI	Ra>80
Input Voltage	AC : 220-240V	IP Rating	IP65
Flux	15000lm	Body Color	Black

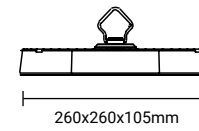

SKU: 8223 White Light 6000K
SKU: 8224 Neutral Light 4500K

200W

20000
Lumens

Product code	HB200-B1	Beam Angle	90°
Watts	200W	CRI	Ra>80
Input Voltage	AC : 220-240V	IP Rating	IP65
Flux	20000lm	Body Color	Black

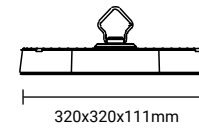

SKU: 8225 White Light 6000K
SKU: 8226 Neutral Light 4500K



LED INDUSTRIAL LIGHT HIGH LUMEN
HIGH BAY PF>0.9



100W
18000
Lumens

Product code	HB110-A1	Beam Angle	90°
Watts	100W	CRI	Ra>80
Input Voltage	AC : 220-240V	IP Rating	IP65
Flux	18000lm	Protection	Class 1

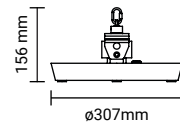

SKU: 8190
■ 5700K



LED INDUSTRIAL LIGHT
HIGH BAY UFO PF>0.9



100W
11000
Lumens

Product code	HB100-A5	Beam Angle	90°
Watts	100W	CRI	Ra>80
Input Voltage	AC : 220-240V	IP Rating	IP54
Flux	11000lm	Protection	Class 1

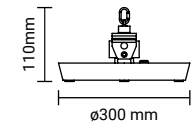

SKU: 8140
■ 5700K

150W
27000
Lumens

Product code	HB150-A3	Beam Angle	90°
Watts	150W	CRI	Ra>80
Input Voltage	AC : 220-240V	IP Rating	IP65
Flux	27000lm	Protection	Class 1

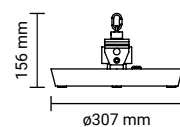

SKU: 8191
■ 5700K

150W
16500
Lumens

Product code	HB150-A5	Beam Angle	90°
Watts	150W	CRI	Ra>80
Input Voltage	AC : 220-240V	IP Rating	IP54
Flux	16500lm	Protection	Class 1

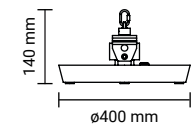

SKU: 8141
■ 5700K

200W
36000
Lumens

Product code	HB210-A1	Beam Angle	90°
Watts	200W	CRI	Ra>80
Input Voltage	AC : 220-240V	IP Rating	IP65
Flux	36000lm	Protection	Class 1

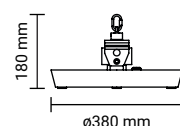

SKU: 8192
■ 5700K

200W
22000
Lumens

Product code	HB200-A5	Beam Angle	90°
Watts	200W	CRI	Ra>80
Input Voltage	AC : 220-240V	IP Rating	IP54
Flux	22000lm	Protection	Class 1

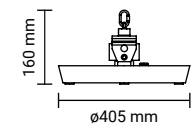

SKU: 8126
■ 5700K

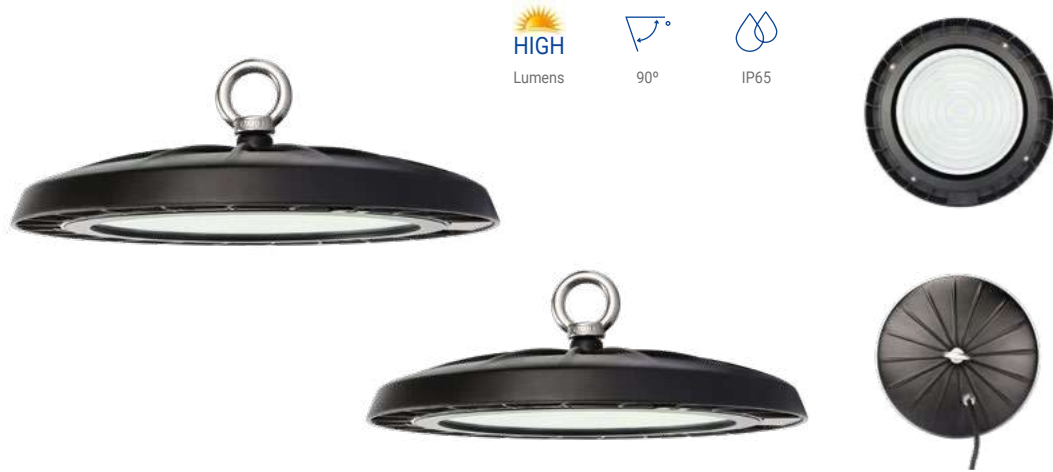

HIGH
Lumens

90°

IP65

LED INDUSTRIAL LIGHT
HIGH BAY - UFO - 90°

50W 5000 Lumens	Product code	HB50-A8	Beam Angle	90°
	Watts	50W	CRI	Ra>70
	Input Voltage	AC : 220-240V	IP Rating	IP65
	Flux	5000lm	Protection	Class 1

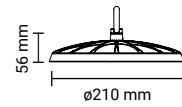

SKU: 8201 SKU: 8202
6000K 4500K



HIGH
Lumens

120°

IP65

LED INDUSTRIAL LIGHT
HIGH BAY - UFO - 120°

50W 5000 Lumens	Product code	HB50-A8	Beam Angle	120°
	Watts	50W	CRI	Ra>70
	Input Voltage	AC : 220-240V	IP Rating	IP65
	Flux	5000lm	Protection	Class 1

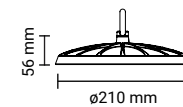

SKU: 8211 SKU: 8212
6000K 4500K

100W 10000 Lumens	Product code	HB100-A8	Beam Angle	90°
	Watts	100W	CRI	Ra>70
	Input Voltage	AC : 220-240V	IP Rating	IP65
	Flux	10000lm	Protection	Class 1

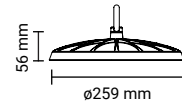

SKU: 8203 SKU: 8204
6000K 4500K

100W 10000 Lumens	Product code	HB100-A8	Beam Angle	120°
	Watts	100W	CRI	Ra>70
	Input Voltage	AC : 220-240V	IP Rating	IP65
	Flux	10000lm	Protection	Class 1

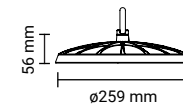

SKU: 8213 SKU: 8214
6000K 4500K

150W 15000 Lumens	Product code	HB150-A8	Beam Angle	90°
	Watts	150W	CRI	Ra>70
	Input Voltage	AC : 220-240V	IP Rating	IP65
	Flux	15000lm	Protection	Class 1

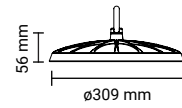

SKU: 8205 SKU: 8206
6000K 4500K

150W 15000 Lumens	Product code	HB150-A8	Beam Angle	120°
	Watts	150W	CRI	Ra>70
	Input Voltage	AC : 220-240V	IP Rating	IP65
	Flux	15000lm	Protection	Class 1

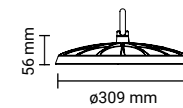

SKU: 8215 SKU: 8216
6000K 4500K

200W 20000 Lumens	Product code	HB200-A8	Beam Angle	90°
	Watts	200W	CRI	Ra>70
	Input Voltage	AC : 220-240V	IP Rating	IP65
	Flux	20000lm	Protection	Class 1

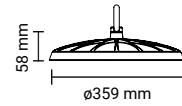

SKU: 8207 SKU: 8208
6000K 4500K

200W 20000 Lumens	Product code	HB200-A8	Beam Angle	120°
	Watts	200W	CRI	Ra>70
	Input Voltage	AC : 220-240V	IP Rating	IP65
	Flux	20000lm	Protection	Class 1

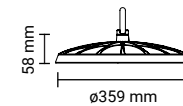

SKU: 8217 SKU: 8218
6000K 4500K

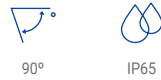
 LED INDUSTRIAL LIGHT
HIGH BAY - UFO 2 - 90°
**50W****4250**

Lumens

Product code	HB50-A6	Beam Angle	90°
Watts	50W	CRI	Ra>70
Input Voltage	AC : 220-240V	IP Rating	IP65
Flux	4250lm	Protection	Class 1

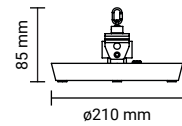
 SKU: 8166 SKU: 8167
 6000K 4500K

 LED INDUSTRIAL LIGHT
HIGH BAY - UFO 2 - 120°
**50W****4250**

Lumens

Product code	HB50-A6	Beam Angle	120°
Watts	50W	CRI	Ra>70
Input Voltage	AC : 220-240V	IP Rating	IP65
Flux	4250lm	Protection	Class 1

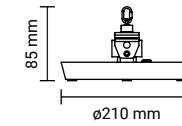
 SKU: 8175
 4500K
100W**8500**

Lumens

Product code	HB100-A6	Beam Angle	90°
Watts	100W	CRI	Ra>70
Input Voltage	AC : 220-240V	IP Rating	IP65
Flux	8500lm	Protection	Class 1

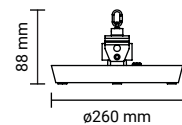
 SKU: 8168 SKU: 8169
 6000K 4500K
100W**8500**

Lumens

Product code	HB100-A6	Beam Angle	120°
Watts	100W	CRI	Ra>70
Input Voltage	AC : 220-240V	IP Rating	IP65
Flux	8500lm	Protection	Class 1

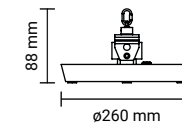
 SKU: 8177
 4500K
150W**12750**

Lumens

Product code	HB150-A6	Beam Angle	90°
Watts	150W	CRI	Ra>70
Input Voltage	AC : 220-240V	IP Rating	IP65
Flux	12750lm	Protection	Class 1

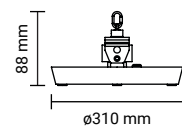
 SKU: 8170 SKU: 8171
 6000K 4500K
150W**12750**

Lumens

Product code	HB150-A6	Beam Angle	120°
Watts	150W	CRI	Ra>70
Input Voltage	AC : 220-240V	IP Rating	IP65
Flux	12750lm	Protection	Class 1

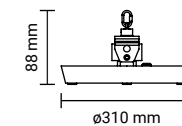
 SKU: 8178 SKU: 8179
 6000K 4500K
200W**17000**

Lumens

Product code	HB200-A6	Beam Angle	90°
Watts	200W	CRI	Ra>70
Input Voltage	AC : 220-240V	IP Rating	IP65
Flux	17000lm	Protection	Class 1

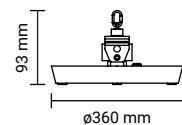
 SKU: 8172 SKU: 8173
 6000K 4500K
200W**17000**

Lumens

Product code	HB200-A6	Beam Angle	120°
Watts	200W	CRI	Ra>70
Input Voltage	AC : 220-240V	IP Rating	IP65
Flux	17000lm	Protection	Class 1

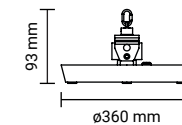
 SKU: 8181
 4500K



LED INDUSTRIAL LIGHT

Linear High Bay



50W



Product code	HB50-A2	Beam Angle	120°x60°
Watts	50W	CRI	Ra>70
Input Voltage	AC : 220-240V	IP Rating	IP44
Flux	5000lm	Body Color	Class 1

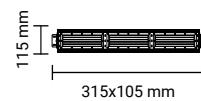

SKU: 8151
6000K 4500K

100W



Product code	HB100-A2	Beam Angle	120°x60°
Watts	50W	CRI	Ra>70
Input Voltage	AC : 220-240V	IP Rating	IP44
Flux	10000lm	Body Color	Black

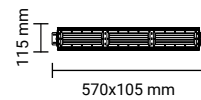

SKU: 8153
6000K 4500K

150W



Product code	HB150-A2	Beam Angle	120°x60°
Watts	50W	CRI	Ra>70
Input Voltage	AC : 220-240V	IP Rating	IP44
Flux	15000lm	Body Color	Black

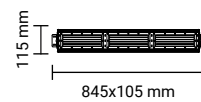

SKU: 8155
6000K 4500K

200W



Product code	HB200-A2	Beam Angle	120°x60°
Watts	50W	CRI	Ra>70
Input Voltage	AC : 220-240V	IP Rating	IP44
Flux	20000lm	Body Color	Black

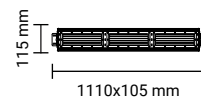

SKU: 8157
6000K 4500K



LED INDUSTRIAL Bulb **PF>0.9**
40W E27



Product code	HB40-A1	Socket	E27
Watts	40W	CRI	Ra>80
Input Voltage	AC : 180-264V	IP Rating	IP20
Flux	4100lm	Dimension	ø90x212 mm
Beam Angle	270°	Dimmable	NO

SKU: 225
6000K 4500K

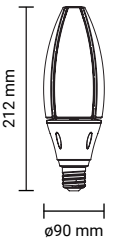

LED INDUSTRIAL Bulb **PF>0.9**
50W E40

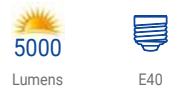

Product code	HB50-A3	Socket	E40
Watts	50W	CRI	Ra>70
Input Voltage	AC : 110-264V	IP Rating	IP20
Flux	5000lm	Dimension	ø75x235 mm
Beam Angle	270°	Dimmable	NO

SKU: 221
6000K

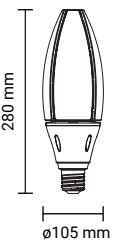

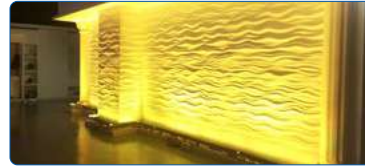

LED Wall Washers
30°

9W
 700
Lumens

Product code	WW9-A1	Beam Angle	30°
Watts	9W	CRI	Ra>70
Input Voltage	AC : 220-240V	IP Rating	IP65
Flux	700lm	Body Color	Black

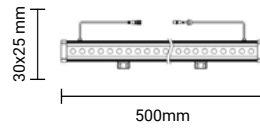

SKU: 7134 SKU: 7131
6000K 2700K

18W
 1400
Lumens

Product code	WW18-A1	Beam Angle	30°
Watts	18W	CRI	Ra>70
Input Voltage	AC : 220-240V	IP Rating	IP65
Flux	1400lm	Protection	Black

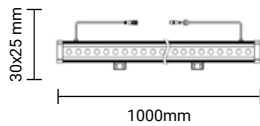

SKU: 7135 SKU: 7132
6000K 2700K

36W
 2800
Lumens

Product code	WW36-A1	Beam Angle	30°
Watts	36W	CRI	Ra>70
Input Voltage	AC : 220-240V	IP Rating	IP65
Flux	2800lm	Protection	Black

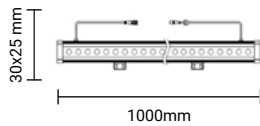

SKU: 7136 SKU: 7133
6000K 2700K





LED WALL AND STEP LIGHTS



You can even make your outdoor areas radiate in the worst of weather conditions: Our exterior use wall lights are robust, energy-efficient and powerful. You can choose between different designs and set stylish accents.

Features:

- Up to 80% power saving
- Home, garden or park use
- Different forms, shapes and colours
- Discrete, spot or main lighting
- Easy installation and long lifecycle
- With or without bulbs

Application:

- Wall or pylon mountable
- Lanes, alleys or pathways
- Gardens and parks

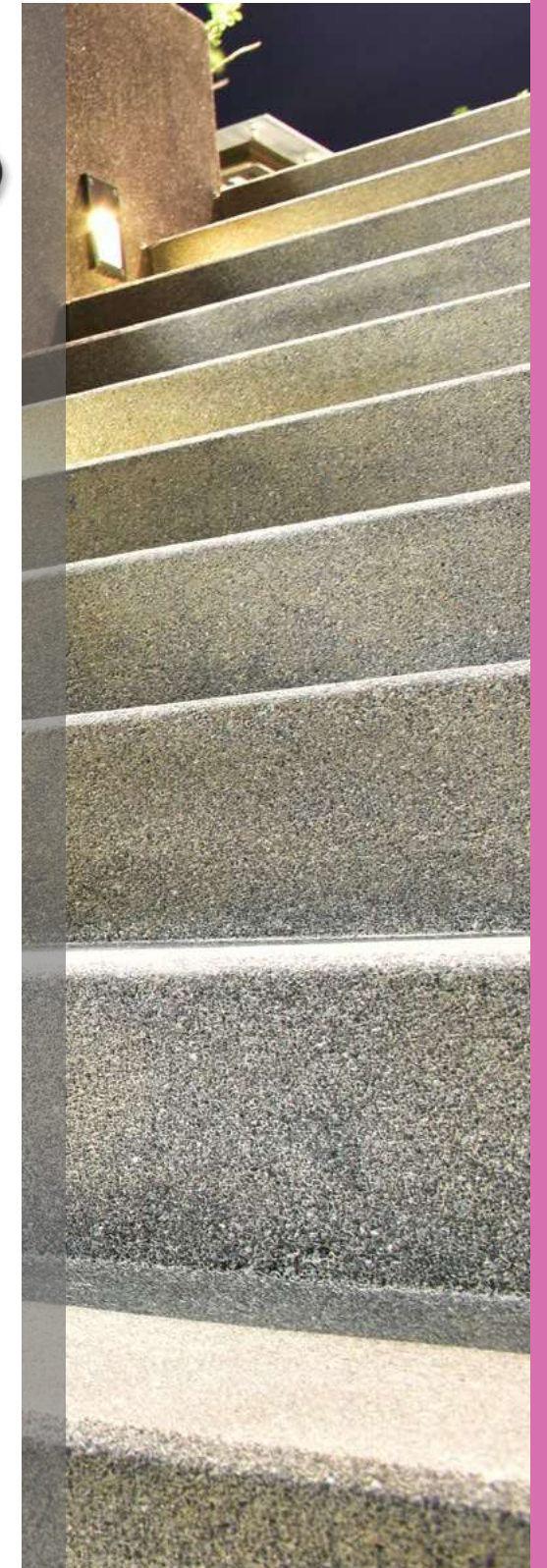

NEW PRODUCT

LED Wall Light - Black
2 Lens 4W

340
 Lumens

 48°

 IP65

Watts 4W
 Input Voltage AC : 200-240V
 Flux 340lm
 Beam Angle 48°
 Material Aluminium

CRI Ra>80
 IP Rating IP65
 Dimension 106x80x38 mm
 Body Color Black
 Dimmable NO

SKU: 7407
 3000K

NEW PRODUCT

LED Wall Light - Black
2 Lens 4W

340
 Lumens

 48°

 IP65

Watts 4W
 Input Voltage AC : 200-240V
 Flux 340lm
 Beam Angle 48°
 Material Aluminium

CRI Ra>80
 IP Rating IP65
 Dimension 106x80x38 mm
 Body Color White
 Dimmable NO

SKU: 7408
 3000K

NEW PRODUCT

LED Wall Light - Black
3 Lens 6W

510
 Lumens

 48°

 IP65

Watts 6W
 Input Voltage AC : 200-240V
 Flux 510lm
 Beam Angle 48°
 Material Aluminium

CRI Ra>80
 IP Rating IP65
 Dimension 158x80x40 mm
 Body Color Black
 Dimmable NO

SKU: 7409
 3000K

NEW PRODUCT

LED Wall Light - Black
3 Lens 6W

510
 Lumens

 48°

 IP65

Watts 6W
 Input Voltage AC : 200-240V
 Flux 510lm
 Beam Angle 48°
 Material Aluminium

CRI Ra>80
 IP Rating IP65
 Dimension 158x80x40 mm
 Body Color White
 Dimmable NO

SKU: 7410
 3000K

NEW PRODUCT

LED Wall Light - Black
2 Lens 8W

680
 Lumens

 48°

 IP65

Watts 8W
 Input Voltage AC : 200-240V
 Flux 680lm
 Beam Angle 48°
 Material Aluminium

CRI Ra>80
 IP Rating IP65
 Dimension 210x80x48 mm
 Body Color Black
 Dimmable NO

SKU: 7411
 3000K

NEW PRODUCT

LED Wall Light - Black
2 Lens 8W

680
 Lumens



 48°

 IP65

Watts 8W
 Input Voltage AC : 200-240V
 Flux 680lm
 Beam Angle 48°
 Material Aluminium

CRI Ra>80
 IP Rating IP65
 Dimension 210x80x48 mm
 Body Color White
 Dimmable NO

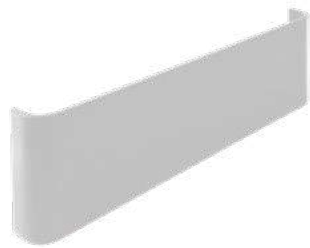
SKU: 7412
 3000K

LED Wall Light
12W

Watts	12W	CRI	Ra>80
Input Voltage	AC : 200-240V	IP Rating	IP20
Flux	600lm	Dimension	315x90x30mm
Beam Angle	160°	Body Color	WHITE
Material	Aluminium	Dimmable	NO

 SKU: 2095
 ■ 3000K

LED Wall Light
12W

Watts	12W	CRI	Ra>80
Input Voltage	AC : 200-240V	IP Rating	IP65
Flux	1200lm	Dimension	ø160x60mm
Beam Angle	90°	Body Color	White
Material	Plastic	Dimmable	NO

 SKU: 2089
 ■ 3000K

LED Wall Light
12W

Watts	12W	CRI	Ra>80
Input Voltage	AC : 200-240V	IP Rating	IP20
Flux	600lm	Dimension	315x90x30mm
Beam Angle	160°	Body Color	BLACK
Material	Aluminium	Dimmable	NO

 SKU: 2096
 ■ 3000K

LED Wall Light
12W

Watts	12W	CRI	Ra>80
Input Voltage	AC : 200-240V	IP Rating	IP65
Flux	1200lm	Dimension	ø160x60mm
Beam Angle	90°	Body Color	BLACK
Material	Plastic	Dimmable	NO

 SKU: 2090
 ■ 3000K

LED Solar Wall Light
1W

Watts	1W	CRI	Ra>80
Voltage	5.5V	IP Rating	IP44
Flux	60lm	Dimension	ø85x238mm
Beam Angle	80°	Body Color	White
Battery	3.7V/18Ah	Dimmable	NO

 SKU: 2085 SKU: 2086
 ■ 6000K ■ 4500K

LED Wall Light - Aluminium
12W

Watts	12W	CRI	Ra>80
Input Voltage	AC : 200-240V	IP Rating	IP65
Flux	670lm	Dimension	ø150x46mm
Beam Angle	90°	Body Color	WHITE
Material	Aluminium	Dimmable	NO

 SKU: 2091
 ■ 3000K

LED Solar Wall Light
1W

Watts	1W	CRI	Ra>80
Voltage	5.5V	IP Rating	IP44
Flux	60lm	Dimension	ø85x238mm
Beam Angle	80°	Body Color	Black
Battery	3.7V/18Ah	Dimmable	NO

 SKU: 2087 SKU: 2088
 ■ 6000K ■ 4500K

LED Wall Light - Aluminium
12W

Watts	12W	CRI	Ra>80
Input Voltage	AC : 200-240V	IP Rating	IP65
Flux	670lm	Dimension	ø150x46mm
Beam Angle	90°	Body Color	BLACK
Material	Aluminium	Dimmable	NO

 SKU: 2092
 ■ 3000K

LED Wall / Ceiling Light

15W

Watts	15W
Input Voltage	AC : 220-240V
Flux	80lm
Beam Angle	120°
Shape	Round

SKU: 7529 SKU: 7528
 ■ 4200K ■ 3000K

CRI	Ra>80
IP Rating	IP65
Dimension	ø169x100 mm
Body Color	BLACK
Dimmable	NO

750
Lumens

120°

IP65

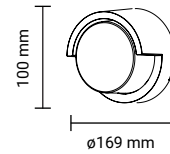

750
Lumens

120°

IP65

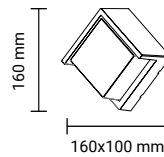

LED Wall / Ceiling Light

15W

Watts	15W
Input Voltage	AC : 220-240V
Flux	80lm
Beam Angle	120°
Shape	Square

SKU: 7531 SKU: 7530
 ■ 4200K ■ 3000K

CRI	Ra>80
IP Rating	IP65
Dimension	160x160x100 mm
Body Color	BLACK
Dimmable	NO

LED Wall / Ceiling Light

15W

Watts	15W
Input Voltage	AC : 220-240V
Flux	1000lm
Beam Angle	145°
Shape	Round

SKU: 7533 SKU: 7532
 ■ 4200K ■ 3000K

CRI	Ra>80
IP Rating	IP65
Dimension	ø169x100 mm
Body Color	BLACK
Dimmable	NO

1000
Lumens

145°

IP65

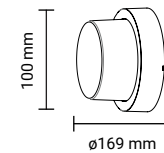

LED Wall / Ceiling Light

15W

Watts	15W
Input Voltage	AC : 220-240V
Flux	1000lm
Beam Angle	145°
Shape	Square

SKU: 7535 SKU: 7534
 ■ 4200K ■ 3000K

CRI	Ra>80
IP Rating	IP65
Dimension	160x160x100 mm
Body Color	BLACK
Dimmable	NO

1000
Lumens

145°

IP65

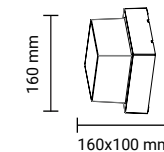

LED Solar Wall Light

16W

Watts	16W
Input Voltage	220-240V
Flux	1120lm
Beam Angle	90°
Material	Aluminium
CRI	Ra>80
IP Rating	IP20
Dimension	800x60x100mm
Dimmable	NO

SKU: 2093 SKU: 2094
 ■ 4200K ■ 3000K

1120
Lumens

90°

IP20



LED Wall Light

9W

Product code	WL9-A1
Watts	12W
Input Voltage	AC : 200-240V
Flux	780lm
Beam Angle	6°
Shape	Single Head
CRI	Ra>80
IP Rating	IP54
Dimension	230x110x76
Body Color	BLACK
Dimmable	NO

SKU: 7404 SKU: 7403
 ■ 4000K ■ 3000K

780
Lumens

6°

IP54



LED BULKHEAD WALL LIGHT

12W

Product code	WL12-A3
Watts	12W
Input Voltage	AC : 220-240V
Flux	780lm
Beam Angle	120°
Shape	Rectangle
CRI	Ra>80
IP Rating	IP65
Dimension	230x110x76mm
Body Color	GREY
Dimmable	NO

SKU: 7527 SKU: 7526
 ■ 4200K ■ 3000K

780
Lumens

120°

IP65



 LED Wall Light
6W

Watts	6W	CRI	Ra>80
Input Voltage	AC : 220-240V	IP Rating	IP54
Flux	660lm	Dimension	110x54x97
Beam Angle	120°	Body Color	WHITE
Shape	Single Head	Dimmable	NO

Rotatable 355°

 SKU: 7478 SKU: 7475
 4000K 3000K

 LED Wall Light
2x6W

Watts	12W	CRI	Ra>80
Input Voltage	AC : 220-240V	IP Rating	IP54
Flux	1320lm	Dimension	221x54x97mm
Beam Angle	120°	Body Color	WHITE
Shape	Double Head	Dimmable	NO

Rotatable 355°

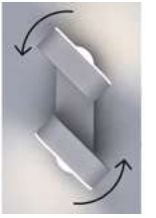
 SKU: 7484 SKU: 7481
 4000K 3000K

 LED Wall Light
6W

Watts	6W	CRI	Ra>80
Input Voltage	AC : 220-240V	IP Rating	IP54
Flux	660lm	Dimension	110x54x97
Beam Angle	120°	Body Color	BLACK
Shape	Single Head	Dimmable	NO

Rotatable 355°

 SKU: 7479 SKU: 7476
 4000K 3000K

 LED Wall Light
2x6W

Watts	12W	CRI	Ra>80
Input Voltage	AC : 220-240V	IP Rating	IP54
Flux	1320lm	Dimension	221x54x97mm
Beam Angle	120°	Body Color	BLACK
Shape	Double Head	Dimmable	NO

Rotatable 355°

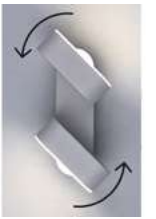
 SKU: 7485 SKU: 7482
 4000K 3000K

 LED Wall Light
6W

Watts	6W	CRI	Ra>80
Input Voltage	AC : 220-240V	IP Rating	IP54
Flux	660lm	Dimension	110x54x97
Beam Angle	120°	Body Color	GREY
Shape	Single Head	Dimmable	NO

Rotatable 355°

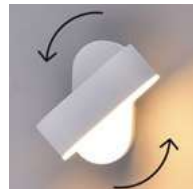
 SKU: 7480 SKU: 7477
 4000K 3000K

 LED Wall Light
2x6W

Watts	12W	CRI	Ra>80
Input Voltage	AC : 220-240V	IP Rating	IP54
Flux	1320lm	Dimension	221x54x97mm
Beam Angle	120°	Body Color	GREY
Shape	Double Head	Dimmable	NO

Rotatable 355°

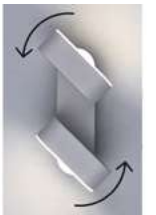

 SKU: 7486 SKU: 7483
 4000K 3000K



LED Wall Light
6W

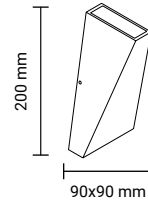

Watts	6W	CRI	Ra>80
Input Voltage	AC : 220-240V	IP Rating	IP54
Flux	660lm	Dimension	90x90x200mm
Beam Angle	Up 15°-Down 90°	Body Color	WHITE
Shape	Triangle	Dimmable	NO



SKU: 7472 SKU: 7469
■ 4200K ■ 3000K



LED Wall Light
6W



Watts	6W	CRI	Ra>80
Input Voltage	AC : 220-240V	IP Rating	IP54
Flux	660lm	Dimension	140x115x100mm
Beam Angle	0°- 90°	Body Color	WHITE
Shape	Round	Dimmable	NO

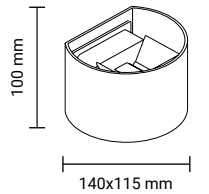

SKU: 7466 SKU: 7463
■ 4000K ■ 3000K



LED Wall Light
6W



Watts	6W	CRI	Ra>80
Input Voltage	AC : 220-240V	IP Rating	IP54
Flux	660lm	Dimension	90x90x200mm
Beam Angle	Up 15°-Down 90°	Body Color	BLACK
Shape	Triangle	Dimmable	NO

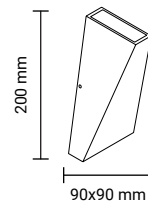

SKU: 7473 SKU: 7470
■ 4200K ■ 3000K



LED Wall Light
6W



Watts	6W	CRI	Ra>80
Input Voltage	AC : 220-240V	IP Rating	IP54
Flux	660lm	Dimension	140x115x100mm
Beam Angle	0°- 90°	Body Color	BLACK
Shape	Round	Dimmable	NO

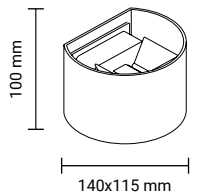

SKU: 7467 SKU: 7464
■ 4000K ■ 3000K



LED Wall Light
6W



Watts	6W	CRI	Ra>80
Input Voltage	AC : 220-240V	IP Rating	IP54
Flux	660lm	Dimension	90x90x200mm
Beam Angle	Up 15°-Down 90°	Body Color	GREY
Shape	Triangle	Dimmable	NO

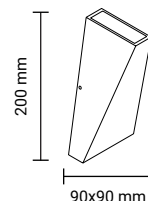

SKU: 7474 SKU: 7471
■ 4200K ■ 3000K



LED Wall Light
6W



Watts	6W	CRI	Ra>80
Input Voltage	AC : 220-240V	IP Rating	IP54
Flux	660lm	Dimension	140x115x100mm
Beam Angle	0°- 90°	Body Color	GREY
Shape	Roun	Dimmable	NO

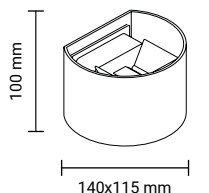

SKU: 7468 SKU: 7465
■ 4000K ■ 3000K



LED Wall Light
6W

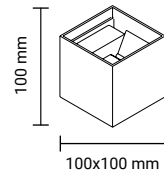

WHITE
SKU: 7454 SKU: 7451
4000K 3000K

BLACK
SKU: 7455 SKU: 7452
4000K 3000K

GREY
SKU: 7456 SKU: 7453
4000K 3000K

Watts	6W	CRI	Ra>80
Input Voltage	AC : 220-240V	IP Rating	IP54
Flux	660lm	Dimension	100x100 mm
Beam Angle	0°-90°	Body Colors	White ; Black ; Grey
Shape	Square	Dimmable	NO



LED Wall Light
12W

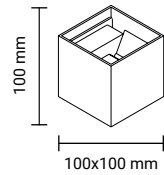

WHITE
SKU: 7460 SKU: 7457
4000K 3000K

BLACK
SKU: 7461 SKU: 7458
4000K 3000K

GREY
SKU: 7462 SKU: 7459
4000K 3000K

Watts	12W	CRI	Ra>80
Input Voltage	AC : 220-240V	IP Rating	IP54
Flux	1320lm	Dimension	100x100 mm
Beam Angle	0°-90°	Body Colors	White ; Black ; Grey
Shape	Square	Dimmable	NO

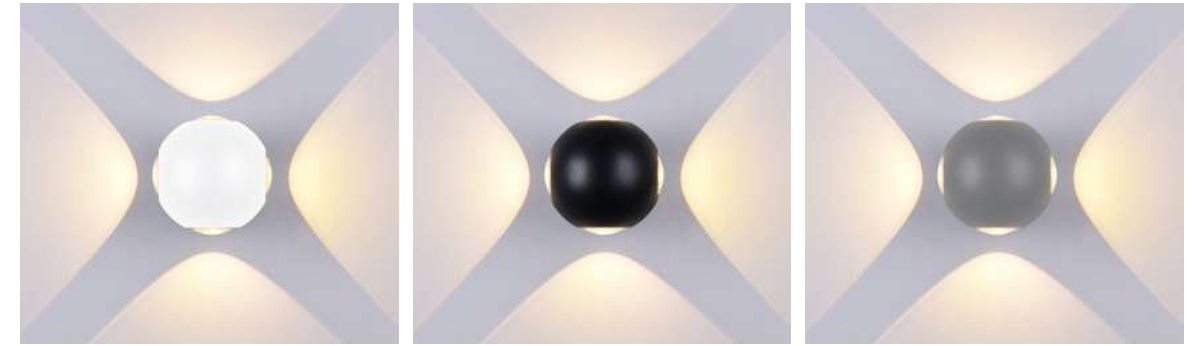

LED Wall Light
4W-4 Beam

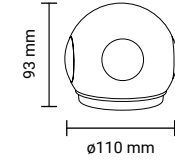
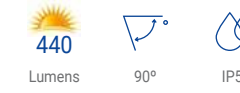

WHITE
SKU: 7490 SKU: 7487
4000K 3000K

BLACK
SKU: 7491 SKU: 7488
4000K 3000K

GREY
SKU: 7492 SKU: 7489
4000K 3000K

Watts	4W	CRI	Ra>80
Input Voltage	AC : 220-240V	IP Rating	IP54
Flux	440lm	Dimension	ø110x93 mm
Beam Angle	90°	Body Colors	White ; Black ; Grey
Shape	Round	Dimmable	NO



LED Wall Light
6W-2 Beam

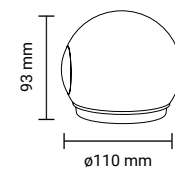
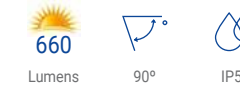

WHITE
SKU: 7496 SKU: 7493
4000K 3000K

BLACK
SKU: 7497 SKU: 7494
4000K 3000K

GREY
SKU: 7498 SKU: 7495
4000K 3000K

Watts	6W	CRI	Ra>80
Input Voltage	AC : 220-240V	IP Rating	IP54
Flux	660lm	Dimension	ø110x93 mm
Beam Angle	90°	Body Colors	White ; Black ; Grey
Shape	Round	Dimmable	NO

LED STEP LIGHT
2W Round

Watts 2W
 Input Voltage AC : 220-240V
 Flux 80lm
 Beam Angle 55°
 Shape Round

CRI Ra>80
 IP Rating IP65
 Dimension ϕ 150x27 mm
 Body Color BLACK
 Dimmable NO

SKU: 7504 SKU: 7503
 4200K 3000K

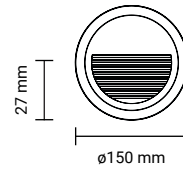
LED STEP LIGHT
2W Square

Watts 2W
 Input Voltage AC : 220-240V
 Flux 80lm
 Beam Angle 55°
 Shape Square

CRI Ra>80
 IP Rating IP65
 Dimension 124x124x27mm
 Body Color BLACK
 Dimmable NO

SKU: 7510 SKU: 7509
 4200K 3000K

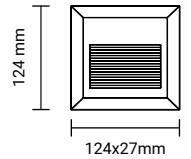
LED STEP LIGHT
2W Round

Watts 2W
 Input Voltage AC : 220-240V
 Flux 80lm
 Beam Angle 55°
 Shape Round

CRI Ra>80
 IP Rating IP65
 Dimension ϕ 150x27 mm
 Body Color WHITE
 Dimmable NO

SKU: 7506 SKU: 7505
 4200K 3000K

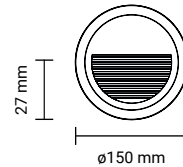
LED STEP LIGHT
2W Square

Watts 2W
 Input Voltage AC : 220-240V
 Flux 80lm
 Beam Angle 55°
 Shape Square

CRI Ra>80
 IP Rating IP65
 Dimension 124x124x27mm
 Body Color WHITE
 Dimmable NO

SKU: 7512 SKU: 7511
 4200K 3000K

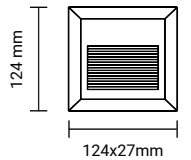
LED STEP LIGHT
2W Round

Watts 2W
 Input Voltage AC : 220-240V
 Flux 80lm
 Beam Angle 55°
 Shape Round

CRI Ra>80
 IP Rating IP65
 Dimension ϕ 150x27 mm
 Body Color GREY
 Dimmable NO

SKU: 7508 SKU: 7507
 4200K 3000K

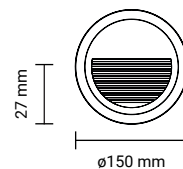
LED STEP LIGHT
2W Square

Watts 2W
 Input Voltage AC : 220-240V
 Flux 80lm
 Beam Angle 55°
 Shape Square

CRI Ra>80
 IP Rating IP65
 Dimension 124x124x27mm
 Body Color GREY
 Dimmable NO

SKU: 7514 SKU: 7513
 4200K 3000K

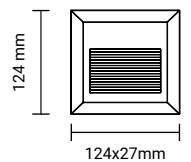

LED STEP LIGHT

3W Rectangular

Watts	3W	CRI	Ra>80
Input Voltage	AC : 220-240V	IP Rating	IP65
Flux	150lm	Dimension	280x280x28 mm
Beam Angle	65°	Body Color	BLACK
Shape	Rectangular	Dimmable	NO

SKU: 7516 SKU: 7515
 ■ 4200K ■ 3000K

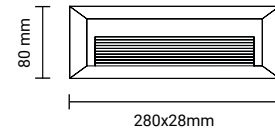

LED STEP LIGHT

3W Round

Watts	3W	CRI	Ra>80
Input Voltage	AC : 220-240V	IP Rating	IP20
Flux	90lm	Dimension	ø80x51 mm
Beam Angle	34°	Body Color	WHITE
Shape	Round	Dimmable	NO

SKU: 7523 SKU: 7522
 ■ 4200K ■ 3000K

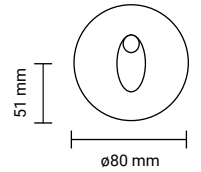

LED STEP LIGHT

3W Rectangular

Watts	3W	CRI	Ra>80
Input Voltage	AC : 220-240V	IP Rating	IP65
Flux	150lm	Dimension	280x280x28 mm
Beam Angle	65°	Body Color	WHITE
Shape	Rectangular	Dimmable	NO

SKU: 7518 SKU: 7517
 ■ 4200K ■ 3000K

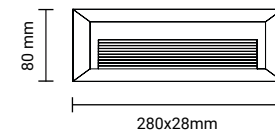

LED STEP LIGHT

3W Square

Watts	3W	CRI	Ra>80
Input Voltage	AC : 220-240V	IP Rating	IP20
Flux	90lm	Dimension	80x80x51 mm
Beam Angle	34°	Body Color	WHITE
Shape	Square	Dimmable	NO

SKU: 7525 SKU: 7524
 ■ 4200K ■ 3000K

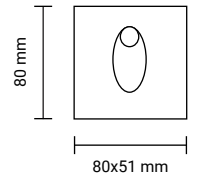

LED STEP LIGHT

3W Rectangular

Watts	3W	CRI	Ra>80
Input Voltage	AC : 220-240V	IP Rating	IP65
Flux	150lm	Dimension	280x280x28 mm
Beam Angle	65°	Body Color	GREY
Shape	Rectangular	Dimmable	NO

SKU: 7520 SKU: 7519
 ■ 4200K ■ 3000K

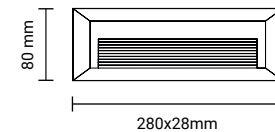

LED STEP LIGHT

3W Square

Watts	3W	CRI	Ra>80
Input Voltage	AC : 220-240V	IP Rating	IP65
Flux	195lm	Dimension	84x27 mm
Beam Angle	58°	Body Color	WHITE
Shape	Square	Dimmable	NO

SKU: 7521
 ■ 4200K

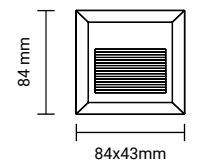

NEW PRODUCT

LED CABINET LIGHT
Slim Fit 1.5W

Voltage	DC:5V	CRI	Ra>80
Flux	100lm	IP Rating	IP20
Beam Angle	120°	Body Color	Black
Battery	3.7V 0.9Ah	Dimension	240x40x10mm

 SKU: 240
 ■ 3000K

Battery Sensor



100 Lumens IP20

NEW PRODUCT

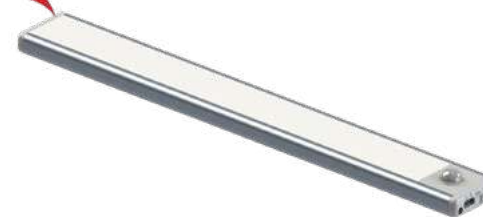
LED CABINET LIGHT
Slim Fit 1.5W

Voltage	DC:5V	CRI	Ra>80
Flux	140lm	IP Rating	IP20
Beam Angle	120°	Body Color	Silver
Battery	3.7V 1.1Ah	Dimension	240x40x10mm

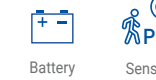
 SKU: 230 ■ 4500K
 SKU: 231 ■ 3000K

Battery Sensor



140 Lumens IP20

NEW PRODUCT

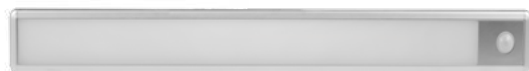
LED CABINET LIGHT
Slim Fit 1.5W

Voltage	DC:5V	CRI	Ra>80
Flux	100lm	IP Rating	IP20
Beam Angle	120°	Body Color	Silver
Battery	3.7V 0.9Ah	Dimension	240x40x10mm

 SKU: 241
 ■ 3000K

Battery Sensor



100 Lumens IP20

NEW PRODUCT

LED CABINET LIGHT
Slim Fit 2.5W

Voltage	DC:5V	CRI	Ra>80
Flux	200lm	IP Rating	IP20
Beam Angle	180°	Body Color	Silver
Battery	3.7V 2Ah	Dimension	240x40x10mm

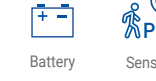
 SKU: 232
 CCT
 ← 6000K 4500K 3000K →

Battery Sensor



200 Lumens IP20

NEW PRODUCT

LED CABINET LIGHT
Slim Fit 3.5W

Voltage	DC:5V	CRI	Ra>80
Flux	230lm	IP Rating	IP20
Beam Angle	120°	Body Color	Black
Battery	3.7V 2.2Ah	Dimension	600x40x10mm

 SKU: 242
 ■ 3000K

Battery Sensor



230 Lumens IP20

NEW PRODUCT

LED CABINET LIGHT
Magnetic Control 0.5W

Voltage	DC:1.5V	CRI	Ra>80
Flux	40lm	IP Rating	IP20
Beam Angle	120°	Body Color	Silver
Battery	2*AAA	Dimension	64x43x15mm

 SKU: 233 ■ 4500K
 SKU: 234 ■ 3000K

2*AAA Battery



40 Lumens IP20

NEW PRODUCT

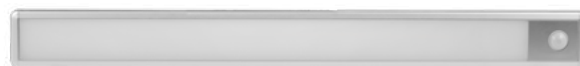
LED CABINET LIGHT
Slim Fit 3.5W

Voltage	DC:5V	CRI	Ra>80
Flux	230lm	IP Rating	IP20
Beam Angle	120°	Body Color	Silver
Battery	3.7V 2.2Ah	Dimension	600x40x10mm

 SKU: 243
 ■ 3000K

Battery Sensor



230 Lumens IP20

NEW PRODUCT

LED CABINET LIGHT
Hanging/Stand 0.5W

Voltage	DC:1.5V	CRI	Ra>80
Flux	40lm	IP Rating	IP20
Beam Angle	120°	Body Color	Silver
Battery	3*AAA	Dimension	φ80x23mm

 SKU: 235 ■ 4500K
 SKU: 236 ■ 3000K

3*AAA Battery Sensor



40 Lumens IP20



Step outside with our great range of outdoor lighting solutions. Whether you're looking to light up your garden with exterior use wall lights or increase your home's safety with security lights.

Features:

- Up to 80% power saving
- garden or park use
- Different forms, shapes and colours
- Discrete, spot or main lighting
- With or without bulbs

Application:

- Wall or pylon mountable
- Lanes, alleys or pathways
- Gardens and parks



LED OUTDOOR LIGHT

LED OUTDOOR LIGHT

NEW PRODUCT



LED SOLAR WALL LIGHT

Solar Panel Power: 5.5V 1.8W500
Lumens

IP54

Voltage	5.5V	CRI	Ra>80
Flux	500lm	IP Rating	IP54
Beam Angle	60°	Body Color	Black
Battery	3.2V 2Ah	Dimension	160x130x28mm

SKU: 7541
■ 6000K

Battery



Sensor



Solar Power

NEW PRODUCT



LED SOLAR WALL LIGHT

Solar Panel Power: 5.5V 5W1000
Lumens

IP54

Voltage	5.5V	CRI	Ra>80
Flux	1000lm	IP Rating	IP54
Beam Angle	60°	Body Color	Black
Battery	3.2V 4Ah	Dimension	350x140x28mm

SKU: 7542
■ 6000K

Battery



Sensor



Solar Power

NEW PRODUCT



LED SOLAR WALL LIGHT

Solar Panel Power: 5V 12.5W1200
Lumens

IP54

Voltage	5V	CRI	Ra>80
Flux	1200lm	IP Rating	IP54
Beam Angle	60°	Body Color	Black
Battery	3.2V 6Ah	Dimension	350x266x28mm

SKU: 7543
■ 6000K

Battery



Sensor



Solar Power

NEW PRODUCT



LED WALL LAMP 7W

Aluminium Body490
Lumens

IP54

Power	7W	CRI	Ra>80
Voltage	AC: 220-240V	IP Rating	IP54
Flux	490lm	Body Color	Black
Beam Angle	60°	Dimension	160x130x28mm

SKU: 9343
■ 2700K

NEW PRODUCT



LED SOLAR WALL LIGHT

9W400
Lumens

IP44

Voltage	5V	CRI	Ra>80
Flux	400lm	IP Rating	IP54
Beam Angle	110°	Body Color	Dark Grey
Battery	3.7V 2Ah	Dimension	160x130x190mm

SKU: 9345
■ 3000K

Battery



Sensor



Solar Power

NEW PRODUCT



LED SOLAR WALL LIGHT

9W400
Lumens

IP54

Voltage	5V	CRI	Ra>80
Flux	400lm	IP Rating	IP44
Beam Angle	110°	Body Color	Dark Grey
Battery	3.7V 2Ah	Dimension	180x120x127mm

SKU: 9347
■ 3000K

Battery



Sensor



Solar Power



SKU: 7422 Stainless Steel



SKU: 7423 Stainless Steel

Wall Lamp Fitting
E27 Holder

Product code	WL1-A1	IP Rating	IP44
Socket	E27	Dimension	303x100x91 mm
Input Voltage	AC : 220-240V	Body Colors	Stainless Steel
Material	Aluminium	Max Power	16W



E27 Holder



IP44

LED Wall Light Fitting
GU10 Socket

Product code	WL2-A3
Socket	GU10
Input Voltage	AC : 220-240V
Material	Aluminium

IP Rating	IP44
Dimension	100x66x92 mm
Body Colors	Black ; White ; Silver
Max Power	35W



GU10 Holder



IP44

SKU: 7443 Black Body

SKU: 7444 White Body

SKU: 7445 Silver Body

Wall Lamp Fitting
E27 Holder

Product code	WL1-A1	IP Rating	IP44
Socket	E27	Dimension	245x180x93 mm
Input Voltage	AC : 220-240V	Body Colors	Black ; White
Material	Aluminium+Glass	Max Power	60W



E27 Holder



IP44

SKU: 7401 Black Body

SKU: 7402 White Body

LED Wall Light Fitting
Two GU10 Sockets

Product code	WL2-A4
Socket	2xGU10
Input Voltage	AC : 220-240V
Material	Aluminium

IP Rating	IP44
Dimension	92x68x150 mm
Body Colors	Black ; White ; Silver
Max Power	2x35W



GU10 Holder



IP44

SKU: 7446 Black Body

SKU: 7447 White Body

SKU: 7448 Silver Body

LED Wall Light Fitting
GU10 Socket

Product code	WL2-A1	IP Rating	IP54
Socket	GU10	Dimension	92x68x80 mm
Input Voltage	AC : 220-240V	Body Colors	Black ; White ; Silver ; Polished
Material	Aluminium	Max Power	35W

SKU: 7431	Black Body
SKU: 7432	White Body
SKU: 7433	Silver Body
SKU: 7449	Polished

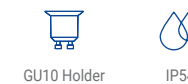
LED Wall Light Fitting
GU10 Socket

Product code	WL2-A1	IP Rating	IP54
Socket	GU10	Dimension	100x66x92 mm
Input Voltage	AC : 220-240V	Body Colors	Black ; White ; Grey
Material	Aluminium	Max Power	35W

SKU: 7434	Black Body
SKU: 7435	White Body
SKU: 7436	Grey Body

LED Wall Light Fitting
Two GU10 Sockets

Product code	WL2-A2	IP Rating	IP54
Socket	2xGU10	Dimension	92x68x150 mm
Input Voltage	AC : 220-240V	Body Colors	Black ; White ; Silver ; Polished
Material	Aluminium	Max Power	2x35W

SKU: 7437	Black Body
SKU: 7438	White Body
SKU: 7439	Silver Body
SKU: 7450	Polished

LED Wall Light Fitting
Two GU10 Sockets

Product code	WL2-A2	IP Rating	IP54
Socket	2xGU10	Dimension	92x68x150 mm
Input Voltage	AC : 220-240V	Body Colors	Black ; White ; Grey
Material	Aluminium	Max Power	2x35W

SKU: 7440	Black Body
SKU: 7441	White Body
SKU: 7442	Grey Body



LED SOLAR POWER GARDEN LIGHT



LED SOLAR GARDEN LIGHT
Solar Panel Power: 5.5V 0.6W



Voltage	5.5V	CRI	Ra>80
Flux	8lm	IP Rating	IP65
Beam Angle	120°	Body Color	Black
Battery	3.7V 2Ah	Dimension	165x165x31.5mm

Wall Mounted or Pin Mounted

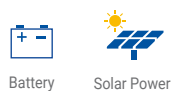

LED SOLAR GARDEN LIGHT
Solar Panel Power: 5.5V 0.6W

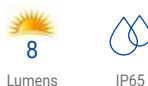

Voltage	5.5V	CRI	Ra>80
Flux	8lm	IP Rating	IP65
Beam Angle	120°	Body Color	Black
Battery	3.7V 2Ah	Dimension	165x165x31.5mm

Wall Mounted or Pin Mounted



LED Light Fixture
GU10 Socket



Product code	WL2-A2	IP Rating	IP65
Socket	1xGU10	Dimension	92x68x150 mm
Input Voltage	AC : 220-240V	Body Colors	Black
Material	PC	Max Power	35W

SKU: 2084 GU10-Black



LED SOLAR LAMP
1.5W Lawn Light

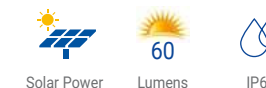

Watts	1.5W	CRI	Ra>80
Voltage	6V	IP Rating	IP65
Flux	60lm	Material	Aluminium
Beam Angle	110°	Body Color	Black
Battery	1.2V/1500mAh	Dimension	168x75.5x340 mm

- SKU: 9321 6000K
- SKU: 9322 3000K
- SKU: 9323 Blue Light
- SKU: 9324 Green Light

CHARGING TIME~(7-8) Hours
DETECTION RANGE~8±2m



LED SOLAR LAMP
0.75W Wall Light



Product code	WL2-A6	CRI	Ra>80
Watts	0.75W	IP Rating	IP54
Voltage	5.5V	Material	ABS+PC
Flux	110lm	Body Color	Black
Beam Angle	110°	Dimension	124x95x48mm
Battery	1200mAh		

SKU: 7405 White Light 6000K

CHARGING TIME~(7-8) Hours
DETECTION RANGE~8±2m



LED SOLAR LAMP
1.5W Wall Light



Product code	WL5-A6	CRI	Ra>80
Watts	1.5W	IP Rating	IP54
Voltage	7.4V	Material	ABS+PC
Flux	150lm	Body Color	Black
Beam Angle	110°	Dimension	196x115x45mm
Battery	1200mAh		

SKU: 7406 6000K

CHARGING TIME~(7-8) Hours
DETECTION RANGE~8±2m



LED SOLAR GARDEN LIGHT
Solar Panel Power: 5.5V 1W

60 Lumens IP54

Voltage	5.5V	CRI	Ra>80
Flux	60lm	IP Rating	IP54
Beam Angle	270°	Body Color	Black
Battery	3.7V 1.2Ah	Dimension	180x116x740mm

Table Way or Pin Mounted

SKU: 9349
CCT
6000K 4000K 3000K



LED SOLAR WALL LIGHT
0.5W

40 Lumens IP44

Voltage	3.7V	CRI	Ra>80
Flux	40lm	IP Rating	IP44
Beam Angle	120°	Body Color	Black
Battery	3.7V 1.2Ah	Dimension	105x70x40mm

SKU: 9352
3000K

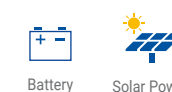

LED SOLAR GARDEN LIGHT
Solar Panel Power: 5.5V 1W

60 Lumens IP54

Voltage	5.5V	CRI	Ra>80
Flux	60lm	IP Rating	IP54
Beam Angle	270°	Body Color	Black
Battery	3.7V 1.2Ah	Dimension	230x116x150mm

Table Way or Wall Mounted

SKU: 9350
CCT
6000K 4000K 3000K

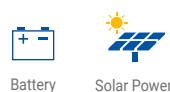

LED SOLAR LIGHT SPIKE
2W

160 Lumens IP65

Voltage	3.7V	CRI	Ra>80
Flux	160lm	IP Rating	IP65
Beam Angle	120°	Body Color	Black
Battery	3.7V 1.8Ah	Dimension	102x169x313mm

Light Brigness Control

SKU: 9353
3000K

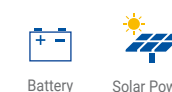

LED SOLAR GARDEN LIGHT
Solar Panel Power: 5V 1.8W

70 Lumens IP54

Voltage	5.5V	CRI	Ra>80
Flux	70lm	IP Rating	IP54
Beam Angle	270°	Body Color	Black
Battery	3.7V 1.2Ah	Dimension	160x160x213mm

Remote Control

SKU: 9351
CCT
6000K 4000K 3000K

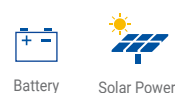

LED SOLAR LIGHT SPIKE
1W

80 Lumens IP65

Voltage	3.7V	CRI	Ra>80
Flux	80lm	IP Rating	IP65
Beam Angle	120°	Body Color	Black
Battery	3.7V 1.2Ah	Dimension	φ130x395mm

Light Brigness Control

SKU: 9354
3000K

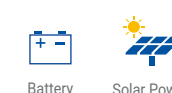

LED SOLAR LIGHT SPIKE
Solar Panel Power: 5V 1W

Voltage	3.2V	CRI	Ra>80
Flux	90lm	IP Rating	IP65
Beam Angle	60°	Body Color	Black
Battery	3.2V 1.2Ah	Dimension	φ126x51.8mm

 SKU: 9357
 ■ 6000K

 2 PCS
 Box

LED SOLAR LIGHT SPIKE
Solar Panel Power: 5V 1W

Voltage	3.2V	CRI	Ra>80
Flux	90lm	IP Rating	IP65
Beam Angle	60°	Body Color	Black
Battery	3.2V 1.2Ah	Dimension	φ126x51.8mm

 SKU: 9358
 ■ 4000K

 2 PCS
 Box

LED SOLAR LIGHT SPIKE
Solar Panel Power: 5V 1W

Voltage	3.2V	CRI	Ra>80
Flux	90lm	IP Rating	IP65
Beam Angle	60°	Body Color	Black
Battery	3.2V 1.2Ah	Dimension	φ126x51.8mm

 SKU: 9359
 ■ RGB

 2 PCS
 Box

LED LAWN LIGHT 7W
Aluminium Body

Power	7W	CRI	Ra>80
Voltage	AC: 220-240V	IP Rating	IP54
Flux	490lm	Body Color	Dark Grey
Beam Angle	150°	Dimension	φ123x800mm

 SKU: 9344
 ■ 3000K

LED SOLAR LAMP
9W

Voltage	3.7V	CRI	Ra>80
Flux	400lm	IP Rating	IP44
Beam Angle	110°	Body Color	Dark Grey
Battery	3.7V 2Ah	Dimension	150x195x762mm

 SKU: 9346
 ■ 3000K

LED SOLAR LAMP
9W

Voltage	3.7V	CRI	Ra>80
Flux	400lm	IP Rating	IP44
Beam Angle	110°	Body Color	Dark Grey
Battery	3.7V 2Ah	Dimension	150x195x762mm

 SKU: 9348
 ■ 3000K

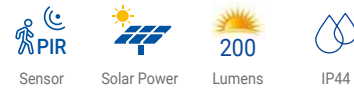

LED SOLAR LAMP
2W Wall Light

Watts	2W	CRI	Ra>80
Voltage	3.7V	IP Rating	IP44
Flux	200lm	Material	Aluminium
Beam Angle	110°	Body Color	SS Brushed
Battery	3.7V/1200mAh	Dimension	142x125x188mm

 SKU: 9331
 ■ 3000K

 CHARGING TIME~(7-8) Hours
 DETECTION RANGE~8±2m

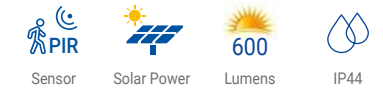
LED SOLAR LAMP
4.4W Wall Light

Watts	4.4W	CRI	Ra>80
Voltage	3.7V	IP Rating	IP44
Flux	600lm	Material	Aluminium
Beam Angle	110°	Body Color	SS Brushed
Battery	3.7V/2600mAh	Dimension	173x160x155mm

 SKU: 9334
 ■ 3000K

 CHARGING TIME~(7-8) Hours
 DETECTION RANGE~8±2m

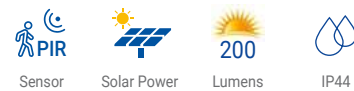
LED SOLAR LAMP
2W Lawn Spike

Watts	2W	CRI	Ra>80
Voltage	3.7V	IP Rating	IP44
Flux	200lm	Material	Aluminium
Beam Angle	110°	Body Color	SS Brushed
Battery	3.7V/1200mAh	Dimension	125x125x500mm

 SKU: 9332
 ■ 3000K

 CHARGING TIME~(7-8) Hours
 DETECTION RANGE~8±2m

LED SOLAR LAMP
4.4W Lawn Spike

Watts	4.4W	CRI	Ra>80
Voltage	3.7V	IP Rating	IP44
Flux	600lm	Material	Aluminium
Beam Angle	110°	Body Color	SS Brushed
Battery	3.7V/2600mAh	Dimension	160x160x500mm

 SKU: 9335
 ■ 3000K

 CHARGING TIME~(7-8) Hours
 DETECTION RANGE~8±2m

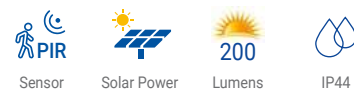
LED SOLAR LAMP
2W Lawn Light

Watts	2W	CRI	Ra>80
Voltage	3.7V	IP Rating	IP44
Flux	200lm	Material	Aluminium
Beam Angle	110°	Body Color	SS Brushed
Battery	3.7V/1200mAh	Dimension	125x125x800mm

 SKU: 9333
 ■ 3000K

 CHARGING TIME~(7-8) Hours
 DETECTION RANGE~8±2m

LED SOLAR LAMP
4.4W Lawn Light

Watts	4.4W	CRI	Ra>80
Voltage	3.7V	IP Rating	IP44
Flux	600lm	Material	Aluminium
Beam Angle	110°	Body Color	SS Brushed
Battery	3.7V/2600mAh	Dimension	142x125x188mm

 SKU: 9336
 ■ 3000K

 CHARGING TIME~(7-8) Hours
 DETECTION RANGE~8±2m

LED SOLAR LAMP
4.4W Wall Light

Watts	4.4W	CRI	Ra>80
Voltage	3.7V	IP Rating	IP44
Flux	600lm	Material	Aluminium
Beam Angle	110°	Body Color	SS Brushed
Battery	3.7V/2600mAh	Dimension	162x150x155mm

 SKU: 9337
 3000K

 CHARGING TIME~(7-8) Hours
 DETECTION RANGE~8±2m

LED SOLAR LAMP
6W Wall Light

Watts	6W	CRI	Ra>80
Voltage	3.7V	IP Rating	IP44
Flux	600lm	Material	Aluminium
Beam Angle	110°	Body Color	Black
Battery	3.7V/2200mAh	Dimension	173x160x155mm

 SKU: 9340
 6000K

 CHARGING TIME~(7-8) Hours
 DETECTION RANGE~8±2m

LED SOLAR LAMP
4.4W Lawn Spike

Watts	4.4W	CRI	Ra>80
Voltage	3.7V	IP Rating	IP44
Flux	600lm	Material	Aluminium
Beam Angle	110°	Body Color	SS Brushed
Battery	3.7V/2600mAh	Dimension	150x150x500mm

 SKU: 9338
 3000K

 CHARGING TIME~(7-8) Hours
 DETECTION RANGE~8±2m

LED SOLAR LAMP
6W Lawn Light 50cm

Watts	6W	CRI	Ra>80
Voltage	3.7V	IP Rating	IP44
Flux	600lm	Material	Aluminium
Beam Angle	110°	Body Color	Black
Battery	3.7V/2200mAh	Dimension	150x150x500mm

 SKU: 9341
 6000K

 CHARGING TIME~(7-8) Hours
 DETECTION RANGE~8±2m

LED SOLAR LAMP
4.4W Lawn Light

Watts	4.4W	CRI	Ra>80
Voltage	3.7V	IP Rating	IP44
Flux	600lm	Material	Aluminium
Beam Angle	110°	Body Color	SS Brushed
Battery	3.7V/2600mAh	Dimension	150x150x800mm

 SKU: 9339
 3000K

 CHARGING TIME~(7-8) Hours
 DETECTION RANGE~8±2m

LED SOLAR LAMP
6W Lawn Light 90cm

Watts	6W	CRI	Ra>80
Voltage	3.7V	IP Rating	IP44
Flux	600lm	Material	Aluminium
Beam Angle	110°	Body Color	Black
Battery	3.7V/2200mAh	Dimension	150x150x900mm

 SKU: 9342
 6000K

 CHARGING TIME~(7-8) Hours
 DETECTION RANGE~8±2m



Wall Lamp Up
E27 Holder



Product code	GD1-A1	IP Rating	IP44
Socket	E27	Dimension	215x170x220 mm
Input Voltage	AC : 220-240V	Body Colors	Black ; White
Material	Aluminium+PC	Max Power	60W

SKU: 9301 Black Body
SKU: 9302 White Body



Stand Lamp
E27 Holder



Product code	GD1-A2	IP Rating	IP44
Socket	E27	Dimension	170x170x290 mm
Input Voltage	AC : 220-240V	Body Colors	Black ; White
Material	Aluminium+PC	Max Power	60W

SKU: 9305 Black Body
SKU: 9306 White Body



Wall Lamp Down
E27 Holder



Product code	GD1-A1	IP Rating	IP44
Socket	E27	Dimension	215x170x220 mm
Input Voltage	AC : 220-240V	Body Colors	Black ; White
Material	Aluminium+PC	Max Power	60W

SKU: 9303 Black Body
SKU: 9304 White Body



Ceiling Lamp
E27 Holder



Product code	GD1-A3	IP Rating	IP44
Socket	E27	Dimension	170x170x740 mm
Input Voltage	AC : 220-240V	Body Colors	Black ; White
Material	Aluminium+PC	Max Power	60W

SKU: 9307 Black Body
SKU: 9308 White Body



Lawn Lamp 60cm
E27 Holder

Product code	GD1-A1	IP Rating	IP44
Socket	E27	Dimension	170x170x600 mm
Input Voltage	AC : 220-240V	Body Colors	Black ; White
Material	Aluminium+PC	Max Power	60W



E27 Holder



IP44

SKU: 9309 Black Body

SKU: 9310 White Body



Lawn Lamp 90cm
E27 Holder

Product code	GD1-A1	IP Rating	IP44
Socket	E27	Dimension	170x170x900 mm
Input Voltage	AC : 220-240V	Body Colors	Black ; White
Material	Aluminium+PC	Max Power	60W



E27 Holder



IP44

SKU: 9311 Black Body

SKU: 9312 White Body



Lawn Lamp
E27 Holder

Product code	GD1-A7	IP Rating	IP54
Socket	E27	Dimension	76x76x800/1000 mm
Input Voltage	AC : 220-240V	Body Colors	Grey
Material	Aluminium+PC	Max Power	16W



E27 Holder



IP54

SKU: 9315 Grey Body 80cm

SKU: 9316 Grey Body 100cm



1W



7W



1W

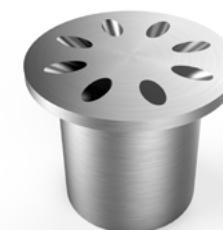

1.3W

Powerful LED Pond Wall Lights

LED Light 1.3W ; 7W



Product code	UN1-A5	IP Rating	IP68
Power	1.3W ; 7W	Dimension	60 x 60 x 78 mm
Voltage	DC:24V		

- SKU: 590 1W ■ 3000K
- SKU: 856 7W ■ 4200K

Decorative Mini LED Pond Wall Lights

LED Light 1-1.3W



Product code	UN1-A6	IP Rating	IP68
Power	1W -1.3W	Dimension	35 x 28 mm
Voltage	DC:24V		

- SKU: 591 ■ RGB
- SKU: 594 ■ 6000K
- SKU: 595 ■ 3000K



Mini Wall & Floor Lights

LED Light 1.2W

Product code	UN1-A5	IP Rating	IP68
Power	1.2W	Dimension	38 x 30 mm
Voltage	DC:24V		

- SKU: 586 ■ 6000K
- SKU: 587 ■ 3000K
- SKU: 588 ■ Blue
- SKU: 589 ■ RGB



1W



1.3W

Powerful LED Pond Wall Light

LED Light 1W-1.3W

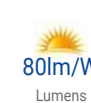

Product code	UN1-A9	IP Rating	IP68
Power	1W-1.3W	Dimension	32 x 44 mm
Voltage	DC:24V		

- SKU: 565 ■ RGB
- SKU: 566 ■ Blue
- SKU: 567 ■ Green
- SKU: 568 ■ Amber



1 Side Beam



2 Side Beam

Mini Directional Ground Lights

LED Light 1.3W

Product code	UN1-A8	IP Rating	IP68
Power	1.3W	Dimension	44 x 43 mm
Voltage	DC:24V		



- SKU: 596 6000K 1 Side Beam
- SKU: 597 3000K 1 Side Beam
- SKU: 598 6000K 2 Side Beam
- SKU: 599 3000K 2 Side Beam



1W



1.3W

LED Mini Floor Lights

LED Light 1-1.3W

Product code	UN1-A3	IP Rating	IP68
Power	1W -1.3W	Dimension	23 x 40 mm
Voltage	DC:24V		



- SKU: 580 1W 6000K
- SKU: 581 1W 3000K
- SKU: 582 1W Blue
- SKU: 583 1.3W 6000K
- SKU: 584 1.3W 3000K
- SKU: 585 1.3W Blue



LED Spike Lights
LED Light 1.3W

Product code	UN1-A5	IP Rating	IP68
Power	1.3W	Dimension	38 x 30 mm
Voltage	DC:24V		



- SKU: 866 6000K
- SKU: 867 4000K
- SKU: 868 3000K



Sleeve for LED Underground Lights

- SKU: 873 Size - 22*55MM
- SKU: 872 Size - 55*150MM
- SKU: 874 Size - 35*150MM



Mini Ground Lights
HALF-SHADING 1.3W

Product code	UN1-A6	IP Rating	IP68
Power	1.3W	Dimension	60 x 45 mm
Voltage	DC:24V		

- SKU: 592 6000K
- SKU: 593 3000K



Mini Recessed Wall Lights
LED Light 1W

Product code	UN1-A6	IP Rating	IP44
Power	1W	Dimension	64 x 43 mm
Voltage	DC:24V		

- SKU: 863 6000K
- SKU: 864 4000K
- SKU: 865 3000K
- SKU: 879 Blue



**LED Pool Light
12W PAR56**
 **1200**
Lumens
  90°
  IP68

Product code	PL12-A1	CRI	Ra>80
Watts	12W	IP Rating	IP68
Input Voltage	AC/DC :12V	Dimension	ø178x114 mm
Flux	1200lm	Body	Glass
Beam Angle	90°	Dimmable	NO
Socket	PAR56		



SKU: 571  6000KSKU: 572  2700K
OSRAM
Chips

With Remote

**LED Pool Light
12W PAR56**
 **1200**
Lumens
  90°
  IP68

Product code	PL12-A1	CRI	Ra>80
Watts	12W	IP Rating	IP68
Input Voltage	AC/DC :12V	Dimension	ø178x114 mm
Flux	1200lm	Body	Glass
Beam Angle	90°	Dimmable	NO
Socket	PAR56		

SKU: 573 
EPISTAR
Chips

**LED Outdoor Light
1W Spotlight**
 **80**
Lumens
  ø58mm
  18°
  IP65

Watts	1W
Input Voltage	AC : 220-245V
Flux	80lm
Beam Angle	18°

CRI	Ra>80
IP Rating	IP65
Dimension	ø65x78mm
Body Color	Stainless steel

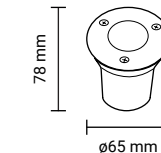
SKU: 507  6000KSKU: 517  2800K
**LED Outdoor Light
3W Spotlight**
 **240**
Lumens
  ø90mm
  18°
  IP65

Watts	3W
Input Voltage	AC : 220-245V
Flux	240lm
Beam Angle	18°

CRI	Ra>80
IP Rating	IP65
Dimension	ø100x82mm
Body Color	Stainless steel

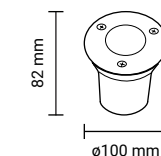
SKU: 501  6000KSKU: 502  2800K
**LED Outdoor Light
5W Spotlight**
 **400**
Lumens
  ø132mm
  18°
  IP65

Watts	5W
Input Voltage	AC : 220-245V
Flux	400lm
Beam Angle	18°

CRI	Ra>80
IP Rating	IP65
Dimension	ø140x93 mm
Body Color	Stainless steel

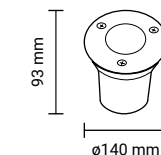
SKU: 515  6000KSKU: 516  2800K
**LED Outdoor Light
7W Spotlight**
 **560**
Lumens
  ø132mm
  18°
  IP65

Watts	7W
Input Voltage	AC : 220-245V
Flux	560lm
Beam Angle	18°

CRI	Ra>80
IP Rating	IP65
Dimension	ø150x93 mm
Body Color	Stainless steel

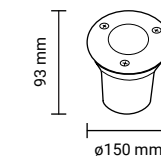
SKU: 550  6000KSKU: 551  2800K

Outdoor Solar String Lights



Outdoor Solar String Lights- Milky
G50 Bulbs 20 pcs -10 Meters

SKU: 9092
2700K

128
Lumens

Solar Power

IP65



Battery

3.7V 0.5Ah



Outdoor Solar String Lights- Clear
G50 Bulbs 20 pcs -10 Meters

SKU: 9093
2700K

128
Lumens

Solar Power

IP65



Battery

3.7V 0.5Ah



Outdoor Solar String Lights- Milky
G50 Bulbs 20 pcs - 7 Meters
- 8 Modes

SKU: 9094
2700K

200
Lumens

Solar Power

IP65



Battery

3.7V 0.5Ah



Outdoor Solar String Lights- Clear
G50 Bulbs 20 pcs - 7 Meters
- 8 Modes

SKU: 9095
2700K

200
Lumens

Solar Power

IP65



Battery

3.7V 0.5Ah



Outdoor String Lights

E27 Holders OT1-A3

- * 6 or 14.4 Meters Long String
- * 10 or 15 Pcs E27 Sockets
- * Up to 5A
- * Suspended Sockets
- * IP65
- * Black Color

SKU: 5054 10pcs E27 - 6m

SKU: 5051 15pcs E27 - 14.4m



E27 Holder



IP65



Outdoor String Lights

E27 Holders OT1-A3

- * 6 or 14.4 Meters Long String
- * 10 or 15 Pcs E27 Sockets
- * Up to 5A
- * Fixed Sockets
- * IP65
- * White Color

SKU: 5055 10pcs E27 - 6m

SKU: 5053 15pcs E27 - 14.4m



E27 Holder



IP65



Outdoor String Lights

E27 Holders OT1-A3

- * 14.4 Meters Long String
- * 15 Pcs E27 Sockets
- * Up to 5A
- * Fixed Sockets
- * IP65
- * Black Color

SKU: 5052 15pcs E27 - 14.4m



E27 Holder



IP65



Outdoor String Lights

Colourful Bulbs

- * 8 or 13 Meters Long String
- * 10 or 20 Bulbs included
- * 0.5 Watts Per Bulb
- * IP65
- * Black Color

SKU: 5056 10pcs Bulbs - 8m - 3W Colourful Bulbs

SKU: 5092 20pcs Bulbs - 13m - 6W Colourful Bulbs



IP65



Linkable up to 2 Strings



Outdoor String Lights

Colourful Bulbs

- * 8 or 13 Meters Long String
- * 10 or 20 Bulbs included
- * 0.5 Watts Per Bulb
- * IP65
- * White Color

SKU: 5090 10pcs Bulbs - 8m - 3W Colourful Bulbs

SKU: 5095 20pcs Bulbs - 13m - 6W Colourful Bulbs



IP65



Linkable up to 2 Strings



Outdoor String Lights

With Bulbs

- * 8 or 13 Meters Long String
- * 10 or 20 Bulbs included
- * 0.5 Watts Per Bulb
- * IP65
- * Black Color

SKU: 5057 10pcs Bulbs - 8m - 3W ■ 6000KSKU: 5058 10pcs Bulbs - 8m - 3W ■ 2700KSKU: 5093 20pcs Bulbs - 13m - 6W ■ 6000KSKU: 5094 20pcs Bulbs - 13m - 6W ■ 2700K

IP65



Linkable up to 2 Strings



Outdoor String Lights

With Bulbs

- * 8 or 13 Meters Long String
- * 10 or 20 Bulbs included
- * 0.5 Watts Per Bulb
- * IP65
- * White Color

SKU: 5091 10pcs Bulbs - 8m - 3W ■ 2700KSKU: 5096 20pcs Bulbs - 13m - 6W ■ 2700K

IP65



Linkable up to 2 Strings



A universe of possibilities when combining the existing lighting solutions with various detecting devices to further enable energy saving and efficiency.

Features:

- Up to 80% power saving
- Home, office, garden or park use
- Different forms, shapes and colours
- Easy installation and long lifecycle

Application:

- Wall or pylon mountable

LED MOTION SENSORS

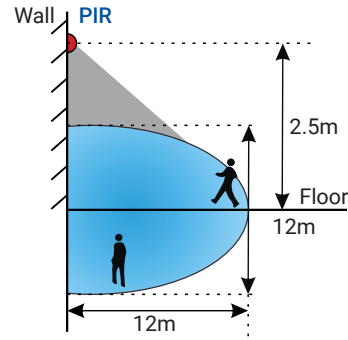

PIR Motion Sensor

Product code	SE1-A1	Body Color	White
Input Voltage	AC:110-240V	Class	II
Beam Angle	180°	Time	10sec-7min
Range	12m Max	Max Power	300W LED
Frequency	50-60 Hz	Ambient Light	<10Lux-2000Lux
Working Temp.	-30°C/+50°C	Material	Plastic+ALU
IP Rating	IP44	Dimension	ø65x86.5mm



SKU: 7301 White Body

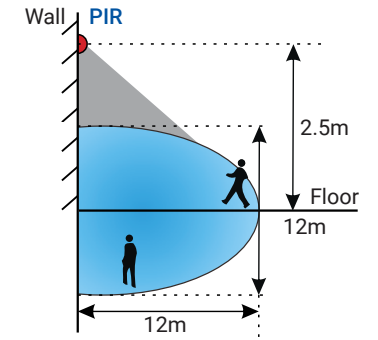

PIR Motion Sensor

Product code	SE1-A3	Body Color	White
Input Voltage	AC:110-240V	Class	II
Beam Angle	180°	Time	10sec-7min
Range	12m Max	Max Power	200W LED
Frequency	50-60 Hz	Ambient Light	<10Lux-2000Lux
Working Temp.	-30°C/+50°C	Material	Plastic+ALU
IP Rating	IP54	Dimension	ø77x70mm



SKU: 7306 White Body

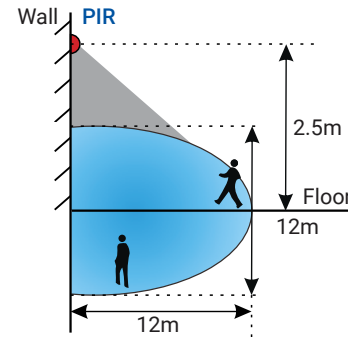

PIR Motion Sensor

Product code	SE1-A1	Body Color	Black
Input Voltage	AC:110-240V	Class	II
Beam Angle	180°	Time	10sec-7min
Range	12m Max	Max Power	300W LED
Frequency	50-60 Hz	Ambient Light	<10Lux-2000Lux
Working Temp.	-30°C/+50°C	Material	Plastic+ALU
IP Rating	IP44	Dimension	ø65x86.5mm



SKU: 7302 Black Body 3800156673021

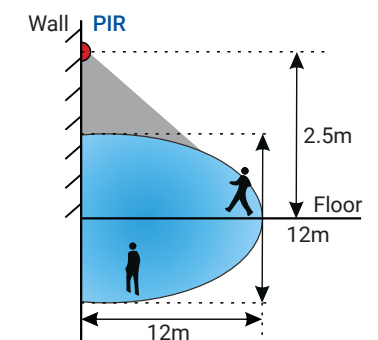

PIR Motion Sensor

Product code	SE1-A3	Body Color	Black
Input Voltage	AC:110-240V	Class	II
Beam Angle	180°	Time	10sec-7min
Range	12m Max	Max Power	200W LED
Frequency	50-60 Hz	Ambient Light	<10Lux-2000Lux
Working Temp.	-30°C/+50°C	Material	Plastic+ALU
IP Rating	IP54	Dimension	ø77x70mm



SKU: 7307 Black Body

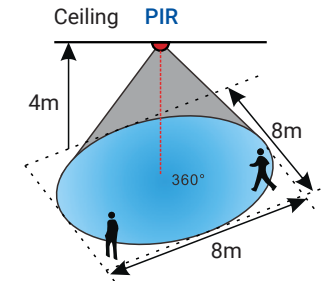
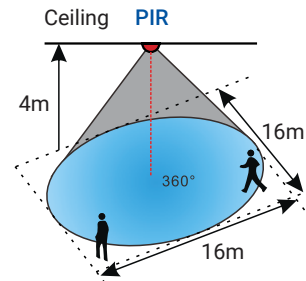

PIR Motion Sensor

Product code	SE1-A2	Body Color	White
Input Voltage	AC:110-240V	Class	II
Beam Angle	360°	Time	10sec-7min
Range	16m Max	Max Power	300W LED
Frequency	50-60 Hz	Ambient Light	<10Lux-2000Lux
Working Temp.	-30°C/+50°C	Material	Plastic+ALU
IP Rating	IP20	Dimension	∅88x55.5mm



SKU: 7305 White Body

PIR Motion Sensor

Product code	SE1-A2	Body Color	White
Input Voltage	AC:110-240V	Class	II
Beam Angle	360°	Time	10sec-7min
Range	8m Max	Max Power	1000W LED
Frequency	50-60 Hz	Ambient Light	<10Lux-2000Lux
Working Temp.	-30°C/+50°C	Material	Plastic+ALU
IP Rating	IP20	Dimension	∅108x25mm



SKU: 7310 White Body

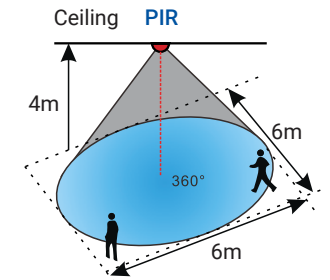
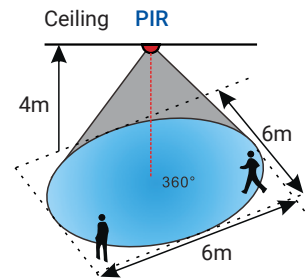

PIR Motion Sensor

Product code	SE1-A2	Body Color	White
Input Voltage	AC:220-240V	Class	II
Beam Angle	360°	Time	10sec-7min
Range	6m Max	Max Power	300W LED
Frequency	50-60 Hz	Ambient Light	<10Lux-2000Lux
Working Temp.	-30°C/+50°C	Material	Plastic+ALU
IP Rating	IP20	Dimension	∅76x58mm



SKU: 7317 White Body
SKU: 7320 Black Body
SKU: 7321 Gray Body

PIR Motion Sensor

Product code	SE1-A2	Body Color	White
Input Voltage	AC:110-240V	Class	II
Beam Angle	360°	Time	10sec-7min
Range	6m Max	Max Power	1000W LED
Frequency	50-60 Hz	Ambient Light	<10Lux-2000Lux
Working Temp.	-30°C/+50°C	Material	Plastic+ALU
IP Rating	IP20	Dimension	∅65x86.5mm



SKU: 7311 White Body

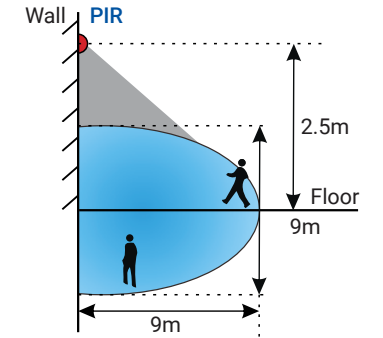
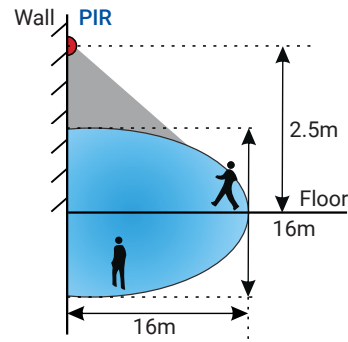

PIR Motion Sensor

Functions: D2D: DUSK TO DAWN

Product code	SE1-A2	Body Color	Black
Input Voltage	AC:220-240V	Class	II
Beam Angle	180°	Time	10sec-10min
Range	16m Max	Max Power	400W LED
Frequency	50-60 Hz	Ambient Light	<10Lux-2000Lux
Working Temp.	-30°C/+50°C	Material	Plastic+ALU
IP Rating	IP54		



SKU: 7318 Black Body

PIR Motion Sensor

Product code	SE1-A2	Body Color	White
Input Voltage	AC:220-240V	Class	II
Beam Angle	160°	Time	10sec-7min
Range	9m Max	Max Power	400W LED
Frequency	50-60 Hz	Ambient Light	<10Lux-2000Lux
Working Temp.	-30°C/+50°C	Material	Plastic+ALU
IP Rating	IP20		



SKU: 7322 White Body

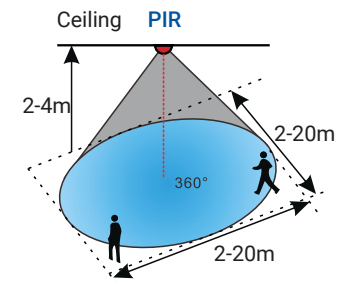
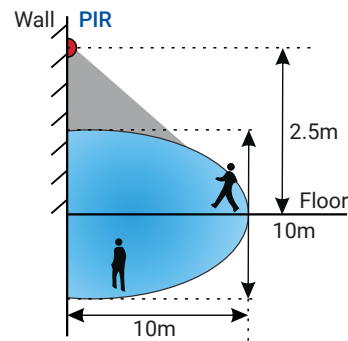

PIR Motion Sensor

Product code	SE1-A2	Body Color	White
Input Voltage	AC:220-240V	Class	II
Beam Angle	120°	Time	10sec-7min
Range	10m Max	Max Power	300W LED
Frequency	50-60 Hz	Ambient Light	<10Lux-2000Lux
Working Temp.	-30°C/+50°C	Material	Plastic+ALU
IP Rating	IP44		



SKU: 7319 White Body

PIR Motion Sensor

Product code	SE1-A2	Body Color	White
Input Voltage	AC:220-240V	Class	II
Beam Angle	360°	Time	5sec-10min
Range	20m Max	Max Power	1000W LED
Frequency	50-60 Hz	Ambient Light	<10Lux-2000Lux
Working Temp.	-30°C/+50°C	Material	Plastic+ALU
IP Rating	IP20	Dimension	ø65x86.5mm



SKU: 7323 White Body



ON/OFF via moving hand



Dimming + Driver
5.8 Ghz

Short Distance IR

Product code	SE1-A2	Body Color	White
Input Voltage	AC:110-240V	Class	II
Beam Angle	180°	Time	10sec-7min
Range	5cm Max	Max Power	200W LED
Frequency	50-60 Hz	Ambient Light	<10Lux-2000Lux
Working Temp.	-30°C/+50°C	Material	Plastic
IP Rating	IP20	Dimension	75x18mm



SKU: 7304 White Body

Microwave Sensor

Product code	SE1-A5	Body Color	White
Input Voltage	AC:110-240V	Class	II
Beam Angle	180°/ 300°	Time	10sec-30min
Range	25-100%	Max Power	300W LED
Frequency	50-60 Hz	Ambient Light	5,10,20,30,50,100,200lux
Working Temp.	-30°C/+50°C	Material	Plastic+ALU
IP Rating	IP20	Dimension	75x47mm



SKU: 7315 White Body

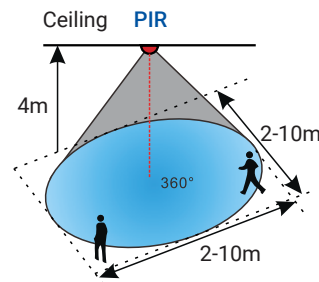

Dimming + Driver
5.8 Ghz

PIR Motion Sensor

Product code	SE1-A4	Body Color	White
Input Voltage	AC:110-240V	Class	II
Beam Angle	120°	Time	10sec-7min
Range	2-10m Max	Max Power	100W LED
Frequency	50-60 Hz	Ambient Light	<10Lux-2000Lux
Working Temp.	-30°C/+50°C	Material	Plastic+ALU
IP Rating	IP65	Dimension	57x35mm



SKU: 7309 White Body

Microwave Sensor

Product code	SE1-A5	Body Color	White
Input Voltage	AC:110-240V	Class	II
Beam Angle	180°	Time	10sec-7min
Range	3-10m Max	Max Power	300W LED
Frequency	50-60 Hz	Ambient Light	<10Lux-2000Lux
Working Temp.	-30°C/+50°C	Material	Plastic+ALU
IP Rating	IP20	Dimension	56x42mm



SKU: 7316 White Body

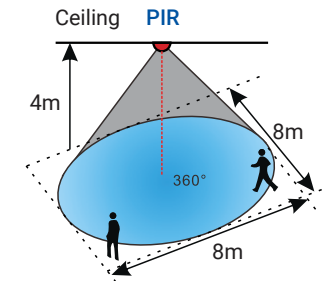

PIR Motion Sensor

Product code	SE1-A2	Body Color	White
Input Voltage	AC:110-240V	Class	II
Beam Angle	360°	Time	10sec-7min
Range	8m Max	Max Power	300W LED
Frequency	50-60 Hz	Ambient Light	<10Lux-2000Lux
Working Temp.	-30°C/+50°C	Material	Plastic+ALU
IP Rating	IP20	Dimension	∅80x62mm



SKU: 7312 White Body

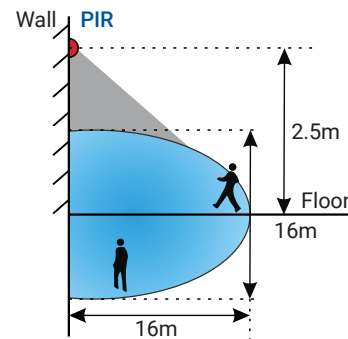

PIR Motion Sensor

Product code	SE1-A1	Body Color	White
Input Voltage	AC:110-240V	Class	II
Beam Angle	300°	Time	10sec-7min
Range	16m Max	Max Power	300W LED
Frequency	50-60 Hz	Ambient Light	<10Lux-2000Lux
Working Temp.	-30°C/+50°C	Material	Plastic+ALU
IP Rating	IP44	Dimension	165x117mm



SKU: 7313 White Body



Light Control Sensor

Product code	SE1-A1	Body Color	White+Blue
Input Voltage	AC:110-240V	Class	II
Power	6A Max	Ambient Light	<10Lux ON; >40Lux OFF
Frequency	50-60 Hz	Material	Plastic+ALU
Working Temp.	-30°C/+50°C	Dimension	46x44x35mm
IP Rating	IP44		



SKU: 7314 White Body



LED DISPLAYS AND STAGE EFFECTS



LED Displays have large variety of applications – for commercial use, information boards and other decorative purposes, with wide customization options.

Features:

- High power and flexible applications
- For commercial and public use
- Different options for resolutions
- Indoor and outdoor use
- Easy to install and maintain
- Low energy consumption

Application:

- Stadiums and concerts
- Indoor music halls
- Commercial outdoor use





LED Displays

Module Indoor

SKU: 608 P2Size
 SKU: 630 P2.5Size
 SKU: 631 P3 Size
 SKU: 601 P4 Size
 SKU: 629 P4 Size
 SKU: 602 P5 Size



DC 5V



150°



IP20

	P2	P2.5	P3	P4	 P4	P5
Pixel pitch	2 mm	2.5 mm	3 mm	4 mm	4 mm	5 mm
Module size	256x128 mm	320x160 mm	192x192 mm	256x128 mm	256x256 mm	320x160 mm
Module pixels	128x64 pixel	128x32 pixel	64x64 pixel	64x32 pixel	64x64 pixel	64x32 pixel
Brightness	2000cd/m ²	1200cd/m ²	1100cd/m ²	1100cd/m ²	2000cd/m ²	2000cd/m ²
Refresh rate	1920 Hz	1920 Hz	1920 Hz	1920 Hz	3840 Hz	1920 Hz
Drive mode	1/32 Scan	1/32 Scan	1/32 Scan	1/16 Scan	1/16 Scan	1/16 Scan
Module Power	16.5W	20W	16.5W	16.5W	33W	17W
Working Temp.	-20°C/+50°C	-20°C/+50°C	-20°C/+50°C	-20°C/+50°C	-20°C/+65°C	-20°C/+50°C
Pixel Composition	SMD 3in1 RGB	SMD 3in1 RGB	SMD 3in1 RGB	SMD 3in1 RGB	SMD 3in1 RGB	SMD 3in1 RGB
Life Span	50 000 h	50 000 h	50 000 h	50 000 h	50 000 h	50 000 h

LED Display Cabinet
Fix INDOOR Ver 2.0

SKU: 610 P3 Size
 SKU: 611 P4 Size
 SKU: 612 P5 Size



DC 5V



150°



IP20

	P3	P4	P5
Pixel pitch	3 mm	4 mm	5 mm
Display size	960x960mm	768x768mm	960x960mm
Module size	192x192mm	256x128mm	320x192mm
Brightness	2000cd/m ²	2000cd/m ²	2000cd/m ²
Pixel Density	111 111dots/ m ²	62 500dots/ m ²	40 000dots/ m ²
Drive mode	1/32 Scan	1/16 Scan	1/16 Scan
Refresh rate	1920 Hz	1920 Hz	1920 Hz
Working Temp.	-20°C/+50°C	-20°C/+50°C	-20°C/+50°C
MAX Power	750W	750W	750W
Life Span	50 000 h	50 000 h	50 000 h

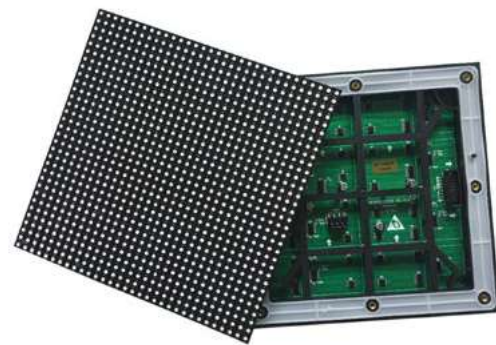

LED Displays

Module Outdoor

SKU: 609 P3 Size
 SKU: 603 P4 Size
 SKU: 604 P5 Size
 SKU: 606 P6 Size
 SKU: 605 P8 Size



DC 5V



150°



IP65

	P3	P4	P5	P6	P8
Pixel pitch	3 mm	4 mm	5 mm	6 mm	8 mm
Module size	192x192 mm	256x128 mm	320x160 mm	196x196 mm	256x128 mm
Module pixels	64x64pixel	64x32pixel	64x32 pixel	32x32 pixel	32x16 pixel
Brightness	6500cd/m ²	5500cd/m ²	5500cd/m ²	5500cd/m ²	5500cd/m ²
Refresh rate	1920 Hz	1920 Hz	1920 Hz	1920 Hz	1920 Hz
Drive mode	1/16 Scan	1/16 Scan	1/16 Scan	1/16 Scan	1/4 Scan
Module Power	35W	35W	39W	26W	27W
Working Temp.	-20°C/+50°C	-20°C/+50°C	-20°C/+50°C	-20°C/+50°C	-20°C/+50°C
Pixel Composition	SMD 3in1 RGB	SMD 3in1 RGB	SMD 3in1 RGB	SMD 3in1 RGB	SMD 3in1 RGB
Life Span	50 000 h	50 000 h	50 000 h	50 000 h	50 000 h

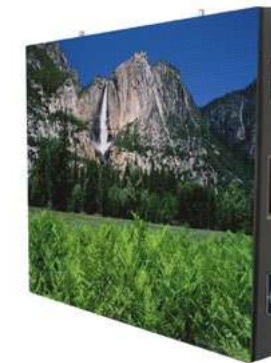
LED Display Cabinet
Fix INDOOR Ver 2.0

SKU: 638 P3 Size
 SKU: 639 P4 Size
 SKU: 640 P5 Size



DC 5V



150°



IP20

	P3	P4	P5
Pixel pitch	3 mm	4 mm	5 mm
Display size	960x960mm	768x768mm	960x960mm
Module size	192x192mm	256x128mm	320x192mm
Brightness	2000cd/m ²	2000cd/m ²	2000cd/m ²
Pixel Density	111 111dots/ m ²	62 500dots/ m ²	40 000dots/ m ²
Drive mode	1/32 Scan	1/16 Scan	1/16 Scan
Refresh rate	1920 Hz	1920 Hz	1920 Hz
Working Temp.	-20°C/+50°C	-20°C/+50°C	-20°C/+50°C
MAX Power	750W	750W	750W
Life Span	50 000 h	50 000 h	50 000 h

LED Displays
Module Indoor

 SKU: 635 P2.5 Size
 SKU: 636 P3.07 Size

	P2.5	P3.07
Pixel pitch	2.5 mm	3.07 mm
Module size	320x160 mm	320x160 mm
Module pixels	192x192 pixel	192x192 pixel
Brightness	650cd/m ²	600cd/m ²
Refresh rate	3840 Hz	3840 Hz
Drive mode	1/32 Scan	1/32 Scan
Module Power	140W	127W
Working Temp.	-20°C/+50°C	-20°C/+50°C
Pixel Composition	SMD 3in1 RGB	SMD 3in1 RGB
Life Span	100 000 h	100 000 h

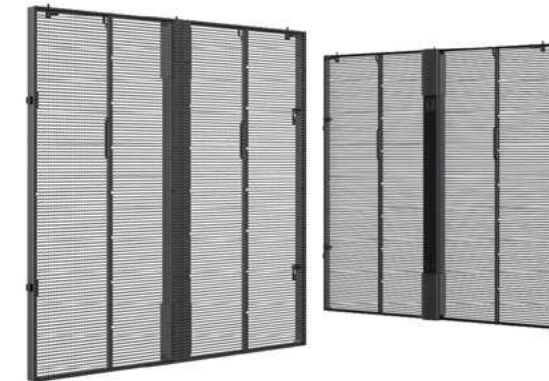
LED Transparent Displays
Module Indoor

SKU: 66020 P3.91 Size



	P3.91
Pixel pitch	Horizontal 3.91mm Vertical 7.82mm
Module size	1000x1000 mm
Drive mode	1/16 Scan
Brightness	2500cd/m ²
Refresh rate	960 Hz
Pixel Density	32768 dot/m ²
Module Power	400W/m ²
Working Temp.	-20°C/+50°C
Pixel Composition	SMD 3in1 RGB
Life Span	50 000 h

LED Display Front Service
Module Indoor

 SKU: 66019 P1.875 Size
 SKU: 66018 P2.5 Size

	P1.875	P2.5
Pixel pitch	1.875 mm	2.5 mm
Module size	480x480 mm	480x480 mm
Module pixels	240x240 pixel	240x240 pixel
Brightness	500-800cd/m ²	500-800cd/m ²
Refresh rate	3840 Hz	3840 Hz
Pixel Density	284 444dots/m ²	160 000dots/m ²
Module Power	500W/m ²	20W
Working Temp.	-20°C/+50°C	-20°C/+50°C
Pixel Composition	SMD 3in1 RGB	SMD 3in1 RGB
Life Span	50 000 h	50 000 h

LED Displays Rental
Module Indoor

SKU: 101 P2.6 Size



	P2.6
Pixel pitch	2.6 mm
Module size	500x500 mm
Module pixels	192x192 pixel
Brightness	2000cd/m ²
Refresh rate	3840 Hz
Drive mode	1/32 Scan
Module Power	650W Max
Working Temp.	-20°C/+50°C
Pixel Composition	SMD 3in1 RGB
Life Span	100 000 h

**LED Display Cabinet
Fix OUTDOOR**

SKU: 617 P4 Size
 SKU: 618 P5 Size
 SKU: 619 P8 Size
 SKU: 607 P10 Size



	P4	P5	P8	P10
Pixel pitch	5 mm	5 mm	8 mm	10 mm
Display size	768x768mm	960x960mm	768x768mm	960x960mm
Module size	256x128mm	160x160mm	256x128mm	160x160mm
Brightness	5500cd/m ²	5500cd/m ²	5500cd/m ²	7500cd/m ²
Pixel Density	62 500dots/ m ²	40 000dots/ m ²	15 625dots/ m ²	40 000dots/ m ²
Drive mode	1/8 Scan	1/8 Scan	1/8 Scan	1/8 Scan
Refresh rate	1920 Hz	1920 Hz	1920 Hz	1920 Hz
Working Temp.	-20°C/+50°C	-20°C/+50°C	-20°C/+50°C	-20°C/+50°C
MAX Power	800W	800W	800W	800W
Life Span	50 000 h	50 000 h	50 000 h	50 000 h

**LED Displays
Rental INDOOR**

SKU: 620 P2.5 Size
 SKU: 613 P4 Size
 SKU: 614 P5 Size



	P2.5	P4	P5
Pixel pitch	2.5 mm	4 mm	5 mm
Display size	640x640mm	768x768mm	960x960mm
Module size	160x160mm	256x128mm	320x160mm
Brightness	2000cd/m ²	2000cd/m ²	2000cd/m ²
Pixel Density	160 000dots/ m ²	62 500dots/ m ²	40 000dots/ m ²
Drive mode	1/16 Scan	1/16 Scan	1/16 Scan
Port Type	HUB75	HUB75	HUB75
Working Temp.	-20°C/+50°C	-20°C/+50°C	-20°C/+50°C
MAX Power	600W	600W	750W
Life Span	50 000 h	50 000 h	50 000 h

P3.91



P5



	P3.91	P5
Pixel pitch	3.91 mm	5 mm
Display size	500x1000mm	960x960mm
Module size	250x250mm	320x160mm
Brightness	6500cd/m ²	7500cd/m ²
Pixel Density	65 532dots/ m ²	40 000dots/ m ²
Drive mode	1/16 Scan	1/8 Scan
Port Type	HUB75	HUB75
Working Temp.	-20°C/+50°C	-20°C/+50°C
MAX Power	800W	750W
Life Span	50 000 h	50 000 h

**LED Displays
Rental OUTDOOR**

SKU: 615 P3.91 Size
 SKU: 616 P5 Size



LED Display Poster
Outdoor

SKU: 66027 P3 Size

SKU: 66025 P3.84 Size



	P3	P3.84
Pixel pitch	3 mm	3.84 mm
Display size	600x1200mm	600x1200mm
Module size	200x200mm	200x200mm
Brightness	>6000cd/m ²	>6000cd/m ²
Pixel Density	102400dots/ m ²	67600dots/ m ²
Drive mode	1/16S	1/13S
Refresh rate	4000 Hz	4000 Hz
Working Temp.	-20°C/+70°C	-20°C/+70°C
MAX Power	950W /m ²	820W /m ²
Life Span	100 000 h	50 000 h

**LED Displays
Rental INDOOR**

SKU: 102 P2.9 Size

SKU: 628 P3.91 Size



	P2.9	P3.91
Pixel pitch	2.9 mm	3.91 mm
Display size	500x500mm	500x500mm
Module size	168x168mm	128x128mm
Brightness	5000cd/m ²	5000cd/m ²
Pixel Density	28224dots/ m ²	62 500dots/ m ²
Drive mode	1/21 Scan	1/21 Scan
Refresh rate	3840 Hz	3840 Hz
Working Temp.	-20°C/+50°C	-20°C/+50°C
MAX Power	650W	650W
Life Span	100 000 h	100 000 h

LED Display Poster
Outdoor Double-sided

SKU: 66028 P3 Size

SKU: 66026 P3.84 Size



	P3	P3.84
Pixel pitch	3 mm	3.84 mm
Display size	600x1200mm	600x1200mm
Module size	200x200mm	200x200mm
Brightness	>6000cd/m ²	>6000cd/m ²
Pixel Density	102400dots/ m ²	67600dots/ m ²
Drive mode	1/16S	1/13S
Refresh rate	4000 Hz	4000 Hz
Working Temp.	-20°C/+70°C	-20°C/+70°C
MAX Power	950W /m ²	820W /m ²
Life Span	100 000 h	50 000 h

**LED Displays
FIX OUTDOOR V2**

SKU: 624 P4 Size

SKU: 623 P8 Size



	P4	P8
Pixel pitch	2.9 mm	3.91 mm
Display size	960x960mm	960x960mm
Module size	321x160mm	320x1620mm
Brightness	6500cd/m ²	6500cd/m ²
Pixel Density	62 500dots/ m ²	62 500dots/ m ²
Drive mode	1/16 Scan	1/16 Scan
Refresh rate	3840 Hz	1920 Hz
Working Temp.	-20°C/+50°C	-30°C/+65°C
MAX Power	600W	600W
Life Span	100 000 h	100 000 h



LED Display Screen OUTDOOR STADIUM

SKU: 622 P10 Size



DC 5V



150°



IP65

	P10
Pixel pitch	10 mm
Module size	320x160mm
Module pixels	32x16 pixel
Brightness	7500cd/m ²
Pixel Density	10 000dots/ m ²
Drive mode	1/4 Scan
Port Type	HUB75
Working Temp.	-20°C/+50°C
MAX Power	700W
Life Span	50 000 h



LED Displays INDOOR Poster Display

SKU: 66024 P2 Size

SKU: 621 P3 Size



DC 5V



150°



IP20

	P2	P3
Pixel pitch	2 mm	3 mm
Module size	256x128 mm	192x192 mm
Module pixels	128x64 pixel	64x64 pixel
Brightness	1100nits/m ²	2000cd/m ²
Pixel Density	250 000dots/ m ²	111 111dots/ m ²
Drive mode	-	1/32 Scan
Port Type	HUB75	HUB75
Working Temp.	-20°C/+50°C	-20°C/+50°C
Pixel Composition	SMD 3in1 RGB	SMD 3in1 RGB
Life Span	100 000 h	100 000 h



LED Display Accessories

Splitter



DIS-300 is specialized for multi-screens and super large led screens. The card possesses two input ports and eight output ports, enabling that one split to eight and two split to four. Functions change automatically. Each RJ45 port can be independently adjusted, and support read back parameters from scan board.

Description:

- 1 in 8 out or 2 in 4 out, automatic switching.
- Each RJ45 port can be independently adjusted.
- No need to install the drivers



SKU: 952



IP20

LED DISPLAYS

43 inch IR touch



CPU: Bay Trail-D Celeron Quad-core J1900 2.0GHZ
 Chipset: Intel Bay trail SOC
 GPU Integrate: Intel HD Graphics
 Display output : VGA, built-in VGA pin, HDMI, HDMI pin, LVDS
 Memory: DDR3 2GB
 Hard drive: 32G Hard drive

SKU: 671 43inch



IP20

**RECEIVING CARDS
 FOR LED DISPLAYS**

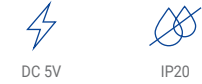
**RECEIVING CARDS
 FOR LED DISPLAYS**

SKU No.	950	652	653	654	655
Resolution	256 x 226	512 x 256	256 x 226	256 x 226	512x256
RGB Data Output	16 Groups	32 Groups	24 Groups	24 Groups	32 Groups
Interface	8 x HUB75	16 x HUB75	8 x HUB75	12 x HUB75	16 x HUB75

SKU No.	112	113	149
Resolution	256 x 226	512 x 384	512x512
RGB Data Output	24 Groups	24 Groups	24 Groups
Interface	12 x HUB75	32 x HUB75	24 x HUB75

**SENDING CARD
 FOR LED DISPLAYS**

SKU No.	650	651
Input Resolution	1280x1024,1024x1200,1600x848	1920x1200,2048x1152,2560x96
Capacity	1.3 million pixels	2.3 million pixels
Supply Voltage	5V	5V
Control Method	USB Interface	USB Interface
Video Interface	DVI	HDMI/DVI
Audio Interface	3.5mm	HDMI/3.5mm
Video Format	RGB	RGB ,YCrCb4:2:2,YCrCb4:4:4
Output Interface	2 Ethernet ports	4 Ethernet ports
Bit Depth	8bit	8/10/12bit

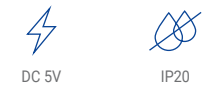
**Multifunctional CARD
 FOR LED DISPLAYS**

MFN300
 Ethernet connection: 2x Gigabit Ethernet connection
 RS232: Sub-D 9-pin connector
 Audio: 3.5mm
 Supply voltage: DC 5V
 Operating temperature: -20 ~ 75°C
 Dimensions: 144 x 92 x 20mm
 Weight: 0.165 kg

SKU: 972



Sending Box LED Display Controller

The Optonica Sender card control box is a sending card inside of an enclosure with a built in power supply. You can order the stand alone card if you do not need the enclosure.

Product Type:	Controller
Capacity:	1.3 million pixels
Supply Voltage:	AC-100-240V-50/60HZ
Control Method:	USB Interface
Video Interface:	DVI
Audio Interface:	3.5mm
Viedo Format:	RGB
Output Interface :	2 Ethernet ports
Bit Depth Of Video Resource:	8bit
Light Sensor Interface:	1
USB Cable:	1.5M



SKU: 948



IP20



Sending Box Synchronous LED Display Controller MCTRL700

The MCTRL700 is a video controller for LED screens developed by NovaStar. It supports 1x DVI input, 1x HDMI input, 1x audio input and 6 Ethernet outputs, with a loading capacity of 1920x1200@60Hz. The MCTRL700 is suitable for rental and fixed installations, such as concerts, live shows, monitoring centers, events, sports halls, etc.

Product specification: Product Type Controller
 Inputs: 1xSL-DVI (IN-OUT) 1xHDMI 1.3 (IN-OUT) 1xAUDIO
 Outputs: 6x RJ45, 1x HDMI 1.3, 1x SL-DVI
 Capacity: 650,000 pixels
 Dimensions (w/h/d): 482.6 x 44.4 x 268.50mm
 Weight: 2.6 kg

SKU: 114



IP20



VX600



Video Processor for LED screens LED Display Controller

High-quality and precise video processor used in LED screen installations

Typ: Video Controller

SKU: 150 VX600

Inputs: 2x HDMI 1.3, 1x DVI, 1x 3G-SDI (max. 1920x1080@60Hz)
 Outputs: 6x LED-Out (RJ45) 1x HDMI 1.3 Out, 2x OPT-Out (10G)
 Capacity: 3.9 million pixels

VX1000



SKU: 151 VX1000

Inputs: 2x HDMI 1.4, 1x DVI, 1x 3G-SDI Max. width: 4092 pixels (4092x1136@60Hz)
 Outputs: 10x LED-Out (RJ45) 1x HDMI 1.3 Out, 2x OPT-Out (10G)
 Capacity: 6.5 million pixels with a maximum width of 10,240 pixels and a maximum height of 8192 pixels

Dimensions (w/h/d): 483.6 x 351.2 x 50.1mm
 Weight: 4 kg



IP20



Sending Box Synchronous LED Display Controller

supports extra-large resolution. With HDMI/DVI video input and four Ethernet port outputs, a single unit is able to load 2560x960. Multiple units can be cascaded for uniform control.

Product specification: Product Type Controller
 Input Resolution: 1920x1200,2048x1152,2560x960
 Capacity: 2.3 million pixels
 Supply Voltage: AC-100-240V-50/60HZ
 Control Method: USB Interface
 Video Interface: HDMI / DVI
 Audio Interface: HDMI/3.5mm
 Viedo Format: RGB,YCrCb4:2:2,YCrCb4:4:4
 Output Interface: 4 Ethernet ports
 Bit Depth Of Video Resource: 8/10/12bit
 Light Sensor Interface: 1



SKU: 947



IP20



MCTRL4K LED Screen Controller

The MCTRL 4K is a 4K x 2K controller with a loading capacity of up to 4096x2160@60Hz and supports every resolution in that range. These features make this controller suitable for very large and wide LED displays

Type: Video Controller
 Inputs: 1x DP 1.2, 1x HDMI 2.0, 2x Dual-Link DV
 Outputs: 16x LED output (RJ45), 4x OPT Out (2x Main, 2x Backup)
 Capacity: 8.8 million pixels
 Dimensions (w/h/d): 482.6 x 372 x 89mm
 Weight: 4.6 kg.

SKU: 171



IP20



TB40 CONTROLLER

Multimedia Players

Wi-Fi media player used in the construction of LED screens with 2 Ethernet ports with a capacity of up to 1,300,000 pixels each with a maximum width of 4096 pixels and a maximum height of 4096 pixels.

TB40 enables intelligent control of the LED screen with an application for tablets and smartphones.

- 4 core 1.8 GHz processor
- 1 GB of RAM
- 16 GB of internal storage (4 GB available)
- Dual Wi-Fi modes

SKU: 152



IP20



TB40 CONTROLLER

Multimedia Players

Wi-Fi media player used in the construction of LED screens with 2 Ethernet ports with a capacity of up to 1,300,000 pixels each with a maximum width of 4096 pixels and a maximum height of 4096 pixels.

TB40 enables intelligent control of the LED screen with an application for tablets and smartphones.

- 4 core 1.8 GHz processor
- 1 GB of RAM
- 16 GB of internal storage (4 GB available)
- Dual Wi-Fi modes

SKU: 153



IP20



TB1 CONTROLLER

Multimedia Players

Wi-Fi media player used in the construction of LED screens with a capacity of up to 650,000 pixels with a maximum width of 1920 pixels and a maximum height of 1080 pixels. TB1 enables intelligent control of the LED screen with an application for tablets and smartphones.

- 4 core 1.5 GHz processor
- 1 GB of RAM
- 8 GB of internal storage (4 GB available)

SKU: 115



IP20

**NEW
PRODUCT**

TB2 CONTROLLER

Multimedia Players

Wi-Fi media player used in the construction of LED screens with a capacity of up to 650,000 pixels with a maximum width of 1920 pixels and a maximum height of 1080 pixels. TB2 enables intelligent control of the LED screen with an application for tablets and smartphones.

- 4 core 1.5 GHz processor
- 1 GB of RAM
- 8 GB of internal storage (4 GB available)



IP20

SKU: 116

**NEW
PRODUCT**

TB4 CONTROLLER

Multimedia Players

Wi-Fi media player used in the construction of LED screens with 2 Ethernet ports with a capacity of up to 1,300,000 pixels each with a maximum width of 4096 pixels and a maximum height of 1920 pixels.

TB4 enables intelligent control of the LED screen with an application for tablets and smartphones.

- 8 core 1.5 GHz processor
- Hardware decoding and playback of H.265 4K HD videos
- Hardware decoding of 1080P videos
- 2 GB of RAM
- 8 GB of internal storage (4 GB available)
- Dual Wi-Fi modes



IP20

SKU: 117



TB6 CONTROLLER

Multimedia Players

- Loading capacity up to 1,300,000 pixels, with the maximum width of 4096 pixels and maximum height of 1920 pixels
- Wired Gigabit Ethernet
- Stereo audio output
- HDMI Loop
- HDMI input and auto full-screen display
- 2 USB ports allowing for USB playback
- Onboard light sensor connector allowing for automatic and scheduled brightness adjustment
- Synchronization mechanism for multi-screen playing
- Powerful processing capability
- Comprehensive control plans
- Synchronous and asynchronous dual-mode
- Dual-Wi-Fi mode
- Redundant backup



IP20

SKU: 661



TB8 CONTROLLER

Multimedia Player

- 4 Ethernet ports, loading capacity of each port up to 2,300,000 pixels, with the maximum width of 4096 pixels and maximum height of 1920 pixels
- Wired Gigabit Ethernet
- Stereo audio output
- HDMI Loop
- HDMI input and auto full-screen display
- 2 USB ports allowing for USB playback
- Onboard light sensor connector allowing for automatic and scheduled brightness adjustment synchronization mechanism for multi-screen playing
- Powerful processing capability
- Comprehensive control plans
- Synchronous and asynchronous dual-mode
- Dual-Wi-Fi mode



IP20

SKU: 946



ALL-IN-1 CONTROLLER

LED VIDEO PROCESSOR WITH SDI



Product Type :	Video Controller
Inputs :	HDMI, DVI, VGA × 2, CVBS × 2, DP, SDI
Outputs :	Ethernet port × 4
Loading Capacity :	2.35 million pixels
Maximum pixel CLK :	165MHz
Video Loop :	DVI LOOP, SDI LOOP
Video Monitor :	VGA OUT, DVI OUT
Communication Mode:	USB/LAN
Image Mosaic :	Support
Crop Settings :	Support
PIP :	Support



SKU: 656



IP20

4G Module

for LED Multimedia Players



4G module can be used for all Optonica multimedia players. The 4G module, combined with external Sim card, enables you to access you're Optonica multi media player even when there is no Wi-Fi or LAN network available by using the 4G network. The compact module is plug and play, no further drivers are required.

- 4G module
- Access media player anywhere anytime
- Antenna included



SKU: 949



IP20

Power Supplies

Metal 5V output



Watts	200W	300W
Input Voltage	220V	220V
Output Voltage	DC:5V	DC:5V
Current	40A	60A
Material	Metal	Metal
Dimension	190x80x30mm	190x80x30mm

SKU: 6191 200W 3800156661912

SKU: 6192 300W 3800156661929



DC 5V



IP20

Light Sensor

for Brightness Adjustment



Accessory light probe with the following features:

- Monitor the brightness of the environment to achieve automatic adjustment of screen brightness.
- Connect the sending card and sending box, asynchronous card or multi-function card.
- Marking the 5 meter line, can be extended to 100 meters;
- In the outdoor use, three defense;
- No external power supply is required.

SKU: 951



IP20

Accessories



18*10W Flat aluminium RGBW LED PAR Light

Voltage: AC90-260V 50/60Hz
 Power: 180W
 Light source: 18*10W RGBW led par light
 LED life: 50,000 hours.
 Lens degree: 15° 25°, 45° (optional)
 DMX channel :4/8CH
 Control Mode: Auto, Sound, DMX512, Master-slave
 Strobe: 0 ~ 20 times / sec.

SKU: 683



RGB+W



IP20

7*10w Mini RGBW LED PAR Light

Voltage: AC100~240V 50~60Hz
 Power consumption: 70W
 Light source: 7*10W RGBW 4in1 LED
 Beam angle: 15° 25° 40° optional
 DMX channels: 7 CHS
 Function: DMX AutoSound Master-slave, strobe, dimmer
 Housing Material : plastic
 Working Environment: -20~40
 Packing size: 22.5*10*22.5Cm (1pc/CTN)

SKU: 691



RGB+W



IP20

18*10W Flat aluminium RGB LED PAR Light

Voltage: AC90-260V 50/60Hz
 Power:180W
 Light source: 18x 10W 4 in 1 LED
 LED life: 50,000 hours.
 Lens degree: 15° 25°, 45° (optional)
 DMX channel :4/8CH
 Control Mode: Auto, Sound, DMX512, Master-slave
 Strobe: 0 ~ 20 times / sec.

SKU: 943



RGB



IP20

7*10w Remote Mini RGB+WW LED PAR Light

Voltage: AC100~240V 50~60Hz
 Power consumption 70W
 Light source: 7*10W RGB+WW 4in1 LED
 Beam angle: 25° optional
 DMX channels: 4/6CH
 Function: DMX, Remote, Auto, Sound, Master-slave, Strobe, Dimmer
 Housing Material : Plastic
 Protection power :IEC power in and out Working Environment: -20~40
 Packing size: 22.5*10*22.5Cm (1pc/CTN)

SKU: 692



RGB+WW



IP20

LED Slim Flat PAR Can 18x18W RGBWA+UV 6 in 1

Voltage: AC90-245V, 50-60HZ
 Power: 180W
 Light source: 18x 18W RGBWA+UV 6 in 1 LED
 LED life: 50,000 hours.
 Lens degree: 15° 25°, 45° (optional)
 DMX channel: 10/6CH
 Control Mode: Auto, Sound, DMX512, Master-slave Function
 effect: dimmer /Strobe /Eotic /Gradual change
 Strobe: 0 ~ 20 times / sec.

Size: 265x80x280 mm
 Net weight 3kg

SKU: 177



RGBWA+UV



IP20

36*3W LED PAR Light

Voltage: AC100-260V 50Hz/60Hz
 Consumption: 50W/120W
 Lamp: 3W*36* LED lamp R12G12B12
 Channel: 7CH
 Mode of control: DMX512, automatic, voice active.
 Function: Can make magic, color mixed, charming effect
 Packing size: 290*290*410mm

SKU: 690



RGB



IP20

Laser RGB5000



Voltage: AC90-240V, 50/60HZ
 Consumption: 120W
 Scanner: 25kfps
 Laser power:
 1x1000mW Red 638nm,
 1x1000mW Green 520nm,
 1X3000mW Blue 450nm
 Colors: RGB full color
 Control signal: DMX-512
 Control mode: music, auto, master-slave and DMX-512, ILDA control
 DMX channel: 10/34ch
 Size: 270x200x160 mm
 Weight: 5.5 kg

SKU: 166



IP20



3pcs *60W warm white + 36 *3W RGB

Input voltage: 100-240Vac/50-60Hz
 Product power: 250W
 Light source: 3pcs *60W warm white + 36 *3W RGB
 Channel: 14CH/22CH
 Control mode: DMX512, master/slave,
 self-propelled, voice control
 Dimming method: 0-100% ultra-smooth dimming
 Strobe: 25 times/sec

SKU: 128



RGB



IP20

Laser RGB3000



Voltage: AC90-240V, 50/60HZ
 Consumption: 120W
 Scanner: 25kfps
 Laser power:
 1x500mW Red 638nm,
 1x800mW Green 520nm,
 1X1700mW Blue 450nm
 Colors: RGB full color
 Control signal: DMX-512
 Control mode: music, auto, master-slave and DMX-512, ILDA control
 DMX channel: 10/34ch
 Size: 270x200x160 mm
 Weight: 5.5 kg

SKU: 165



IP20



WATERPFOOR RGBW 4in1 Flat Par 18

Voltage: AC100-240V
 Frequency: 50Hz-60Hz
 Consumption: 180W
 Lamp: 18pcs10W RGBW 4in1 LED
 Channel: 8/4CH
 IP rate: IP65
 Mode of control: DMX512, Auto, Sound, Master-slave.
 Function: Can make magic, color mixed, charming effect
 Net weight: 3.7KG

SKU: 129



RGB+W



IP20

Laser RGB1000



Voltage: AC90-240V, 50/60HZ
 Consumption: 120W
 Scanner: 20kfps
 Laser power:
 1x170mW Red 638nm,
 1x100mW Green 520nm,
 1X700mW Blue 445nm,
 Colors: RGB full color
 Control signal: DMX-512
 Control mode: music, auto, master-slave and DMX-512, ILDA control
 DMX channel: 10/34ch
 Size: 270x200x160 mm
 Weight: 5.5 kg

SKU: 164



IP20



7x100W Waterproof White Halogen Lamps

Work voltage: 220V/50-60Hz
 Light source: 7x100W Halogen lamps (philips)
 Power consumption: 700 W
 Color temperature: 1650K-6500k
 Control mode: Auto-run , Master-Slave , DMX control
 DMX channel: 1CH/6CH /7CH
 DMX connector: 3+5 pin XLR connector (selected)
 Display: Color LCD display
 Installation Tripod stand /Hang on /Base
 Reflector bowl color: Silver
 Size: 456*520*130 mm
 Weight: 7.65KG

SKU: 967



IP65



Battery

7x12W Waterproof RGB 6IN1 LED PAR Light Battery - Wireless

Waterproof 7x12W RGB 6IN1 Battery Wireless Led Par
 Light source: 7pcs 15w LED 4in1 mixing color
 Beam Angle: 25°
 Dimmer: 0-100% dimmer
 Strobe rate:0-24HZ
 Working Environment: -20-40
 DMX Channels: 2 DMX modes, 4channels mode & 8 channels mode
 Control Mode: DMX512,Master-slave,Sound,Auto,Wireless,remote.
 Battery type: Lithium Ion
 Battery Charge Time: 3hours(full power)
 Battery Life: 3.5(all on) hours,14 (single Color) hours
 Battery Power: 24V, 5Ah
 Wireless effective distance: 400meters

SKU: 940



RGB



IP54



Waterproof 44x10w RGBW 4in1 Led wall light

Power Supply: AC 90-240V/50-60Hz
 Power consumption: 450W
 Light source: 44pcsx10W RGBW Led
 Beam Angel: 25-35°
 Dimmer: 0-100% dimmer
 IP rate: IP67,outdoor
 Control Mode: RDM, DMX512 Control, Sweden Import wireless DMX

SKU: 66127



RGB+W



IP67



Battery

7x8W Waterproof RGB 6IN1 LED PAR Light Battery - Wireless

Light source: 7pcs 8w LED 4in1 mixing color
 Beam Angle: 25°
 Dimmer: 0-100% dimmer
 Strobe rate:0-24HZ
 Working Environment: -20-40
 DMX Channels: 2 DMX modes, 4channels mode & 8 channels mode
 Control Mode: DMX512,Master-slave,Sound,Auto,Wireless,remote.
 Battery type: Lithium Ion
 Battery Charge Time: 3hours(full power)
 Battery Life: 3.5(all on) hours,14 (single Color) hours
 Battery Power: 24V, 5Ah
 Wireless effective distance: 400meters

SKU: 941



RGB



IP54



Battery

9*10W Wifi control Waterproof RGBA+UV 6 in 1

Power Supply: AC 100-240V/50-60Hz
 Power consumption: 90W
 Light source: 9pcs LED RGBWA+UV 6in1 mixing color
 Beam Angel: 15°
 Dimmer: 0-100% dimmer
 Strobe rate:0-24HZ
 Working Environment: -20-40
 DMX Channels: 2 DMX modes, 6channels mode & 10 channels mode
 Control Mode: DMX512,Master-slave,Sound,Auto,Wireless,remote, wifi
 Battery type: Lithium Ion
 Battery Charge Time: 6 hours
 Battery Life: (all on) 4 hours, (single Color) 24hours
 Battery Power: 12V, 25Ah

SKU: 932



RGB+UV



IP54



12x10W Waterproof RGBWA+UV 6IN1 LED PAR Light

Voltage: AC100-240V 50Hz-60Hz
 Consumption: 150W
 LED: 12pcs 10W RGBWA+UV 6 in1 LED
 Channel: 6CH/9CH
 Mode of control: DMX512, Auto, Master-slave
 Function: Can make magic, color mixed, charming effect

SKU: 945



RGB-WA



IP65



Battery

24X3W RGB 3IN1 LED Wall Washer Battery - Wireless

Power Supply: AC 100-240V/50-60Hz
 Power consumption:80W
 Light source: 24pcs*3w LED RGB 3in1 mixing color
 Beam Angle: 10/20/25 degree
 Dimmer: 0-100% dimmer
 Strobe rate:0-24HZ
 Control Mode: DMX512,Master-slave,Sound,Auto, remote
 Build-in more than 9 build-in programs
 Generate endless effects with built-in, automated programs
 Product size: 1030x62x58mm

SKU: 936



RGB+W



IP20

Pixel control 18*10w RGBW 4in1 LED Wallwasher



Voltage: AC90V-245V/50-60Hz
 Power: 200W Light source
 Pixel control: 18*10w RGBW 4in1 LED wash
 Beam angle: 15° or 40° Rate :use indoor only
 Leds: 18pcs 10W RGBW 4IN1 LEDS
 Life time: >100 thousand hours
 Color: RGBW Wcolor can be mixed to more than 16.7million kinds of color
 Function effect: dimmer, strobe, eotic, gradual change

SKU: 993



Compact Pinspot LED 40W RGBW 4in1 Par with manual zoom

Power Supply: AC 100-240V/50-60Hz
 Power consumption: 40W
 Light source: 40 W RGBW 4in1 LED
 Beam Angle: 40°
 Zoom range: 4~60° manual zoom
 Dimmer: 0-100% dimmer
 Strobe rate: 0-20HZ
 Working Environment: -20-40
 IP rate: IP20,indoor
 DMX Channels: 6ch
 Control Mode: DMX512,Master-slave,Sound,Auto, Remote
 Net weight: 2kg

SKU: 990



5 Head Matrix Blinder



Voltage: AC100-240V 50/60Hz
 Power: 60W
 Light source: 5PCS 10W CREE RGB 3in1 LED
 Function: Color mix, automatic color change, built-in program and strobe effect with adjustable speed, dimmer, master/slave
 Light size: 620*130*160mm
 Weight: 4kg

SKU: 992



1000W LED Strobe RGB

Voltage: AC110-240V, 50/60HZ
 Consumption: 1000W
 Light source: 800pcs 1.2w SMD RGB LEDs
 Channel: 1CH /3CH/6CH
 IP rate: IP20
 Display Panel: LED Blue Display
 Housing material: Black Aluminum shell
 Mode of control: DMX512,Master-slave,Sound,Auto
 Dimension: 510*220*305mm
 Weight: 5.7kgs

SKU: 995



LED COB Blinder 2X100 W



LED: 2pcs*100W COB LED
 Light Color: Single color WW(100W)
 LED light time: over 50000 hours
 Voltage: AC 100V-240V 50-60Hz
 Power consumption: 260W
 Beam angle: 30 degree
 Dimmer: 0-100% linear adjustable
 Strobe: Variable speed (1-30Hz)
 Refresh rate: 11700Hz , 100% flicker free for film and TV camera
 Color effect feature: with individual control effect
 Power input: powercorn connector
 Housing material: Metal
 Control mode: DMX512,Master/Slave,Auto,Sound alone,Sound active
 DMX Channel: 2/5 CH

SKU: 994



Battery Mini 4 *10W RGBWA+UV 6in1 LED PAR

Power Supply: AC 100-240V/50-60Hz
 Power consumption: 40W
 Light source: 4pcs 10W LED RGBWA+UV 6in1 mixing color
 Beam Angle: 15°
 Dimmer: 0-100% dimmer
 Strobe rate: 0-24HZ
 Working Environment: -20-40
 IP rate: IP20,indoor
 DMX Channels: 6CH ,10CH
 Control Mode: DMX512, Master-slave,Sound,Auto, Remote

SKU: 988



4x10W Wifi Control RGB 6IN1 Charging F Case



Battery

Power Supply: AC 100-240V/50-60Hz
 Power consumption: 40W
 Light source: 4pcs LED RGBWA+UV 6in1 mixing color
 Beam Angle: 15°
 Dimmer: 0-100% dimmer
 Strobe rate: 0-24HZ
 DMX Channels: 2 DMX modes, 6channels mode & 10 channels mode
 Control Mode: DMX512, Master-slave, Sound, Auto, Wireless, Wifi, Remote
 Battery type: Lithium Ion
 Battery Charge Time: 3 hours (full power)
 Battery Life: (all on) 6hours, (single Color) 36hours
 Battery Power: 12V, 10Ah
 Wireless effective distance: 400meters
 Product size: 140*140*200mm



RGB+WA



IP20

SKU: 935



Beam Moving Head Double Prism

Voltage: 100-240V 50/60Hz
 Power: 230W
 Channel: 16ch
 Light source: 230W Lamp
 Gobo wheel: 17 metal gobos+white
 Color wheel: 14 colors+white
 8/16prism/24prism optional ,prism rotation
 Lens : 6-layer optic glass lens
 Motor : 2-phase step motors
 Features: moving more smoothly and no shake
 The channel list is same with Clay Paky
 Display : Roller Button screen
 Size: 410x460x510mm



IP20

SKU: 685

9X10W RGB 6IN1 LED PAR Light Charging F Case - Wireless Transmitter



Battery

Power consumption: 90W
 Light source: 9pcs LED RGBWA+UV 6in1 mixing color
 Beam Angle: 15°
 Dimmer: 0-100% dimmer
 Strobe rate: 0-24HZ
 DMX Channels: 2 DMX modes, 6channels mode & 10 channels mode
 Control Mode: DMX512, Master-slave, Sound, Auto, Wireless.
 Battery type: Lithium Ion
 Battery Charge Time: 6 hours
 Battery Life: (all on) 4 hours, (single Color) 24hours
 Battery Power: 12V, 25Ah
 Wireless effective distance: 400meters



RGB+WA



IP20

SKU: 937



Compact Mini Beam 7R Moving Head Light

Voltage: 100-240V 50/60Hz
 Power: 250W
 Channel: 16ch
 Light source: 230W Lamp
 Gobo wheel: 14 metal gobos+white
 Color wheel: 13 colors+white
 8facet prism ,prism rotation
 Lens : 6-layer optic glass lens
 Motor : 2-phase step motors
 Features: moving more smoothly and no shake
 The channel list is same with Clay Paky
 Size: 310x220x440mm



IP20

SKU: 686

6X10 RGB 6in1 Battery LED PAR Light



Battery

Power consumption: 60W
 Light source: 6pcs LED RGBWA+UV 6in1 mixing color
 Beam Angel: 30°
 Dimmer: 0-100% dimmer
 Strobe rate: 0-24HZ
 DMX Channels: 2 DMX modes, 6channels mode & 10 channels mode
 Control Mode: DMX512, Master-slave, Sound, Auto, Wireless.
 Battery type: Lithium Ion
 Battery Charge Time: 4 hours
 Battery Life: (all on) 3.5hours, (single LED) 21hours
 Battery Power: 12V, 15Ah
 Wireless effective distance: 400meters



RGB+WA



IP20

SKU: 938



Beam Moving Head 330 15R

Power Supply: AC110v-240V 50/60hz
 Power: 350w
 Light source: 15R 330w lamp
 Ballast: electronic ballast
 Lens: 6-Layer option glass lens
 Beam angle parallel beam angel : 0-3.8°
 Channel: 16ch
 Color temperature: 8000K
 Prism: prism 1: Floral prism rotation, prism 2: 8 Prism rotation
 Gobo: 13 gobos+blank double rotation rainbow effect
 Colors 13 color+blank, single rotation rainbow effect
 Focus: option focus
 Mode of control: DMX512/Master-slave/Stand-alone /Auto mode
 Pan: 540degree (16bit) Electric correction
 Tilt: 270degree (16bit) Electric correction



IP20

SKU: 687

NEW PRODUCT



60W LED Spot Moving Head +12x0.2W RGB

Input Voltage: AC100V-240V,50-60HZ
 Total power: 100W
 Light source: 1x60W white lamp bead, 12 RGB 0.2W lamp bead
 Pattern: 7 patterns + white light
 Color: 7 colors + white light
 Channel: 10/12CH
 Control mode: Voice control, master - slave, self - walk, DMX
 Level: X axis: 540° Y axis: 270°

SKU: 66122



RGB



IP20



NEW PRODUCT



37x15w RGBW 4in1 Moving Head

Input Voltage: AC100V-240V,50-60HZ , rated power 600W
 Light source: 37 15W high brightness quad-bead, light source life: 50000 hours on average
 Zoom Angle: 5-60°
 Stroboscopic flashing: 1-25 times/second
 Control signal: DMX512, master/slave, voice control or self - program
 Control channel: 20/60 two DMX channel modes
 Applicable environment: indoor
 Color: red, green, blue and white in one
 Level: 540 degrees +16bit fine tuning;
 Vertical: 270 degrees +16bit fine tuning
 Product size: 386 mm*423 mm*263 mm

SKU: 66126



RGB



IP20

NEW PRODUCT



400W BSW 3in1 moving head with CMY and CTO

Input Voltage: AC100V-240V,50-60HZ Power Consumption: 430W
 Color temperature: 8000K
 Light source specification: SSL350W Lumen illuminance: 4 meters 80,000 lm
 Focusing system: linear adjustment from 4 meters to 50 meters
 Atomization system: 1 independent atomization effect, soft and natural light spot
 High-speed strobe: 0-30 times/sec. Adjustable speed strobe effect.
 Color: 12 colors + white light. Color half-color function
 Color system: independent CMY+CTO color mixing system
 Fixed patterns: 12 fixed patterns + white light
 Prism system: standard single 6-row prism and 8 + 8 prism, each prism can be independently forward and reverse
 Product size: 380*270*650 mm

SKU: 66125



IP20

NEW PRODUCT



37x15w RGBW 4in1 Moving Head

Input Voltage: AC100V-240V,50-60HZ , rated power 600W
 Light source: 37 15W high brightness quad-bead, light source life: 50000 hours on average
 Zoom Angle: 5-60°
 Stroboscopic flashing: 1-25 times/second
 Control signal: DMX512, master/slave, voice control or self - program
 Control channel: 20/60 two DMX channel modes
 Applicable environment: indoor
 Color: red, green, blue and white in one
 Level: 540 degrees +16bit fine tuning;
 Vertical: 270 degrees +16bit fine tuning
 Product size: 386 mm*423 mm*263 mm

SKU: 66123



RGB+W



IP20

NEW PRODUCT



5x60w Pixel Beam Wash Strobe Bar Led Moving Head

Input Voltage: AC100V-240V,50-60HZ Power Consumption: 500W
 Light Source: Front: Original Osram 5x 60W RGBW 4in1 LED;
 Back: 42x 3W White LED + 84x 0.3W RGB 3in1 LED
 LED Control Feature: Front: 5pcs RGBW LED each Pixel control; Back: 14 sections pixel control, each section 9pcs led.
 Control mode: DMX512, Sound, Master/Slave, Auto run & Sound active
 Channel: 24CH/29CH/105CH - Zoom: 3.8° - 50°
 Pan/Tilt movement: 360 degree infinite rotating
 Power connector: Powercon in/out
 DMX connector: 3-pin XLR in/out
 Effect: Beam , Wash , Strobe Multiple Effect, Pan Tilt infinite rotating

SKU: 66124



RGB+W



IP20



120w Moving Head

Working voltage: AC95V-245V/50Hz
 Product power: 120W
 Pattern parameters: 10 patterns, 8 colors 4. Lamp bead parameters: 1 100W white light bead
 Control mode: international general DMX512, 10 channels
 Working mode: DMX512, master/slave, self-propelled, voice control
 Dimming mode: 0~100% ultra-smooth dimming
 Strobe: 20 times/second
 Opening size: 22cm deep 8cm

SKU: 977



IP20

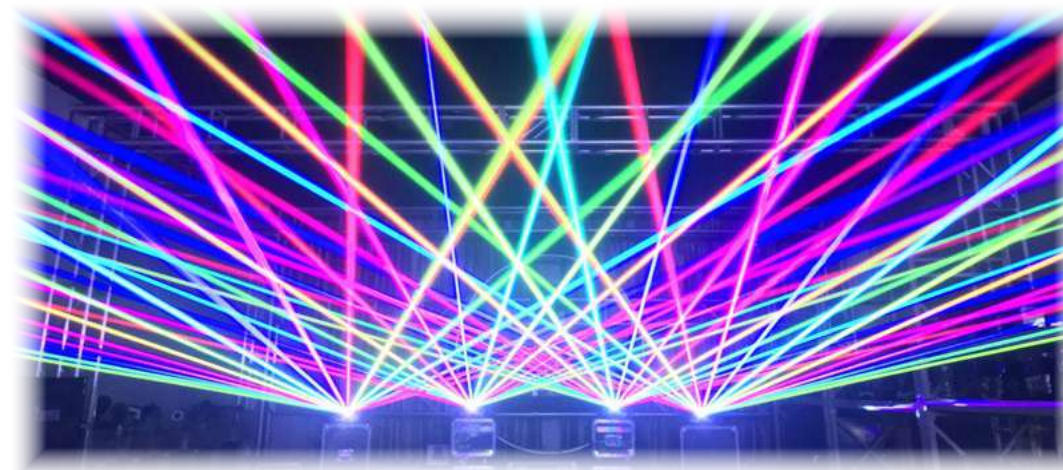

120W Three Prism Wash Gobo 2in1 Moving Head

Working voltage: AC95V-245V/50Hz
 Total product power: 140W
 Pattern parameters: 8 patterns, 8 colors 4. Lamp parameters: 1 80W white lamp, 6 5050 8W RGBW lamp beads
 Control mode: international general DMX512, 15 channels
 Working mode: DMX512, master/slave, self-propelled, voice control
 Dimming mode: 0~100% ultra-smooth dimming
 Strobe: 20 times/second
 Opening size: 22cm deep 8cm

SKU: 974



RGB+W

IP20



4 LED Wash Moving Head

Working voltage: AC95V-245V/50Hz
 Power sumption:100W
 Control mode: DMX512,auto,sound,master-slave
 Channel: 15/10CH
 Dimmer: 0-100% super dimmer
 Strobe: 25 times per second

SKU: 976



IP20



100W Small Steel Cannon Moving Head

Working voltage: AC95V-245V/50Hz
 Product power: 100W
 Pattern parameters: 10 patterns, 8 colors 4. Lamp bead parameters: 1 80W white light bead
 Control mode: international general DMX512, 10 channels
 Working mode: DMX512, master/slave, self-propelled, voice control
 Dimming mode: 0~100% ultra-smooth dimming
 Strobe: 20 times/second
 Opening size: 22cm deep 8cm

SKU: 975



IP20



Mini Beam 100W

Power: 150W
 Light source: 1pc 100W LED White color
 Working lifetime: About 50000 hours
 Working temperature: -20-40
 Control mode: DMX 512, Auto, Master-slave, sound
 Power Socket: Powercon In/Out
 DMX socket: 3pin DMX In/Out
 Prism: 8 prisms
 Color wheel: 7colors+white
 Gobo wheel: 7gobos+white
 Size: 330x280x260mm

SKU: 973



IP20



60W RGBW LED 5050 SMD 3in1 MINI Moving Head

Input Voltage: AC100V-240V,50-60HZ
 Power Consumption: 60W
 Light Source: 60W RGBW LED with 5050 SMD 3in1 MINI moving
 Control mode: DMX512,Sound, Master/Slave, Auto run&Sound active
 Channel: 16/21 CH
 Beam Angle: 8°
 Product Size:160/150/230cm



SKU: 965



Remote control LED 30W spot moving head

Voltage: AC100-240V, 50/60HZ 60W
 Light Source: 1pc*30W White Lamp Bead
 Laser: Green 80mW
 Control Channel: 9/11CH
 Control Mode: Auto,DMX512,Master-slave,Sound
 Pan/Tilt": 540 degrees / 270 degrees



SKU: 123



6x10W Bee Eyes Shaking Head + Laser

Voltage: AC100-240V 50/60 HZ
 Total power: 120W
 Light source 1: 6 Cree+ 10W four-in-one (RGBW) lamp beads
 Light source 2: 1 515nm green laser
 Channel: 15CH
 Control mode: DMX512, master-slave, self-propelled, voice control
 X-axis: 540°
 Y-axis: 180°



SKU: 966



260 9R Beam Moving Head

Voltage: AC90-260V 50/60hz Power: 450W
 Source: YODN MSD 260W 9R,
 Average Lamp Life: 2000H Lumen Output: 10400LM
 Color Wheel: 14 color + white, halftone effect adjustment
 Gobo Wheel: 11 patterns + white
 Prisms: 8prism + Honeycomb prism (2 prisms can be superimposed to 40, can be two-way independent rotation)
 Pan: 540°(16bit accuracy) Tilt: 270°(16bit accuracy)
 Motors: 14 super mute motors, XY three-phase motor
 Frost/Atomization: independent frost effect, spot soft and natural
 Channel: 16/20CHs
 Size: 320*220*580mm (LWH)
 Net Weight: 14.8kg



SKU: 124



MINI 7x12W LED RGBW Moving Head

Input Voltage: AC100-240V/50-60Hz
 Power consumption: 95W
 Light Source: 7pcs 12W LEDs RGBW
 DMX channel: 10CH/15CH
 Control mode: DMX512,auto-run,sound-control,master-slave
 Movement: Pan:540°Tilt:190°
 Display: LED Display
 Housing: LCP+Aluminium Alloy
 Weight: 4.5kg
 Dimension: 160*150*300 mm



SKU: 964



150W LED Beam Spot Wash 3in1 Moving Head

Voltage: AC100-240V,50/60Hz Power: 280W
 Led source: 150W White LED
 Led Life Time: 50000 Hours
 Channel: 18 DMX channel
 Pan: 540 degree + fine ; Tilt: 270 degree + fine
 Zoom range: 8-17°
 Strobe: 1-25 Hz with pulse effect
 Color Wheel: 9 colors + open, with rainbow effect
 Static Gobo Wheel: 10 gobos
 Rotation gobo wheel: 6 gobos+open
 Prism: 3 facet prism with bi-direction rotating
 Frost: With frost effect
 Display: LCD display, can adjust 180 degree to fit
 Product size: 275*200*475mm
 Net Weight: 9kg



SKU: 125



250W LED BSW Moving Head Light

Input Voltage: AC90-260V 50/60Hz
 Power Consumption: 350W
 Light Source: 250W High Output White LED
 Control Signal: DMX 512, master-slave and sound activated or auto operation
 Control Channel: 16/18 DMX Channels USITT DMX-512
 Prism: 8-facet Prism, bi-directional rotatable at variable speeds
 Dimensions: 320*220*480mm
 Weight: 13.50kg

SKU: 981



Light



IP20



60W LED Spot Moving Head Light

Voltage: 100-240V 50/60Hz
 Power consumption: 80 W
 Color: 8 colors
 Gobo: 8 gobos
 Channel: 9/11 ch
 Light source: 1PCS 60W high power White LED
 Control: DMX, Sound, Master-slave, Auto
 Size: 198*144*272 mm
 Net weight: 3.2 kg

SKU: 689



Light



IP20



80W LED Zoom Beam Moving Head

Input voltage: 110-260 V, 50/60 Hz Power: 150W
 Light source: 80W LED
 Working lifetime: About 50000 hours
 Control mode: DMX 512, Auto, Master-slave, Sound
 Channel: 16ch /20ch
 2DMX Modes: STD (16ch)/EXT (20ch)
 Prism: 8 linear prism rotating ,16 linear prism rotating
 Color Wheel: 13 colors+white
 Gobo Wheel: 11 gobos+white,gobo-flow effect,gobo shake
 Function: Dyeing, strobe, zoom, light beam effect
 Pan: 540° (16bit) Tilt: 270° (16bit)
 DMX socket: 3-pin IN/OUT
 Power socket: Power Con IN
 Dimensions: 460*250*290mm

SKU: 982



Light



IP20



10W LED Moving Head Spot

Input power: AC100-240V 50/60Hz
 Power consumption: 22W
 Output LUX: 1500 LUX at 3 meters
 LED: 1 PCS 10W high power white Cree LED
 DMX Channel: 9/11 channels
 Pan:X axis 540 degree ; Tilt:Y axis 270 degree
 Control mode: DMX512/Master-slave/Auto/Sound
 Display: LCD display
 Color wheel: 7 color+open
 Gobo Wheel: 7 gobo+open, gobo-flow effect,gobo shake
 Feature: 8 internal program, sound mode can control by DMX512
 Beam angle: 13 degree
 Net weight: 2.5kg
 Size: 140*160*290 cm

SKU: 984



Light



IP20



36*18W RGBWA+UV LED Moving Head+Zoom Light

Input Voltage: AC90-260V 50/60Hz
 LED: 36 *18W 6in1 RGBWA+UV LED moving
 Power Consumption: 650W
 Control Channel: 18/15 DMX channels
 Control Signal: DMX512, master-slave and sound activated or auto operation
 Power connection: Powercon In DMX data In/
 Out: XLR 3pin(XLR 5pin is optional)
 Packing Dimensions: 450*320*430mm
 Weight: 9 kg

SKU: 983



Light



IP20



6pcs LED Moving Head

Voltage: AC100V~240V/50~60Hz
 Machine power: 120W
 Lamp beads: 15W, RGBW four-in-one LED lamp beads
 Lamp life: more than 50,000 hours
 Lens: Lens Aspheric lens Supports DMX signal priority recognition, signal retention when DMX signal is interrupted
 Beam angle: 1.5°
 Spot angle: minimum 6°, maximum 51°
 Color Rotation System: Color Rotation System: RGBW 4-in-1 Rotation, Macro Function Color System
 Strobe: 1-30 times / sec electronic strobe and random strobe
 Scanning system: horizontal 540° / 1.5 seconds, vertical 180° / 0.5 seconds

SKU: 986



Light



IP20



200W LED Spot Moving Head

Input Voltage: AC100-240V 50/60Hz
 Power: 200W
 Light Source: 1 LED (white) 200 W,
 Beam Angle: 16°
 Colors: 7 + white, split colors, continuous scroll at variable speeds
 Rotation wheel (1): 6 + open (5 aluminum + 1 glass), rotating,
 interchangeable, slot-n-lock, continuous scroll at variable speeds
 Static wheel (2): 8 + open (8 stamped), continuous scroll at variable speeds
 Prism: 3-facet round, bidirectional rotation at variable speeds
 Strobe Rate: 0 to 15 Hz
 DMX Channels: 10 or 16
 Control mode : DMX 512, master-slave , sound , Auto
 DMX connector : 3-pin XLR connectors IN/OUT
 Dimension: 290x194x432mm



SKU: 681 3800156606814

Light

IP20



90W LED Spot Moving Head Light

Voltage: 100-240V 50/60Hz
 Power: 120v 60Hz 148W(0.1A)max,2A inrush
 Beam angle: 14degrees
 Channel: 14ch
 Light source: 1PCS 90W high power White LEDs
 Life rated: more than 50,000hrs
 Size: 250*255*360mm
 Net weight: 6kg
 Carton size: 370*360*340mm



SKU: 985

Light

IP20



120W LED Spot Pattern Moving Head

Input Voltage: AC100-240V 50/60Hz
 Power: 120W
 Light Source: 1 LED (white) 120 W,
 Beam Angle: 16°
 Colors: 7 + white, split colors, continuous scroll at variable speeds
 Rotation wheel (1): 6 + open (5 aluminum + 1 glass), rotating,
 interchangeable, slot-n-lock, continuous scroll at variable speeds
 Static wheel (2): 8 + open (8 stamped), continuous scroll at variable speeds
 Prism: 3-facet round, bidirectional rotation at variable speeds
 Strobe Rate: 0 to 15 Hz
 Control mode : DMX 512, master-slave , sound , Auto
 Cooling : Efficient low noise fan cooling system
 DMX connector : 3-pin XLR connectors IN/OUT



SKU: 684 3800156606845

Light

IP20



7x40w LED Wash Moving Head RGBW Mixing Color

Input: 110-240 V, 50/60 Hz
 Power: 320W
 Light source: 7* 40W RGBW 4in1 mixing color LED wash moving head
 Control mode:DMX512,Auto,Master-slave,Sound
 Channel:17ch/12ch
 2DMX Modes:STD(17ch)/HSI(12ch)
 Function:the dyeing effect,stroke,zoom, the beam light effect
 Pan:540°(16bit)Electric correction
 Tilt:270°(16bit)Electric correction
 Zoom range:9°~ 50°
 Dimmer:0-100% dimmer
 Size:240x300x405mm



SKU: 682

RGBW

IP20



300W LED Moving Head

LED source: 300W LED ; 8000K white LED,16*10W RGBW
 Working Time (hours): 50000
 Fixed gobo wheel: 8 fixed gobos + open and bi-direction rotation
 Color Temperature(CCT): 6000K (Daylight Alert)
 Pan X: 540 degree, Tilt Y: 270 degree
 Channel: 25ch/18ch Dimmer from 0-100%, Strobe
 Beam angle: 3 degree 1 rotate gobo wheel (7 gobos + open) and 1 fixed
 gobo wheel (8 gobos + open)
 1 Color wheel: 7 main colors + open with rainbow effect 2 Prism disk,
 Rotation prism,
 Focus Temperature protect function powercon in & out, color screen,
 Silent fan, good housing Pan/Tilt 0-255 speed controllable



SKU: 126

Light

IP20



12x10w LED Moving Head RGBW

Voltage: AC 110-240V 50/60 Hz
 Power: 150W
 LED QTY: 12*10W RGBW 4in1 LED Moving Head Light
 Lumens: 4500+, Lux @2m 40500+
 Control: Master-Slave / Auto / Sound / DMX
 Channel control: 15CH
 Dimmer: 0-100%
 Flash: 0-20Hz
 Pan / Tilt: User -selectable Pan / Tilt ranges
 Pan/ Tilt: 540 degrees / 270 degrees
 Fine Turning: 8-16 bit
 Color: Black / White
 Size: 300x245x385mm



SKU: 688

RGBW

IP20



19x15W AURA LED Beam Moving Head Light Zoom RGBW

Input Voltage: AC90-260V 50/60Hz
 Power Consumption: 300W
 Zoom range: 8-28degree. Motor: 3pcs
 Control mode: DMX512, master-slave, Sound, Auto
 Channel: 14/25CHs
 Beam (Primary LED array): provide the main output
 Aura (Secondary background LED array): illuminate the front of the head, provide local diffuse light output and can be set to contrast with the beam output.
 Beam: RGBW color control with color temperature control
 Aura: RGB control ; Dimming: 0-100% smoothly dimmer
 Strobe: 20t/s strobe effect with variable speed and pulse effects
 540° PAN and 270° TILT movement
 Size: 410x320x470mm



SKU: 693



4x12W LED Moving Head Light RGBW

Voltage: AC 100*240v 50/60 hz
 Power Consumption: 60w
 Lighting Source: 4*12w RGB+W
 RGBW color mixing
 DMX Channels: Two DMX channels model , 11 or 18
 Control Mode: Auto, Sound Active, Master/Slave, DMX 512
 Dimming: 0-100%
 Strobe: slow to fast
 Pan: 540 degrees, Tilt: 180 deagrees
 Size: 300x20x240mm



SKU: 933

Power CON IN



SKU: 679 Female



SKU: 960 Male

XLR 3PIN -Male , Female - LH P005A



SKU: 678 Male



SKU: 963 Female

Power CON OUT



SKU: 961 Female



SKU: 962 Male

Hook

 SKU: 698 30mm
 SKU: 699 50mm

Safety Rope



SKU: 697



Spark Firework Machine

Voltage: AC 110-240V 50/60 HZ
 Power: 400W
 Control: DMX, remote control
 Temperature: (-10/+50°C)
 Height: 1-5 m
 Spray direction: erect
 DMX Channel: 2
 NW: 9.5 kg



SKU: 902



Stage Fog Waterproof Spark Machine

Power: 400W
 Control: DMX, Remote control
 Temperature (-10/+50°C)
 Height: 1-4 meter
 Spray direction fall
 DMX Channel: 2
 Machine Size: 200x200x180mm
 NW: 6.5KG



SKU: 903



LPG Fire Machine

Voltage: AC110-240V 50/60HZ
 Power: 250W
 Spary Height: 1-2 meter
 Control: DMX512/Electric Control/remote control
 DMX Channel: 1
 Gas: LPG fire gas bottle
 Machine Size: 420x165x200mm
 NW: 7KG



SKU: 904



Firebolt Fire Machine

Voltage: AC110-240V 50/60HZ
 Power: 250W
 Spary Height: 1-4 meter
 Control: DMX512/remote control
 DMX Channel: 4
 Gas: LPG Gas bottle
 Machine Size: 50x35x27CM
 NW: 13KG



SKU: 905



Fog Machine Hand-held CO2 Gun

DJ CO2 Gun only needs a container with CO2. Easy to operate. This product is recommended for DJs, discos, bars and parties.

JET DIST: 6 m
NW: 3.2 kg

SKU: 901



LED Fog Machine 900W

Voltage: AC110-240V 50/60HZ
Power: 920W
Control: remote control
Re-heating time: 3 mins
LED: 3WX6pcs
Capacity of oil tanks 1.5L
Size:385x230x140mm
NW 4KG

SKU: 911



Water Low Fog Machine

Voltage: AC110-240V 50/60HZ
Power: 3000W
Cover area:150-200 square meter
Control:DMX512/remote control/manual
DMX Channel: 2
Consumable materials: water+heavy fog liquid
Capacity of fog tank: 3L
Capacity of water tank: 15L
Machine Size: 714x400x316mm
GW: 52KG

SKU: 908



Fog Machine 1000W

Voltage: AC110 - 240V 50/60HZ
Power: 1000W
Control: remote control/wire control
Re-heating time: 5 mins
Capacity of oil tanks 1 L
Size: 360x200x130mm
NW: 4KG

SKU: 912



Dry Ice Machine 3000W

Voltage: AC110-240V 50/60HZ
Power: 3000W
Cover area: 100-200 square meter
Control: Manual
Consumable materials: Dry ice and water
Machine Size: 660x 370x580mm
NW: 16KG

SKU: 909



Fog Machine 1500W

Voltage AC110 240V 50/60HZ
Power: 1500W
Control:remote contro/DMX 512
Re-heating time: 5 mins
Capacity of oil tanks 3 L
Size 510x260x150mm
NW: 6KG

SKU: 913



Fog Machine 900W

Voltage AC220V-240V 50/60HZ
Power: 900W
Control:remote control/wire control
Re-heating time 5 mins
Capacity of oil tanks 1.5L
Body color: black with hanging bracket
Machine Size:36.5x18.5x17cm
NW 3KG

SKU: 910



LED Fog Machine 1500W

Voltage: AC110-240V 50/60HZ
Power: 1520W
Control: remote contro/wire control/ time
Re-heating time: 5 mins
Capacity of oil tanks: 2.5 L
Machine Size: 540x330x260mm
NW: 6KG

SKU: 914





900W Fog Machine Remote

Voltage: AC220V-240V 50/60HZ
 Power: 900W
 Control: remote control/wire control
 Re-heating time: 40s
 Capacity of oil tanks: 1.5L
 Body color: black with hanging bracket
 Machine Size: 530×270×320mm
 Weight: 3KG

SKU: 910.2



IP20



DMX384 Moving Light Control

DMX384 moving light control DMX512 controller for controlling spectacular stage lighting.

Channels: 384
 DMX input/output: 3 pin male/female XLR
 Power supply: DC 9V 1000mA
 Dimensions: 520mm×183mm×73mm
 Weight: 2.6 kg

SKU: 696



IP20



300W Bubble Machine

Voltage: AC 110/230V 50-60Hz ± 10%
 Power: 200W
 Bubble Oil Capacity: 2.5L
 Bubble covered area: 200 m²
 Control: Remote control (30) meters, manual
 Product Dimensions: 415×250×415mm
 Weight: 12 kg

SKU: 968



IP20



Wireless DMX512 Controller

Input voltage: 9-12V DC 300mA min
 Communication distance: 700m (visible distance)
 Operating frequency: 2.4G ISM, 126 frequency band
 Maximum transmission power: 20dBm
 Receive sensitivity: -94dBm
 DMX signal output: 3/5 pin XLR
 Dimensions: 75 x 147 x 43mm
 Weight: 360g

SKU: 662



IP20



LED RGB CO2 Machine

LEDs: 12x3w RGB 3 in 1
 Voltage: AC220/110V 50/60HZ
 Power: 250W
 Control: DMX512, remote control
 DMX channels: 9
 Column height: 8-10 m
 Machine Size: 310×310×430 mm
 Weight: 7.0KG

SKU: 664



RGB



IP20



DMX Power Splitter

3 pin XLR IN/OUT
 Power: 15W
 Output: 4 or 8 DMX
 Size: 430x50x180mm
 Net weight: 2.35kg

SKU: 694 Output: 4 DMX

SKU: 695 Output: 8 DMX



IP20



Fog Machine 3000W

Voltage: AC110~240V 50/60HZ
 Power: 3000W
 Control: DMX512/remote control
 Re-heating time: 5 mins
 Capacity of oil tanks: 5L
 Size: 68x31x20CM
 NW: 13KG

SKU: 915



FOG



Portable Haze Machine

Voltage: AC110~240V 50/60HZ
 Power: 1500W
 Re-heating time: 45 sec
 Control: DMX512/ Remote control/Manual
 Use consumables: Water based haze liquid
 Capacity of oil tank: 2L
 Size: 325x153x340mm
 NW: 8KG

SKU: 916



HAZE



Hanging Type Haze Machine

Voltage: AC110~240V 50/60HZ
 Power: 1000W
 Warm-up time: 30 sec
 Control: DMX512/ Remote control/Manual
 Use consumables: Water based haze liquid
 Capacity of oil tank: 2L
 Weight: 9kg
 Size: 440x340x340mm

SKU: 917



HAZE



Oil Based Haze Machine

Voltage: AC110~240V 50/60HZ
 Power: 650W
 Re-heating time: 0 second
 Capacity of oil tank: 2.5L
 Control: DMX-512, remote control, Manual
 Machine size: 590x450x450mm
 NW: 23KG

SKU: 918



HAZE



Hand Confetti Machine

Voltage: AC110~240V 50/60HZ
 Confetti capacity: 0.5kg
 Control: Manual
 Use consumables: Bullion paper/Color paper
 Gas: Co2/N2
 Weight: 7kg
 Size: 970x300x210mm

SKU: 906



Confetti



LED Electric Confetti Machine

Voltage: AC110~240V 50/60HZ
 Power: 1236W
 Control: DMX 512, remote control
 Height of ejection: 6-8M
 DMX Channel: 7
 Confetti capacity: 0.5KG
 Size: 280x280x550mm
 NW: 8KG

SKU: 907



Light



Confetti



OPTONICA COMFORT PRODUCTS



WiFi E27 SMART CAMERA BULB

Video resolution: HD
Frame rate: 25fps
View angle: 360 degrees (Horizontal)
90 degrees (Vertical)
Motion detection: About 5 meters
Night vision: About 5 meters
Max memory: Up to 128Gb (Not Include)
App: JXLCAM

SKU: 227



E27



IP20



WiFi SMART CAMERA BULB

Video resolution: HD
Frame rate: 25fps
View angle: 360 degrees (Horizontal)
90 degrees (Vertical)
Motion detection: About 5 meters
Night vision: About 5 meters
Max memory: Up to 128Gb (Not Include)
App: JXLCAM

SKU: 244



EU Plug Socket



IP20



Window cleaning
Robot

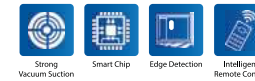

Window cleaning
Robot

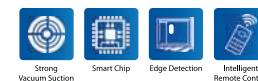

Cleaning speed 2 minutes / m2
Power 80W
Size 300x150x120mm
Cleaning Modes 3 modes

SKU: 757



Cleaning speed 2 minutes / m2
Power 80W
Size 250x250x9.5mm
Cleaning Modes 3 modes
UPS 20min

SKU: 758



Air Purifier & Humidifier

Breathe Cleaner and Healthier Air

7 Stage Air Purification + Humidifier
UV Lamp and IONIZER + WIFI

CADR(PM2.5)	450m ³ /h
Power	85W
Area	~50 m ²
Size	400x230x620mm
Purification	Pre-filter, Cold-catalyst, Formaldehyde removal filter (Honeycomb activated carbon filter Optional), Antibacterial filter, UV Sterilization, HEPA filter, Anion release.
SKU: 733	3800156607330



Air Purifier

Breathe Cleaner and Healthier Air

6 Stage Air Purification
UV Lamp and IONIZER

CADR(PM2.5)	150m ³ /h
Power	43W
Area	~30 m ²
Size	330x180x505mm
Purification	Cold-catalyst, Formaldehyde removal filter (Honeycomb activated carbon filter Optional), Antibacterial filter, UV Sterilization, HEPA filter, Anion release.
SKU: 731	3800156607316



Air Purifier & Humidifier

Breathe Cleaner and Healthier Air

6 Stage Air Purification + Humidifier
UV Lamp and IONIZER

CADR(PM2.5)	300m ³ /h
Power	65W
Area	~38 m ²
Size	360x195x565(mm)
Purification	Cold-catalyst, Formaldehyde removal filter (Honeycomb activated carbon filter Optional), Antibacterial filter, UV Sterilization, HEPA filter, Anion release.
SKU: 732	3800156607323



Air Purifier

Breathe Cleaner and Healthier Air

7 Stage Air Purification
UV Lamp and IONIZER

CADR(PM2.5)	320m ³ /h
Power	80W
Area	~40 m ²
Size	370x195x605mm
Purification	Pre-filter, Cold-catalyst, Formaldehyde removal filter (Honeycomb activated carbon filter Optional), Antibacterial filter, UV Sterilization, HEPA filter, Anion release.
SKU: 734	3800156607347





LED FLOOR LIGHT
20W - Remote Control



Watts	20W	CRI	Ra>80
Input Voltage	AC : 220-240V	IP Rating	IP20
Flux	500lm	Dimension	130x1045 mm
Beam Angle	120°	Dimmable	YES

SKU: 237
RGB+3000K

DIY modular assembly
Multiple mode changes



LED FLOOR LIGHT
17W - Remote Control



Watts	17W	CRI	Ra>80
Input Voltage	AC : 220-240V	IP Rating	IP20
Flux	400lm	Dimension	φ23.5x1462 mm
Beam Angle	120°	Dimmable	YES

SKU: 238
RGB+3000K

DIY modular assembly
Multiple mode changes

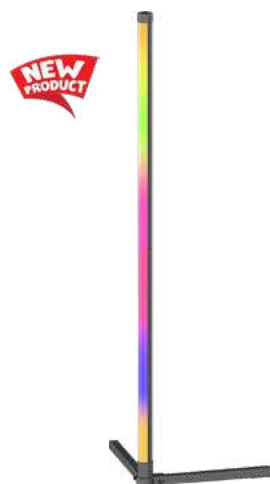

LED FLOOR LIGHT 5V
8W - Remote Control



* AC Adapter NOT Included

Watts	8W	CRI	Ra>80
Input Voltage	DC 5V 2A	IP Rating	IP20
Flux	220lm	Dimension	φ30x1047 mm
Beam Angle	120°	Dimmable	YES

SKU: 239
RGB+6000K

DIY modular assembly
Multiple mode changes



POWER BANK - WATERPROOF
10000 mAh



Battery: 10000MAh
Rated Power: 37Wh/3.7V
Input Micro :5V/2A
Input Type-C: 5V/3A
Output USB1/2 t: 5V/3A
Output Type-C : 5V/3A
Solar Panel:1.2W
Size: 159*78*19.5mm
Flashlight:2W LED

SKU: 7691 Black Body



POWER BANK - WATERPROOF
20000 mAh



Battery: 20000MAh
Rated Power: 74wh/3.7V
Input Micro :5V/2A
Input Type-C: 5V/3A
Output USB1/2 t: 5V/3A
Output Type-C : 5V/3A
Solr Panel:1.2W
Product Size: 167*86*33.5mm
Flashlight:4w Led

SKU: 7692 Black Body



POWER BANK
10000 mAh



Battery: 10000mAh
Rated Power: 3.7V/37Wh
Input Micro :1 DC 5V/2A | 9V/2A | 12V/1.5A
Input Type-C :2 DC 5V/3A | 9V/2A | 12V/1.5A
Output1 Type-C DC 5V/3A | 9V/2A | 12V/1.5A
Output2 USB-A/B DC 4.5V/5A | 5V/4A | 9V/2A
Product Size: 140*69*15.5mm

SKU: 7693 White Body
SKU: 7694 Black Body



POWER BANK
20000 mAh



Battery: 20000mAh
Rated Power: 3.7V/74Wh
Input Micro :1 DC 5V/2A | 9V/2A | 12V/1.5A
Input Type-C :2 DC 5V/3A | 9V/2A | 12V/1.5A
Output1 Type-C DC 5V/3A | 9V/2A | 12V/1.5A
Output2 USB-A/B DC 4.5V/5A | 5V/4A | 9V/2A
Product Size: 140*69*27.5mm

SKU: 7695 Black Body

SMART CAMERA ROBOTIC VACUUM CLEANER

SKU: 752



BRUSHLESS VACUUM MOTOR+ROLLER BRUSH
Clean thoroughly

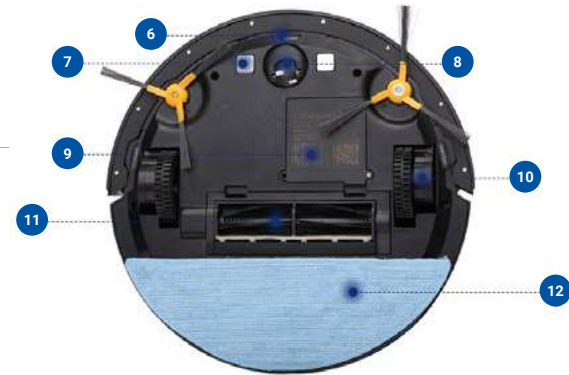

1 Side Brush	2 Power Button	3 Camera	4 Power Switch
5 Glass Cover	6 Anti-drop Sensor	7 Charging Connect	8 Universal Wheel
9 Battery Cover	10 Wheel	11 Roller Brush	12 Mop

Working Time Per Charge: 80-120mins

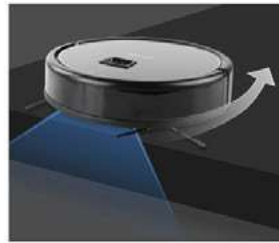

ANTI-DROP SENSORS

Keep machine safety away from stairs

ANTI-COLLISION SENSORS

Effective protect machine and furniture



EASY CLIMBING

Moves over thresholds

GO TO CLEAN UNDER THE FURNITURE

Without omission



AUTOMATIC CHARGING

Back to charging dock automatically when battery is low

BREAKPOINT RESUME OPERATION

After charging, machine returns to breakpoint, continue to clean the remaining area.



SMART GYRO ROBOTIC VACUUM CLEANER

SKU: 753



**GYROSCOPE NAVIGATION
MULTIPLE CLEANING MODES**

AUTO CLEANING ROBOTIC VACUUM CLEANER

SKU: 754



ROADROVER WHEELS

Climbing ability reach 2cm
With cross-country wheel,
Easy go crossing the obstacle

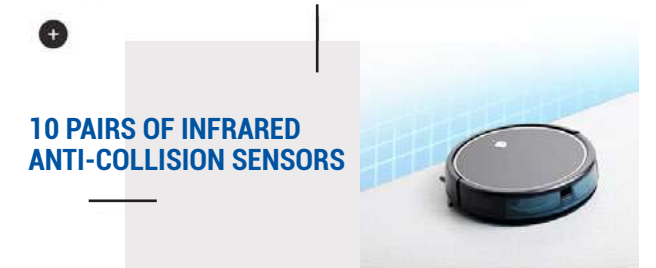

10 PAIRS OF INFRARED ANTI-COLLISION SENSORS



AUTOMATIC DOCK AND CHARGING



STRONG SUCTION
Up to 1000PA, no dust can hide from it



VARIOUS GROUND TYPE APPLICATION

Suitable for various floor type, low pile carpet, tile, wood floor, etc

3 in 1 Wireless Charging Station
Apple iPhone/AirPods/iWatch
Samsung Phone/Buds/Watch



Wireless Charging IP20

3-in-1 Wireless Charging

Compact Design

Phone Stand

SKU: 9500 For iPhone
SKU: 9501 For Samsung

3 in 1 Multifunction Desk Lamp
Wireless Charging



Wireless Charging IP20

3-in-1 Wireless Charging

Phone Stand

SKU: 9512 Black Body

6 in 1 Multi-function Charging Station
Match multiple devices



Wireless Charging IP20

for phone for iWatch for AirPods

SKU: 9502 Black Body
SKU: 9503 White Body

3 USB Quick Charger
36W Max Power PD + 3USB IP20



quick charge 3 USB ports PD 20W smart chip

SKU: 9510 Black Body
SKU: 9511 White Body

Wireless Charger Pad
Qi Standard



Compact Design Wireless Charging IP20

● Universal input: 5.0V=2A Universal output: 5.0V 1A
● Fast charge input: 9.0V 2A Fast charge output: 9.0V 1.2A

SKU: 9508 Black Body
SKU: 9509 White Body

Car Wireless Charger Stand
36W Max Power



Wireless Charging IP20

10W Wireless charging Steady Large area induction coil

SKU: 9506 Gold Body
SKU: 9507 Silver Body

Wireless Charging Clock supports iOS and Android

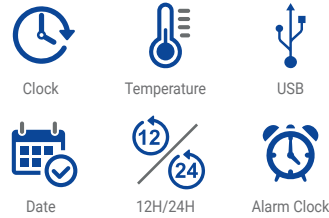

SKU: 9514 Clock

Solar Portable Bluetooth Speaker + Lamp
Solar Panel Power: 5V/3.5W



- SOS Emergency Light
- Power Bank Function
- USB Ports

Battery
3.7V 6Ah

SKU: 223
CCT
6000K 4500K 3000K



Bluetooth FM Transmitter Car Charger With MP3 Player

SKU: 9504 FM Transmitter



3 in 1 Magnetic USB Cable
Type-C, Micro USB, For Apple



SKU: 9516 Charging Cable

Solar Portable Bluetooth Speaker + Lamp
Solar Panel Power: 5V/3.5W



- SOS Emergency Light
- Power Bank Function
- USB Ports

Battery
3.7V 6Ah

SKU: 224
CCT
6000K 4500K 3000K



CCT Selfie Ring Light
10W 5V USB - Dimmable



Watts 10W
Input Voltage 5V USB
Flux 800lm
Beam Angle 120°
Dimmable YES

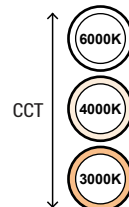

SKU: 9515 Selfie Ring Light

Solar Portable Bluetooth Speaker + Lamp
Solar Panel Power: 5V/3.5W



- SOS Emergency Light
- Power Bank Function
- USB Ports

Battery
3.7V 6Ah

SKU: 228
CCT
6000K 4500K 3000K





NEW PRODUCT

SKU: 7601 - 3 Sockets 1.5m 16A
SKU: 7602 - 3 Sockets 3m 16A

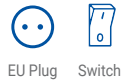

NEW PRODUCT

SKU: 7607 - 3 Sockets 1.5m 16A
SKU: 7608 - 3 Sockets 3m 16A

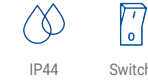

NEW PRODUCT

SKU: 7613 - 4 Sockets 5m 16A



NEW PRODUCT

SKU: 7614 - 6 Sockets 10m 16A



NEW PRODUCT

SKU: 7603 - 4 Sockets 1.5m 16A
SKU: 7604 - 4 Sockets 3m 16A

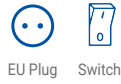

NEW PRODUCT

SKU: 7609 - 4 Sockets 1.5m 16A
SKU: 7610 - 4 Sockets 3m 16A

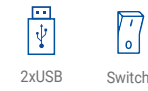

NEW PRODUCT

SKU: 7615 - 3 Sockets 1.5m 16A



NEW PRODUCT

SKU: 7616 - 5 Sockets 1.5m 16A



NEW PRODUCT

SKU: 7605 - 5 Sockets 1.5m 16A
SKU: 7606 - 5 Sockets 3m 16A

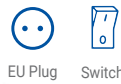

NEW PRODUCT

SKU: 7611 - 5 Sockets 1.5m 16A
SKU: 7612 - 5 Sockets 3m 16A

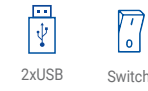

NEW PRODUCT

SKU: 7617 - 3 Sockets 3m 16A



NEW PRODUCT

SKU: 7618 - 5 Sockets 3m 16A

Reel: 1000W(4.35A)
Unreel: 3200W(13.91A)



SKU: 7623 - 4 Sockets 25m 16A

Reel: 1100W(4.8A)
Unreel: 3200W(13.91A)



SKU: 7624 - 4 Sockets 10m 16A



SKU: 7631 - Schuko Male 16A



SKU: 7632 - Schuko Female 16A



SKU: 7625 - 2 Sockets 5m 16A



SKU: 7626 - 2 Sockets 5m 16A



SKU: 7633 - Schuko Male 16A



SKU: 7634 - Schuko Female 16A



SKU: 7635 - 2 Sockets Adapter 16A



SKU: 7637 - 2 Sockets Adapter 16A



SKU: 7621 - 1 Sockets 10m 16A
SKU: 7622 - 1 Sockets 20m 16A



SKU: 7636 - 3 Sockets 16A

SKU:	Page No.	SKU:	Page No.	SKU:	Page No.	SKU:	Page No.	SKU:	Page No.	SKU:	Page No.	SKU:	Page No.	SKU:	Page No.	SKU:	Page No.	SKU:	Page No.	SKU:	Page No.	SKU:	Page No.	SKU:	Page No.
101	439	507	417	618	440	734	487	950	446	1267	61	1360	47	1477	40	1711	45	1854	36	1922	54	2014	75		
102	443	515	417	619	440	752	490	951	455	1268	61	1361	47	1478	40	1718	67	1855	36	1923	54	2015	75		
112	447	516	417	620	441	753	491	952	444	1269	61	1362	47	1479	40	1719	67	1856	36	1929	62	2016	75		
113	447	517	417	621	445	754	491	960	476	1270	61	1363	48	1480	43	1720	67	1857	36	1930	62	2017	81		
114	449	550	417	622	444	757	485	961	476	1271	61	1364	48	1481	43	1721	67	1858	36	1931	62	2018	81		
115	451	551	417	623	443	758	485	962	476	1272	61	1365	48	1482	43	1722	67	1859	36	1932	63	2019	81		
116	452	565	413	624	443	856	412	963	476	1273	61	1401	53	1490	42	1723	67	1860	40	1933	63	2020	81		
117	452	566	413	628	443	863	415	964	470	1274	61	1402	53	1491	43	1724	67	1861	40	1934	63	2021	82		
123	471	567	413	629	436	864	415	965	470	1305	35	1403	53	1492	41	1725	67	1862	40	1935	62	2022	82		
124	471	568	413	630	436	865	415	966	470	1306	35	1404	53	1493	53	1726	67	1863	40	1936	62	2023	82		
125	471	571	416	631	436	866	414	967	459	1308	36	1405	53	1494	53	1742	66	1864	38	1937	62	2024	82		
126	474	572	416	635	438	867	414	968	480	1309	36	1406	53	1495	53	1743	66	1865	38	1938	63	2025	83		
128	459	573	416	636	438	868	414	969	481	1310	37	1407	51	1516	57	1744	66	1866	38	1939	63	2026	83		
129	459	580	415	638	437	872	414	972	447	1311	37	1408	51	1517	57	1745	66	1867	39	1940	63	2027	80		
149	447	581	415	639	437	873	414	973	469	1312	37	1409	51	1518	57	1746	66	1868	39	1943	63	2028	80		
150	448	582	415	640	437	874	414	974	468	1313	38	1410	44	1519	57	1747	66	1869	39	1945	64	2029	80		
151	448	583	415	650	446	879	415	975	468	1314	38	1411	44	1528	50	1748	67	1872	41	1946	64	2030	80		
152	451	584	415	651	446	901	478	976	469	1315	38	1412	44	1529	50	1749	67	1876	50	1947	64	2031	76		
153	450	585	415	652	446	902	477	977	468	1316	38	1413	42	1530	50	1750	67	1877	50	1950	55	2032	76		
164	458	586	412	653	446	903	477	981	472	1317	38	1414	44	1531	58	1761	68	1878	50	1951	55	2033	76		
165	458	587	412	654	446	904	477	982	472	1318	38	1415	43	1532	58	1762	68	1879	34	1952	55	2034	76		
166	458	588	412	655	446	905	477	983	472	1319	38	1416	43	1533	58	1763	68	1880	34	1953	55	2035	77		
171	450	589	412	656	454	906	483	984	473	1320	38	1417	41	1534	58	1764	68	1884	49	1954	55	2036	77		
177	456	590	412	661	453	907	483	985	475	1321	38	1418	41	1535	58	1765	68	1885	49	1955	55	2037	77		
221	367	591	413	662	481	908	478	986	473	1322	35	1422	51	1536	58	1766	68	1886	49	1956	55	2038	77		
222	158	592	415	664	480	909	478	988	463	1323	37	1423	51	1541	58	1767	68	1887	33	1957	60	2039	78		
223	495	593	415	671	445	910	478	990	463	1324	37	1424	51	1542	58	1768	68	1888	33	1958	60	2040	78		
224	495	594	413	678	476	910.2	480	992	462	1325	39	1425	51	1543	58	1769	68	1889	33	1959	60	2041	78		
225	367	595	413	679	476	911	479	993	462	1326	39	1426	51	1615	56	1770	68	1890	33	1960	60	2042	78		
226	367	596	414	681	474	912	479	994	462	1327	48	1427	51	1616	56	1772	68	1893	34	1961	60	2043	78		
227	484	597	414	682	475	913	479	995	463	1328	48	1428	52	1617	56	1773	68	1896	34	1962	60	2044	78		
228	495	598	414	683	456	914	479	1056	56	1329	48	1429	52	1638	56	1790	32	1899	36	1963	60	2045	83		
229	65	599	414	684	474	915	482	1067	56	1336	49	1430	52	1639	56	1791	32	1901	62	1964	60	2046	83		
230	389	601	436	685	465	916	482	1068	56	1337	49	1435	52	1640	56	1792	32	1902	62	1965	60	2047	73		
231	389	602	436	686	465	917	482	1163	59	1338	49	1436	52	1644	56	1793	32	1903	62	1970	64	2048	73		
232	389	603	436	687	465	918	482	1164	59	1341	46	1437	52	1645	56	1794	39	1904	62	1971	64	2049	73		
233	389	604	436	688	475	932	461	1167	59	1342	46	1438	53	1646	56	1795	35	1905	62	1972	64	2050	73		
234	389	605	436	689	473	933	476	1168	59	1343	46	1439	53	1651	57	1796	37	1906	62	2001	79	2051	73		
235	389	606	436	690	457	935	464	1169	59	1344	48	1440	53	1652	57	1819	50	1907	64	2002	79	2052	73		
236	389	607	440	691	457	936	461	1170	59	1345	48	1463	51	1653	57	1838	48	1908	64	2003	79	2060	84		
237	488	608	436	692	457	937	464	1191	59	1346	48	1464	51	1654	57	1839	48	1909	64	2004	79	2061	84		
238	488	609	436	693	476	938	464	1192	59	1351	45	1465	51	1655	57	1840	48	1910	54	2005	79	2062	84		
239	488	610	437	694	481	940	460	1193	59	1352	45	1469	42	1656	57	1841	49	1914	54	2006	79	2063	84		
240	388	611	437	695	481	941	460	1194	59	1353	45	1470	42	1701	46	1842	49	1915	54	2007	79	2064	85		
241	388	612	437	697	476	943	456	1195	59	1354	46	1471	42	1702	46	1843	49	1916	55	2008	79	2065	85		
242	388	613	441	698	476	945	460	1196	59	1355	46	1472	42	1703	46	1845	49	1917	55	2009	72	2066	85		
243	388	614	441	699	476	946	453	1263	61	1356	46	1473	42	1704	47	1846	49	1918	54	2010	72	2067	85		
244	484	615	441	731	487	947	449	1264	61	1357	47	1474	40	1705	47	1847	49	1919	54	2011	72	2068	86		
501	417	616	441	732	486	948	448	1265	61	1358	47	1475	40	1706	47	1849	46	1920	54	2012	72	2069	86		
502	417	617	440	733	486	949	455	1266	61	1359	47	1476	40	1710	45	1851	47	1921	54	2013	75	2070	86		

SKU:	Page No.	SKU:	Page No.	SKU:	Page No.	SKU:	Page No.	SKU:	Page No.	SKU:	Page No.	SKU:	Page No.	SKU:	Page No.	SKU:	Page No.	SKU:	Page No.	SKU:	Page No.	SKU:	Page No.
5941	331	6117	252	6271	244	6357	279	6509	343	6632	239	6711	109	7312	433	7454	382	7508	384	7622	499	8208	362
5942	331	6119	250	6272	244	6358	279	6510	343	6633	239	6712	109	7313	432	7455	382	7509	385	7623	498	8211	363
5943	331	6120	250	6273	244	6359	263	6511	343	6634	237	6721	113	7314	433	7456	382	7510	385	7624	498	8212	363
5944	331	6121	252	6281	244	6360	263	6512	343	6635	237	6722	113	7315	431	7457	382	7511	385	7625	498	8213	363
5945	331	6124	252	6282	244	6361	279	6541	216	6636	237	6723	113	7316	431	7458	382	7512	385	7626	498	8214	363
5946	331	6131	254	6283	244	6362	279	6542	216	6637	237	6724	113	7317	426	7459	382	7513	385	7631	499	8215	363
5947	331	6132	254	6284	245	6363	277	6543	238	6638	237	6725	113	7318	428	7460	382	7514	385	7632	499	8216	363
5948	331	6133	254	6285	245	6364	274	6544	238	6639	237	6726	113	7319	428	7461	382	7515	386	7633	499	8217	363
5949	331	6134	254	6302	258	6365	276	6545	238	6640	237	6731	106	7320	426	7462	382	7516	386	7634	499	8218	363
5950	331	6135	254	6303	258	6366	274	6546	238	6641	343	6732	106	7321	426	7463	381	7517	386	7635	498	8221	359
5951	331	6151	253	6304	258	6367	274	6547	238	6642	343	6733	107	7322	429	7464	381	7518	386	7636	499	8222	359
5952	333	6152	253	6305	259	6368	263	6548	238	6643	343	6734	107	7323	429	7465	381	7519	386	7637	498	8223	359
5953	333	6153	253	6306	258	6369	275	6549	217	6644	343	6735	106	7395	489	7466	381	7520	386	7691	489	8224	359
5954	333	6154	253	6307	258	6370	276	6550	217	6645	343	6736	106	7401	394	7467	381	7521	387	7692	489	8225	359
5955	333	6155	253	6308	260	6371	275	6551	217	6646	343	6737	107	7402	394	7468	381	7522	387	7693	489	8226	359
5956	333	6161	255	6310	259	6372	275	6552	217	6647	342	6738	107	7403	377	7469	380	7523	387	7694	489	8231	358
5957	333	6162	255	6311	259	6374	264	6553	217	6648	342	6739	106	7404	377	7470	380	7524	387	8123	361	8232	358
5958	333	6163	255	6312	260	6375	264	6554	217	6671	111	6740	106	7405	399	7471	380	7525	387	8140	361	8233	358
5959	333	6164	255	6314	260	6376	264	6555	217	6672	111	6741	107	7406	399	7472	380	7526	377	8141	361	8234	358
5960	333	6165	255	6315	260	6377	264	6556	217	6673	111	6742	107	7407	372	7473	380	7527	377	8151	366	8235	358
5961	333	6191	454	6317	261	6378	269	6557	217	6674	111	6745	110	7408	373	7474	380	7528	376	8152	366	8236	358
5962	333	6192	454	6318	261	6379	265	6558	217	6675	111	6746	110	7409	372	7475	378	7529	376	8153	366	8237	358
6019	174	6201	246	6319	261	6380	266	6562	217	6676	111	6747	110	7410	373	7476	378	7530	376	8154	366	8238	358
6021	174	6202	246	6320	261	6381	265	6563	217	6677	111	6748	110	7411	372	7477	378	7531	376	8155	366	9004	153
6022	174	6203	246	6321	273	6382	265	6564	217	6678	111	7131	368	7412	373	7478	378	7532	376	8156	366	9005	153
6025	189	6206	246	6322	273	6383	266	6565	217	6679	111	7132	368	7422	394	7479	378	7533	376	8157	366	9008	154
6026	189	6207	246	6326	259	6384	266	6566	217	6680	111	7133	368	7423	394	7480	378	7534	376	8158	366	9009	154
6027	189	6208	246	6328	259	6385	269	6601	236	6681	111	7134	368	7431	396	7481	379	7535	376	8166	364	9011	154
6028	173	6211	247	6329	260	6386	262	6602	236	6682	341	7135	368	7432	396	7482	379	7541	392	8167	364	9014	153
6029	173	6212	247	6331	223	6387	262	6603	236	6683	341	7136	368	7433	396	7483	379	7542	392	8168	364	9015	153
6030	173	6213	247	6332	223	6388	265	6604	236	6684	341	7201	118	7434	397	7484	379	7543	392	8169	364	9017	156
6031	173	6214	247	6335	270	6389	269	6605	236	6685	341	7202	118	7435	397	7485	379	7601	496	8170	364	9018	156
6032	173	6221	247	6336	272	6390	267	6608	221	6686	342	7203	117	7436	397	7486	379	7602	496	8171	364	9019	155
6035	174	6222	247	6337	272	6391	267	6610	221	6687	342	7204	117	7437	396	7487	383	7603	496	8172	364	9020	155
6036	174	6223	247	6338	272	6392	267	6611	221	6691	112	7205	117	7438	396	7488	383	7604	496	8173	364	9021	155
6037	174	6224	247	6339	272	6393	268	6612	221	6692	112	7206	117	7439	396	7489	383	7605	496	8175	365	9022	157
6038	174	6231	248	6340	270	6394	268	6613	221	6694	112	7207	118	7440	397	7490	383	7606	496	8177	365	9024	157
6039	174	6232	248	6341	270	6395	266	6614	221	6695	112	7208	119	7441	397	7491	383	7607	496	8178	365	9026	157
6101	250	6233	248	6342	273	6396	267	6615	221	6697	112	7209	119	7442	397	7492	383	7608	496	8179	365	9027	156
6102	250	6241	248	6343	271	6397	268	6616	221	6698	112	7210	119	7443	395	7493	383	7609	496	8181	365	9028	152
6103	250	6242	248	6345	270	6398	278	6617	221	6701	108	7211	119	7444	395	7494	383	7610	496	8190	360	9029	152
6104	252	6243	248	6348	262	6399	278	6618	221	6702	108	7301	424	7445	395	7495	383	7611	496	8191	360	9036	150
6105	252	6251	249	6349	262	6501	342	6619	221	6703	109	7302	424	7446	395	7496	383	7612	496	8192	360	9037	150
6106	252	6252	249	6350	263	6502	342	6620	221	6704	109	7304	430	7447	395	7497	383	7613	497	8201	362	9038	151
6108	252	6253	249	6351	278	6503	342	6621	221	6705	108	7305	426	7448	395	7498	383	7614	497	8202	362	9039	151
6109	252	6254	249	6352	271	6504	342	6622	212	6706	108	7306	425	7449	396	7503	384	7615	497	8203	362	9041	158
6110	251	6261	249	6353	271	6505	342	6623	212	6707	109	7307	425	7450	396	7504	384	7616	497	8204	362	9042	158
6111	251	6262	249	6354	277	6506	342	6624	212	6708	109	7309	430	7451	382	7505	384	7617	497	8205	362	9043	159
6112	251	6263	249	6355	276	6507	342	6627	239	6709	108	7310	427	7452	382	7506	384	7618	497	8206	362	9044	159
6114	252	6264	249	6356	277	6508	342	6631	239	6710	108	7311	427	7453	382	7507	384	7621	499	8207	362	9045	159

SKU:	Page No.	SKU:	Page No.	SKU:	Page No.	SKU:	Page No.	SKU:	Page No.	SKU:	Page No.
9046	152	9128	347	9304	2408	9406	12	9500	492	5611-m	104
9047	152	9129	347	9305	409	9407	13	9501	492	5612-m	104
9048	152	9135	348	9306	409	9408	14	9502	492	5613-m	104
9049	152	9136	348	9307	409	9410	17	9503	492	5623-m	104
9050	90	9137	349	9308	409	9411	16	9504	494	5624-m	104
9051	90	9138	349	9309	410	9412	18	9506	493	5643-m	104
9052	90	9141	346	9310	410	9413	19	9507	493		
9053	90	9142	346	9311	410	9418	8	9508	492		
9054	90	9143	346	9312	410	9419	8	9509	492		
9055	90	9156	354	9315	411	9420	8	9510	493		
9056	90	9157	354	9316	411	9421	8	9511	493		
9057	90	9158	354	9321	399	9422	8	9512	493		
9058	91	9171	355	9322	399	9423	8	9514	494		
9059	91	9172	355	9323	399	9424	11	9515	494		
9060	91	9173	355	9324	399	9425	11	9516	494		
9061	91	9174	355	9331	404	9426	11	9601	28		
9062	92	9175	357	9332	404	9427	11	9602	28		
9063	92	9176	357	9333	404	9428	8	9603	29		
9064	92	9177	357	9334	405	9429	8	9604	29		
9065	92	9178	357	9335	405	9431	10	9605	29		
9066	92	9179	352	9336	405	9434	13	9606	29		
9067	93	9180	352	9337	406	9435	25	9607	29		
9068	93	9181	356	9338	406	9436	25	9608	29		
9069	93	9182	356	9339	406	9437	24	9609	29		
9070	93	9196	353	9340	407	9438	24	9610	28		
9071	93	9197	353	9341	407	9439	28	9611	29		
9072	88	9198	353	9342	407	9451	12	9612	29		
9073	88	9199	353	9343	393	9452	12	9613	29		
9074	89	9201	351	9344	403	9453	12	9614	29		
9075	89	9202	351	9345	393	9454	12	9615	29		
9076	88	9203	351	9346	403	9455	13	9616	29		
9077	88	9204	351	9347	393	9456	13	9656	20		
9078	89	9205	351	9348	403	9457	12	9658	21		
9079	89	9206	351	9349	400	9458	12	9659	21		
9080	94	9207	351	9350	400	9461	23	66018	438		
9081	94	9208	351	9351	400	9462	23	66019	438		
9082	94	9209	351	9352	401	9463	23	66020	439		
9083	94	9210	351	9353	401	9464	13	66024	445		
9084	95	9211	351	9354	401	9471	22	66025	442		
9085	95	9212	351	9355	398	9472	22	66026	442		
9086	95	9213	351	9356	398	9473	22	66027	442		
9087	95	9214	351	9357	402	9481	26	66028	442		
9092	419	9215	351	9358	402	9482	26	66122	466		
9093	419	9221	350	9359	402	9483	26	66123	466		
9094	419	9222	350	9400	9	9484	26	66124	467		
9095	419	9223	350	9401	9	9485	26	66125	467		
9118	356	9224	350	9402	9	9491	27	66126	466		
9119	356	9301	408	9403	11	9492	27	66127	461		
9126	347	9302	408	9404	10	9493	27	5611-m	104		
9127	347	9303	408	9405	15	9494	27	5612-m	104		

SKU:	Page No.	SKU:	Page No.	SKU:	Page No.	SKU:	Page No.	SKU:	Page No.	SKU:	Page No.
9046	152	9128	347	9304	2408	9406	12	9500	492	5611-m	104
9047	152	9129	347	9305	409	9407	13	9501	492	5612-m	104
9048	152	9135	348	9306	409	9408	14	9502	492	5613-m	104
9049	152	9136	348	9307	409	9410	17	9503	492	5623-m	104
9050	90	9137	349	9308	409	9411	16	9504	494	5624-m	104
9051	90	9138	349	9309	410	9412	18	9506	493	5643-m	104
9052	90	9141	346	9310	410	9413	19	9507	493		
9053	90	9142	346	9311	410	9418	8	9508	492		
9054	90	9143	346	9312	410	9419	8	9509	492		
9055	90	9156	354	9315	411	9420	8	9510	493		
9056	90	9157	354	9316	411	9421	8	9511	493		
9057	90	9158	354	9321	399	9422	8	9512	493		
9058	91	9171	355	9322	399	9423	8	9514	494		
9059	91	9172	355	9323	399	9424	11	9515	494		
9060	91	9173	355	9324	399	9425	11	9516	494		
9061	91	9174	355	9331	404	9426	11	9601	28		
9062	92	9175	357	9332	404	9427	11	9602	28		
9063	92	9176	357	9333	404	9428	8	9603	29		
9064	92	9177	357	9334	405	9429	8	9604	29		
9065	92	9178	357	9335	405	9431	10	9605	29		
9066	92	9179	352	9336	405	9434	13	9606	29		
9067	93	9180	352	9337	406	9435	25	9607	29		
9068	93	9181	356	9338	406	9436	25	9608	29		
9069	93	9182	356	9339	406	9437	24	9609	29		
9070	93	9196	353	9340	407	9438	24	9610	28		
9071	93	9197	353	9341	407	9439	28	9611	29		
9072	88	9198	353	9342	407	9451	12	9612	29		
9073	88	9199	353	9343	393	9452	12	9613	29		
9074	89	9201	351	9344	403	9453	12	9614	29		
9075	89	9202	351	9345	393	9454	12	9615	29		
9076	88	9203	351	9346	403	9455	13	9616	29		
9077	88	9204	351	9347	393	9456	13	9656	20		
9078	89	9205	351	9348	403	9457	12	9658	21		
9079	89	9206	351	9349	400	9458	12	9659	21		
9080	94	9207	351	9350	400	9461	23	66018	438		
9081	94	9208	351	9351	400	9462	23	66019	438		
9082	94	9209	351	9352	401	9463	23	66020	439		
9083	94	9210	351	9353	401	9464	13	66024	445		
9084	95	9211	351	9354	401	9471	22	66025	442		
9085	95	9212	351	9355	398	9472	22	66026	442		
9086	95	9213	351	9356	398	9473	22	66027	442		
9087	95	9214	351	9357	402	9481	26	66028	442		
9092	419	9215	351	9358	402	9482	26	66122	466		
9093	419	9221	350	9359	402	9483	26	66123	466		
9094	419	9222	350	9400	9	9484	26	66124	467		
9095	419	9223	350	9401	9	9485	26	66125	467		
9118	356	9224	350	9402	9	9491	27	66126	466		
9119	356	9301	408	9403	11	9492	27	66127	461		
9126	347	9302	408	9404	10	9493	27	5611-m	104		
9127	347	9303	408	9405	15	9494	27	5612-m	104		

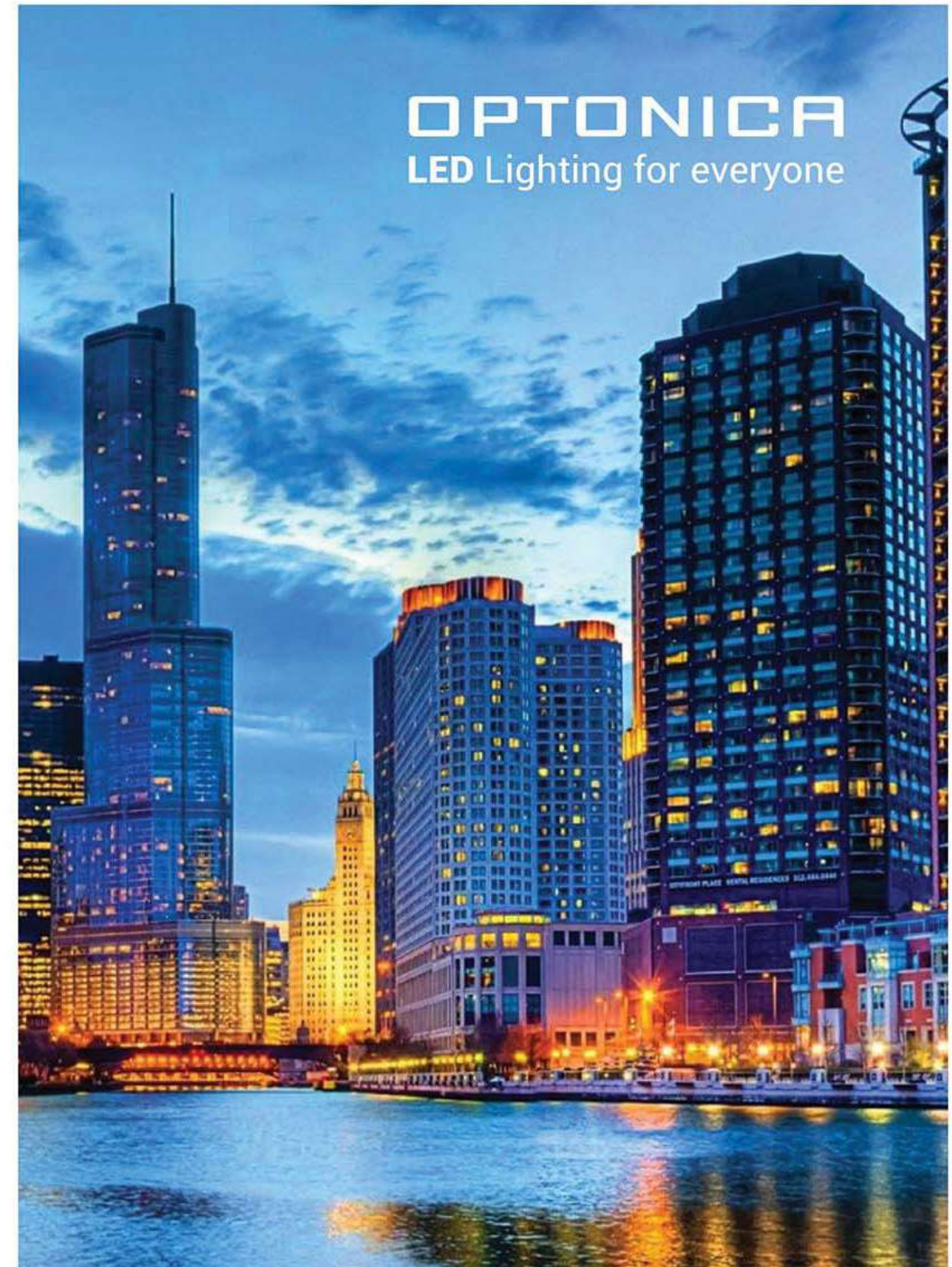



OPTONICA

www.optonicaled.com